



TESLA

# MODEL Y

## OWNER'S MANUAL



North America



Overview.....	2	Maintenance.....	168
Interior Overview.....	2	Maintenance Schedule.....	168
Exterior Overview.....	3	Tire Care and Maintenance.....	170
Touchscreen Overview.....	4	Cleaning.....	177
Opening and Closing.....	9	Wiper Blades and Washer Jets.....	180
Keys.....	9	Fluid Reservoirs.....	181
Doors.....	14	Jacking and Lifting.....	183
Windows.....	17	Parts and Accessories.....	184
Rear Trunk.....	18	Specifications.....	185
Front Trunk.....	20	Identification Labels.....	185
Interior Storage and Electronics.....	23	Vehicle Loading.....	186
Seating and Safety Restraints.....	28	Dimensions and Weights.....	188
Front and Rear Seats.....	28	Subsystems.....	190
Seat Belts.....	32	Wheels and Tires.....	194
Child Safety Seats.....	36	Roadside Assistance.....	202
Airbags.....	43	Contacting Tesla Roadside Assistance.....	202
Driving.....	50	Instructions for Transporters.....	203
Driver Profiles.....	50	Consumer Information.....	207
Steering Wheel.....	52	Easter Eggs.....	207
Mirrors.....	54	About this Owner Information.....	208
Starting and Powering Off.....	56	Disclaimers.....	210
Gears.....	58	Reporting Safety Defects.....	212
Lights.....	60	Declarations of Conformity.....	213
Car Status.....	64	Troubleshooting Alerts.....	215
Wipers and Washers.....	67		
Braking and Stopping.....	68		
Traction Control.....	72		
Park Assist.....	73		
Vehicle Hold.....	75		
Getting Maximum Range.....	76		
Rear View Camera.....	77		
Dashcam.....	78		
Cold Weather Best Practices.....	80		
Autopilot.....	82		
About Autopilot.....	82		
Traffic-Aware Cruise Control.....	85		
Autosteer.....	91		
Navigate on Autopilot.....	97		
Autopark.....	101		
Summon.....	103		
Smart Summon.....	106		
Lane Assist.....	110		
Collision Avoidance Assist.....	113		
Speed Assist.....	116		
Using the Touchscreen.....	118		
Controls.....	118		
Climate Controls.....	127		
Maps and Navigation.....	132		
Media and Audio.....	138		
Phone.....	141		
Calendar.....	143		
Using Voice Commands.....	144		
Security Settings.....	145		
HomeLink Universal Transceiver.....	149		
Connecting to Wi-Fi.....	152		
Software Updates.....	153		
Mobile App.....	155		
Charging.....	158		
Electric Vehicle Components.....	158		
Battery Information.....	160		
Charging Instructions.....	162		

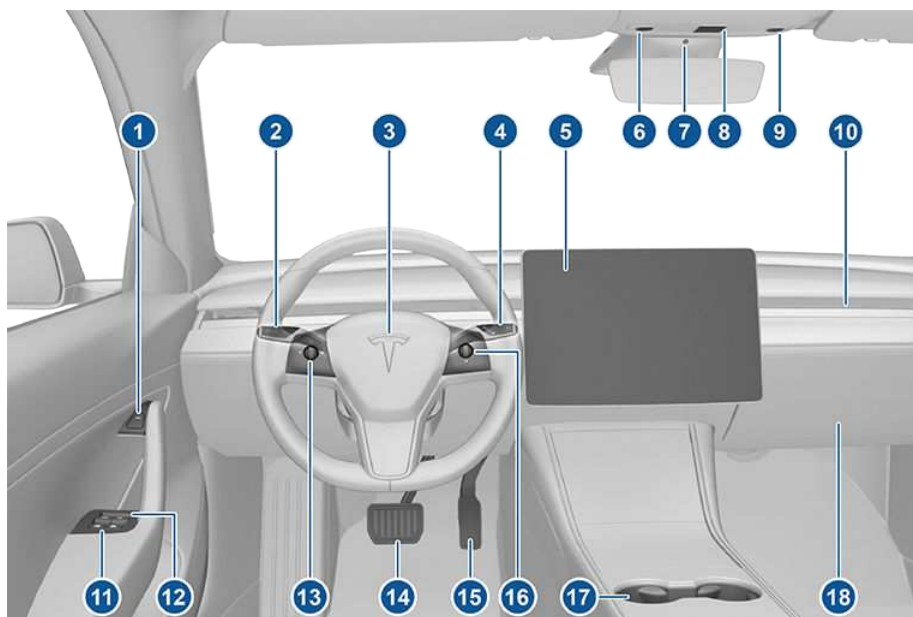

1. Door open button ([Opening Doors from the Interior](#) on page 14)
2. High beams ([High Beam Headlights](#) on page 61), turn signals ([Turn Signals](#) on page 62), and wipers and washers ([Wipers and Washers](#) on page 67)
3. Horn ([Horn](#) on page 53)
4. Gear selector ([Shifting Gears](#) on page 58), Traffic-Aware Cruise Control ([Traffic-Aware Cruise Control](#) on page 85), and Autosteer ([Autosteer](#) on page 91)
5. Touchscreen ([Touchscreen Overview](#) on page 4)
6. Driver dome light ([Lights](#) on page 60)
7. Cabin camera ([Cabin Camera](#) on page 27)
8. Hazard warning flashers ([Hazard Warning Flashers](#) on page 62)
9. Passenger dome light ([Lights](#) on page 60)
10. Climate control vent (see [Climate Controls](#) on page 127)
11. Power window switches ([Windows](#) on page 17)
12. Manual door release ([Opening Doors from the Interior](#) on page 14)
13. Left scroll button ([Scroll Buttons](#) on page 52)
14. Brake pedal ([Braking and Stopping](#) on page 68)
15. Accelerator pedal ([Regenerative Braking](#) on page 69)
16. Right scroll button ([Scroll Buttons](#) on page 52)
17. Center console ([Interior Storage and Electronics](#) on page 23)
18. Glovebox ([Glovebox](#) on page 23)

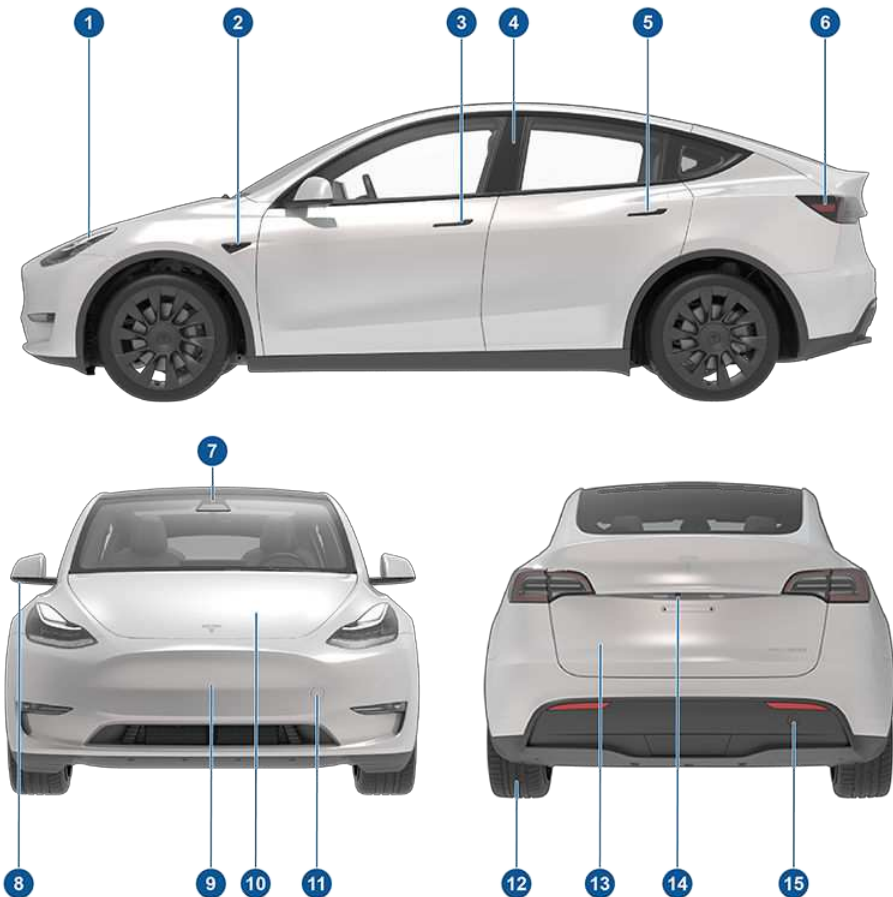

1. Exterior lights ([Lights](#) on page 60)
2. Autopilot camera ([About Autopilot](#) on page 82)
3. Front door handle ([Using Exterior Door Handles](#) on page 14)
4. Key card sensor ([Keys](#) on page 9), Autopilot camera ([About Autopilot](#) on page 82)
5. Rear door handle ([Using Exterior Door Handles](#) on page 14)
6. Charge port ([Charging Instructions](#) on page 162)
7. Autopilot cameras ([About Autopilot](#) on page 82)
8. Exterior mirrors ([Mirrors](#) on page 54)
9. Radar sensor (hidden from view) ([About Autopilot](#) on page 82)
10. Hood/front trunk ([Front Trunk](#) on page 20)
11. Front tow eye cover ([Instructions for Transporters](#) on page 203)
12. Wheels and tires ([Wheels and Tires](#) on page 194)
13. Rear trunk ([Rear Trunk](#) on page 18)
14. Rear view camera ([Rear View Camera](#) on page 77)
15. Rear tow eye cover ([Instructions for Transporters](#) on page 203)



# Touchscreen Overview

The features and information you need to drive Model Y are displayed on the touchscreen. When driving, the touchscreen displays driving-related information such as driving speed, vehicle range, warnings, etc. The touchscreen is used to control many features that, in traditional cars, are controlled using physical buttons (for example, adjusting mirrors). You can also use the touchscreen to customize Model Y to suit your preferences.

**Warning:** Always pay attention to road and traffic conditions when driving. To minimize driver distraction and ensure the safety of vehicle occupants as well as other road users, avoid using the touchscreen to adjust settings while the vehicle is in motion.

**Note:** The image below is provided for demonstration purposes only. Depending on vehicle options, software version and market region, your touchscreen may appear slightly different.

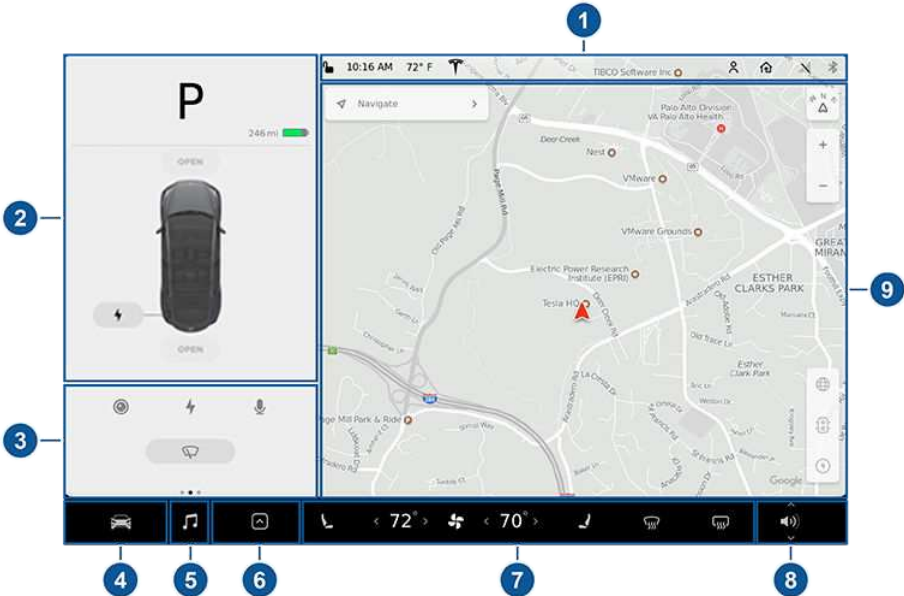

1. This area on the top of the touchscreen displays useful information and provides shortcuts to various features. In addition to the time of day and the current outside temperature, this area displays the following icons:



Touch to lock/unlock all doors and trunks.



Access information about your Model Y. See [The Tesla "T"](#) on page 8.



Add, configure, or quickly switch driver profiles (including Valet Mode and Easy Entry). See [Driver Profiles](#) on page 50.



Displays when a warning notification is in effect. Touch to display information about the warning.



Displays when a software update is available (see [Software Updates](#) on page 153).



Displays when dashcam is ready to be used (you have inserted a supported flash drive into a front USB port). Touch to operate dashcam (see [Dashcam](#) on page 78).



Touch to enable or disable Sentry Mode to actively monitor the vehicle's surroundings (see [Sentry Mode](#) on page 145).



Control or program HomeLink devices (if equipped) (see [HomeLink Universal Transceiver](#) on page 149).



Connected to a Wi-Fi network.



Connected to cellular network. Touch to connect to Wi-Fi (see [Connecting to Wi-Fi](#) on page 152).



Connect to a Bluetooth device (see [Pairing a Bluetooth Phone](#) on page 141).



Displays the status of the front passenger airbag (applicable only in regions where the airbag can be disabled, as described in [Airbags](#) on page 43).



2. **Car Status.** This area dynamically displays the current status of Model Y as you drive, park, open doors, turn lights on, etc. Monitor this area when driving as it displays important information such as driving speed and warning messages (see [Car Status](#) on page 64). When the car is in Park, you can open the trunks or charge port door.
3. **Cards.** This area automatically updates to display information such as incoming calls, seat belt reminders, current state of the wipers, etc. It also provides easy access to the rear view camera (see [Rear View Camera](#) on page 77), charging status (see [Charging Instructions](#) on page 162), voice commands (see [Using Voice Commands](#) on page 144), wiper controls (see [Wipers](#) on page 67), and seat belt reminders (see [Seat Belt Reminders](#) on page 32). Swipe to the right or left to access:
  - **Trips.** You can display distance driven, energy usage and energy efficiency starting at any time, or since Model Y was last charged. You can also display this information for up to two trips. Touch ... in the top right corner of a trip to rename or reset a trip.
  - **Tire Pressures.** Display tire pressures or view cautions or warnings related to pressures that are not within acceptable limits (see [Tire Care and Maintenance](#) on page 170).
4. **Controls.** Touch to control features and customize Model Y to suit your preferences (see [Controls](#) on page 118).
5. **Media Player** (see [Media and Audio](#) on page 138).



6. Touch the app launcher then choose from the following apps:



**Call.** See [Phone](#) on page 141.



**Calendar.** See [Calendar](#) on page 143.



**Camera.** Display the area behind Model Y. This area also displays automatically whenever you shift into Reverse. See [Rear View Camera](#) on page 77.



**Energy.** See [Getting Maximum Range](#) on page 76.



**Charging.** See [Charging Instructions](#) on page 162.



**Web.** Access the Internet using the web browser (if equipped with premium connectivity).



**Entertainment.** Browse the full library of games and access video streaming services, all from your vehicle's touchscreen. To launch, Model Y must be in Park.

**Note:** Due to vehicle configuration or market region, Entertainment, Arcade, and/or Theater may not be available on your vehicle.



**Toybox.** Shortcut to Easter Eggs. See [Easter Eggs](#) on page 207.

---

**Note:** Swiping up on the app launcher displays the most recently used app (provided an app is not currently being displayed).

**Note:** Depending on the market region and vehicle options, your vehicle may not be equipped with some features.

7. Climate Controls (see [Climate Controls](#) on page 127).
8. Volume Control (see [Volume Control](#) on page 138).





9. The map displays on the touchscreen at all times (see [Maps and Navigation](#) on page 132).

**Note:** When you touch **Controls**, choose an app, or expand Media Player, the window displays on top of the map. To close the Controls window, touch **Controls** again or touch the **X** in the top corner of the window. To close an app, touch the **X** in the top corner of the window. To close Media Player, drag it all the way down to the bottom of the touchscreen or touch the icon again.

## The Tesla "T"

Touch the Tesla "T" at the top center of the touchscreen to display:

- Vehicle name (see [Naming Your Vehicle](#) on page 125).\*
- Vehicle configuration.\*
- Odometer.\*
- Vehicle Identification Number (VIN).\*
- Version of software currently installed on your Model Y.
- Access to release notes associated with the currently-installed software version.\*
- Access to this owner's manual.
- One-touch access to call Tesla Customer Support and Roadside Assistance (if available in your market region).
- One-touch access to all discovered Easter Eggs (see [Easter Eggs](#) on page 207).

\*You can also display this information by touching **Controls** > **Software**.



## Three Types of Keys

Model Y supports three types of keys:

- **Authenticated phone** - You can set up your personal smartphone to communicate with Model Y using Bluetooth. Supports automatic locking and unlocking as well as several other functions using the Tesla mobile app.
- **Key card** - Tesla provides a key card that communicates with Model Y using short range radio-frequency identification (RFID) signals. The key card is used to "authenticate" your phone to work with Model Y and to add or remove other key cards, phones, or key fobs. In situations where your authenticated phone has a dead battery, or is lost or stolen, use your key card to unlock, drive, and lock Model Y.
- **Key fob** - The key fob allows you to press buttons to open the front and rear trunks, and unlock, lock, and drive Model Y. The key fob also supports automatic locking and unlocking, if available in your region (see [Passive Key Fob](#) on page 11). This is an accessory sold separately.

Model Y supports a total of 19 keys, which can include authenticated phones, key cards, and up to four key fobs.

- ⚠ Caution:** Remember to bring a key with you when you drive. Although you can drive Model Y away from its key, you will be unable to power it back on after it powers off.

## Authenticated Phone

Using your phone is a convenient way to access your Model Y. As you approach, your phone's Bluetooth signal is detected and doors unlock when you press a door handle. Likewise, when you exit and walk away with the phone, doors automatically lock (provided the **Walk-Away Door Lock** feature is turned on, as described in [Walk-Away Door Lock](#) on page 15).

Before you can use a phone to access Model Y, follow these steps to authenticate it:

1. Download the Tesla mobile app to your phone.

2. Log into the Tesla mobile app using your Tesla Account user name and password.

**Note:** You must remain logged in to your Tesla Account to use your phone to access Model Y.

3. Ensure that your phone's Bluetooth settings are turned on.

You must have your phone's Bluetooth setting turned on AND you must also ensure that Bluetooth is turned on within your phone's global settings for the Tesla mobile app. For example, on your phone, navigate to Settings, choose the Tesla mobile app, and ensure the Bluetooth setting is enabled.

**Note:** Model Y communicates with your phone using Bluetooth. To authenticate your phone or use it as a key, the phone must be powered on and Bluetooth must be enabled. Keep in mind that your phone must have enough battery power to run Bluetooth and that many phones disable Bluetooth when the battery is low.

4. Ensure that Allow Mobile Access (**Controls > Safety & Security > Allow Mobile Access**) is enabled.
5. In the Tesla mobile app, touch **PHONE KEY** then touch **START** to search for your Model Y.

When your Model Y is detected, the mobile app asks you to tap your key card.

6. Tap the key card against the Model Y card reader on the door pillar or center console (see [Key Card](#) on page 10).

When Model Y detects your key card, the mobile app confirms that your phone has been successfully authenticated. Touch **DONE**.

If the key card is not successfully scanned within approximately 30 seconds, the mobile app displays an error message. Touch **PHONE KEY** on the app again to retry.

To view a list of keys that can currently access Model Y, or to remove a phone, touch **Controls > Locks** (see [Managing Keys](#) on page 12).

**Note:** Authenticating your phone allows you to use it as a key to access Model Y. To use the phone hands-free, access your phone's contacts, play media from it, etc., you must also pair and connect to it using the Bluetooth settings (see [Phone](#) on page 141).

**Note:** Model Y can connect to three phones simultaneously. Therefore, if more than one phone is detected and you want to use, or



authenticate, a different phone, move the other connected phone(s) out of range or turn off its Bluetooth setting.

**Note:** Unlike the mobile app, once a phone has been authenticated, it no longer requires an internet connection to communicate with Model Y. Authenticated phones communicate with Model Y using Bluetooth.

**Note:** Although Bluetooth typically communicates over distances of up to approximately 30 feet (9 meters), performance can vary based on the phone you are using, environmental interference, etc.

**Note:** If multiple vehicles are linked to the Tesla Account, you must switch the mobile app to the vehicle that you want to access before you can use the phone as a key.

## Key Card

Tesla provides you with two Model Y key cards, designed to fit in your wallet. Tap your Model Y key card on one of its card readers, located on the driver's side door pillar and on the center console.

To use a key card to unlock or lock Model Y, position the card as shown and tap it against the card reader located approximately one third the way up of the driver's side door pillar. When Model Y detects the key card, the exterior lights flash, the mirrors unfold or fold (if Fold Mirrors is on), the horn sounds (if Lock Sound Confirmation is on), and the doors unlock or lock.

**Note:** You may need to physically touch the center console or driver's side door pillar with the key card, and you may need to hold it against the transmitter for one or two seconds.



Once inside, power up Model Y by pressing the brake pedal within thirty seconds of scanning the key card (see [Starting and Powering Off](#) on page 56). If you wait longer than thirty seconds, you must re-authenticate by placing the key card near the card reader located behind the cup holders on the center console. When your key card is detected, your 30 second authentication period restarts.

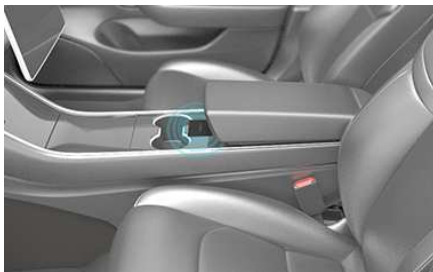

**Note:** Walk-Away Door Lock operates only when using an authenticated phone or passive key fob. When you walk away from Model Y carrying your key card, Model Y does not automatically unlock/lock, even if this feature is turned on (see [Walk-Away Door Lock](#) on page 15).

**⚠ Caution:** Always carry your key card with you in your purse or wallet to use as a backup in case your authenticated phone has a dead battery, or is lost or stolen.

## Key fob

If you have purchased the key fob accessory (available for purchase from Tesla stores or online at <http://www.tesla.com/shop>), you can quickly familiarize yourself with this key by thinking of it as a miniature version of Model Y, with the Tesla badge representing the front. The key has three buttons that feel like softer areas on the surface.



1. Front trunk - Double-click to open the front trunk.
2. Lock/Unlock All - Single-click to lock doors and trunks (all doors and trunks must be closed). Double-click to unlock doors and trunks.
3. Rear trunk - Double-click to open the rear trunk. Hold down for one to two seconds to open the charge port door.

Once inside, power up Model Y by pressing the brake pedal within two minutes of pressing the unlock button on the key fob (see [Starting and Powering Off](#) on page 56). If you wait longer than two minutes, you must press the unlock button again, or place the key fob near the card reader located behind the cup holders on the center console. When your key fob is detected, the two minute authentication period restarts.

When approaching or leaving Model Y carrying the key fob, you do not need to point the key fob at Model Y as you press a button, but you must be within operating range.

Radio equipment on a similar frequency can affect the key. If this happens, move the key at least one foot (30 cm) away from other electronic devices (phone, laptop, etc.).

If the key fob does not work (for example, its battery is dead), you can touch its flat side against the card reader on the driver's side door pillar (like the key card). Instructions for changing the battery are provided in [Replacing the Key Fob Battery](#) on page 12.

**Note:** You can use the same key fob with multiple Model Y vehicles provided you authenticate it (see [Managing Keys](#) on page 12). However, key fob works with only one Model Y at a time. Therefore, to use a key fob for a different Model Y, touch its flat side

against the card reader on the driver's side door pillar.

**Note:** Model Y supports up to four different key fobs.

**⚠ Caution:** Protect the key from impact, high temperatures, and damage from liquids. Avoid contact with solvents, waxes and abrasive cleaners.

### Passive Key Fob

Due market region or vehicle configuration, Passive Key Fob may not be available for your vehicle.

Locking and unlocking Model Y with your key fob is conveniently hands-free. Although you must be carrying a paired key fob, there is no need to use it. Model Y has sensors around the vehicle that can recognize the presence of a key fob within a range of approximately three feet (one meter). Therefore, you can keep your key fob in your pocket or purse and simply pull on the door handle to unlock. When carrying your key fob with you, you can also open the trunk without having to use the key by pressing the trunk's exterior door handle. If Walk-Away Lock is on, your vehicle automatically locks when you exit and senses that the key fob is no longer in range (see [Walk-Away Door Lock](#) on page 15). Passive key fob is automatically enabled when you pair your key fob to your vehicle.

The key fob can only be paired to one vehicle at a time. If you want your key fob to passively lock and unlock for a different vehicle, touch the flat side of the key fob onto the driver's side door pillar or center console card reader. You only need to do this once to pair it to your desired vehicle. You must pair your key fob every time you use it with a different vehicle.

**Note:** Only key fobs with the TESLA logo printed on the flat side have the passive locking and unlocking functionality.

**Note:** For increased security, your key fob disables itself after five minutes of being stationary while in range but the vehicle is not in use. The vehicle will not lock or unlock passively when this occurs. Shake or press a button on your key fob to wake it up.



## Replacing the Key Fob Battery

Under normal use, the accessory key fob (available at <https://shop.tesla.com>) has a battery that lasts for up to five years, depending on key fob version and selected vehicle settings. When the battery is low, a message displays on the touchscreen.

To replace the key fob battery:

1. With the key fob placed button side down on a soft surface, release the bottom cover.



2. Remove the battery by lifting it away from the retaining clips.



3. While avoiding touching the battery's flat surfaces, insert the new battery (type CR2032) with the '+' side facing up.

**Note:** CR2032 batteries can be purchased through online retailers, local supermarkets, and drug stores.

4. Holding the bottom cover at an angle, align the tabs on the cover with the corresponding slots on the key fob, then press the cover firmly onto the key fob until it snaps into place.
5. Test that the key fob works by unlocking and locking your vehicle.

## Attaching a Lanyard

To attach a lanyard, release the bottom cover as described above. Place the lanyard over the pin located between the slots on the widest side of the key fob. Re-align the cover and snap into place.

## Managing Keys

To display a list of all keys (phones, key cards, and key fobs) that can access your Model Y, touch **Controls** > **Locks**. An icon displays next to each key to indicate whether the key is a phone, key card, or key fob. Use this list to manage keys that have access to your vehicle. To add or delete keys, see [Adding and Removing Keys](#) on page 12.

**Note:** You can use the same key for more than one Model Y. This prevents you from having to deal with multiple keys when you switch vehicles. If you customize the name of an authenticated key card or key fob on one Model Y (by touching the pencil icon), any other Model Y to which the key card or key fob is authenticated also displays the same customized name.

**Note:** Model Y supports up to 19 keys. When you reach this limit, you must delete a key before adding a new one.

## Adding and Removing Keys

Adding a new key card or key fob:

**Note:** If adding a key fob, ensure the key fob is at room temperature. Pairing may be unsuccessful if the key fob is cold.

1. On the touchscreen, touch **Controls** > **Locks** then touch + in the Keys section.
2. Scan your new key card or key fob on the key reader behind the cup holders on the top of the center console. After the new key card or key fob is recognized, remove it from the key reader.
3. Scan an already-authenticated (i.e. already has access to the vehicle) key card or key fob on the key reader behind the cup holders on the top of the center console.
4. When complete, the key list on the touchscreen displays the newly-authenticated key. You can customize its name by touching the associated pencil icon.

Adding a new phone key:

**Note:** To add a new phone key, Bluetooth must be enabled and the phone must have the Tesla



mobile app installed and connected to the vehicle's Tesla account.

1. While sitting in the vehicle, open the Tesla mobile app and select the appropriate vehicle (if there are multiple vehicles associated with the account), then touch **Phone Key > Start**.
2. Scan an already-authenticated key card or key fob on the key reader behind the cup holders on the top of the center console.
3. When the mobile app notifies you that the pairing was successful, touch **Done**. The key list on the touchscreen (**Controls > Locks**) displays the new phone key. The name of the phone key is determined by the name used in the phone's settings.

Removing a key:

When you no longer want a key to access your vehicle (for example, you lost your phone or key card, etc.), you can remove the key.

1. On the touchscreen, touch **Controls > Locks**.
2. Find the key that you would like to delete in the key list, then touch the key's associated trash icon.
3. When prompted, scan an already-authenticated key card or key fob on the key reader behind the cup holders on the top of the center console to confirm the deletion. When complete, the key list no longer includes the deleted key.

**Note:** Your vehicle requires at least one authenticated key card or key fob at all times. If only one key card is included on the key list, this key cannot be deleted.



## Keyless Locking and Unlocking

Locking and unlocking Model Y is easy and convenient. Just carry your authenticated phone or paired key fob with you. Model Y recognizes the presence of an authenticated phone or paired key fob and automatically unlocks when you press a door handle, and locks when you leave (see [Walk-Away Door Lock](#) on page 15).

**Note:** If you don't have your authenticated phone or paired key fob with you (or if the phone's battery is dead or its Bluetooth setting is turned off), place the key card against the driver's side door pillar to manually unlock or lock Model Y (see [Keys](#) on page 9).

**Note:** Due to market region or vehicle configuration, an authenticated phone or Passive Key Fob may not be available for your vehicle.

**Note:** Your key fob (<https://shop.tesla.com>) also allows you to press buttons to lock and unlock Model Y.

**Note:** Walk-Away Door Lock operates only when using an authenticated phone or paired key fob. When you walk away from Model Y carrying a key card or unpaired key fob accessory, Model Y does not automatically unlock/lock, even if this feature is turned on (see [Walk-Away Door Lock](#) on page 15).

**Note:** Accessory key fobs manufactured before approximately October, 2019 are not equipped with passive functionality.

## Using Exterior Door Handles

Use your thumb to push the wide part of the door handle. The handle pivots toward you, and you can open the door by pulling the handle or pulling the edge of the door.



The handle retracts automatically.



When a door or trunk is open, the touchscreen displays the Door Open indicator light.

**Note:** See [Cold Weather Best Practices](#) on page 80 to ensure the vehicle's door handles function properly in cold weather.

## Opening Doors from the Interior

Model Y doors are electrically powered. To open a door while sitting inside, press the button located at the top of the interior door handle and push the door open.

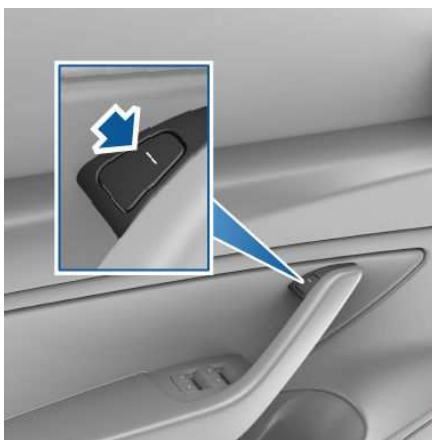

**Note:** To prevent children from opening the rear doors, turn on child-protection locks (see [Child-Protection Lock](#) on page 16).



In the unlikely situation that Model Y has no power, these electrically powered buttons at the top of the door handles no longer work. However, the doors are equipped with mechanical releases so that you can still open them.

To open a front door when Model Y has no power, pull up the manual door release located in front of the window switches.



To open a rear door when Model Y has no power:

1. Remove the mat from the map pocket in the door panel.
2. Use your fingernail or a small flat-bladed tool to open the plastic flap.



3. Pull the mechanical release cable (foam block) to release the door latch.



- ⚠ Caution:** Manual door releases are designed to be used only in situations when Model Y has no power. Whenever Model Y has power, use the button located at the top of the interior door handle.

## Interior Locking and Unlocking

While sitting inside Model Y, you can lock and unlock all doors and trunks by touching the lock icon on the touchscreen.



The icon changes to indicate whether doors are locked or unlocked.

You can also unlock the doors by pressing the Park button on the end of the gear selector a second time. Pressing this button once engages the Park gear and pressing it again unlocks the doors.

## Walk-Away Door Lock

Doors and trunks can automatically lock whenever you walk away carrying your authenticated phone or paired key fob (if ordered after approximately October 1, 2019). To turn this feature on or off, touch **Controls > Locks > Walk-Away Door Lock**.

When the doors lock, the exterior lights flash once and the mirrors fold (if Fold Mirrors is on). To also hear a confirmation sound whenever Model Y locks, touch **Controls > Locks > Lock Confirmation Sound > ON**.

Model Y does not automatically lock if:

- An authenticated phone or paired key fob is detected inside Model Y.





- You are not using an authenticated phone or paired key fob as the key, and walk away carrying the key card or unpaired key fob (see [Passive Key Fob](#) on page 11). When using the key card you must manually lock Model Y by tapping the key card against the door pillar. When using an unpaired key fob (sold as an accessory), you must manually lock Model Y by pressing the lock button. See [Keys](#) on page 9.
- A door or trunk is not fully closed.

**Note:** If all doors are closed and Model Y was automatically unlocked by your authenticated phone or paired key fob, walk-away locking is temporarily suspended for one minute. If you open a door within this minute, it will not re-lock until all the doors are closed and you have walked away with the authenticated phone or paired key fob.

**Note:** If Model Y detects an authenticated key for five minutes after you exit the vehicle and close all doors, Walk-Away Lock disables and will not lock when you leave with the key. You will need to manually lock your vehicle until after your next drive.

## Drive Away Locking

Model Y automatically locks all doors (including the trunks) whenever your driving speed exceeds 5 mph (8 km/h).

## Child-Protection Lock

Model Y has child-protection locks on the rear doors to prevent them from being opened using the interior release buttons. On the touchscreen, touch **Controls** > **Locks** > **Child Lock**.

**Note:** It is recommended that you turn child-protection locks on whenever children are seated in the rear seats.

## Unlock on Park

When you stop Model Y and engage the Park gear, you can choose to unlock all doors. To turn this feature on or off, touch **Controls** > **Locks** > **Unlock on Park**.

**Note:** If set to **OFF**, you can unlock all doors by pressing the Park button a second time after engaging the Park gear.



## Opening and Closing

Press down on a switch to lower the associated window. Window switches operate at two levels:

- To lower a window fully, press the switch all the way down and immediately release.
- To lower a window partially, press the switch gently and release when the window is where you want it.

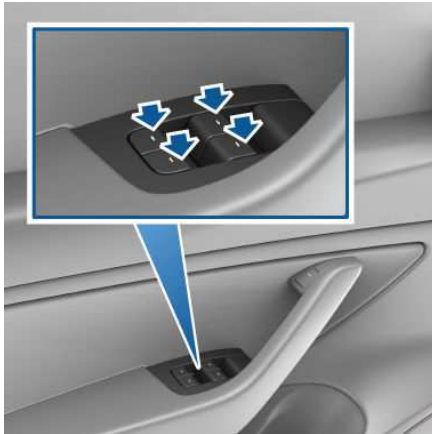

Similarly, pull a switch to raise the associated window:

- To raise a window fully, pull the switch all the way up and immediately release.
- To raise a window partially, pull the switch gently and release when the window is where you want it.

**Note:** See [Cold Weather Best Practices](#) on page 80 for information on preparing windows for cold weather.

- ⚠ **Caution:** When exiting the vehicle, be careful not to unintentionally press the window switches, as they may lower the windows on the driver or other doors.
- ⚠ **Caution:** Closing the door while the window is fully raised (for example, if manually raised) can damage the windows or the vehicle. Ensure the window is slightly lowered before closing the door.
- ⚠ **Warning:** Before closing a window, it is the driver's responsibility to ensure that all occupants, especially children, do not have any body parts extended through the window's opening. Failure to do so can cause serious injury.

## Locking Rear Windows

To prevent passengers from using the rear window switches, touch **Controls > Quick Controls > Window Lock**. To unlock the rear windows, touch **Window Lock** again.

- ⚠ **Warning:** To ensure safety, it is recommended that you lock the rear window switches whenever children are seated in the rear seats.
- ⚠ **Warning:** Never leave children unattended in Model Y.

## Calibrating Windows

In the unlikely event that a window behaves unexpectedly (touches the bright molding, fails to open or close properly, goes down more than normal when the door opens, etc.), you can calibrate it to potentially fix the issue.

To calibrate a window:

1. Close the door with the affected window.
2. Sit in the driver's seat and close the driver door.
3. Use the driver window switch to **raise** the affected window until it stalls.
4. Use the driver window switch to **lower** the affected window until it stalls.
5. Use the driver window switch to **raise** the affected window until it stalls.

The window should now be calibrated. If the issue continues after attempting the calibration procedure a couple times, contact Tesla.



## Opening

To open the rear trunk, ensure the vehicle is in Park then do one of the following:

- Touch the associated **OPEN** button on the touchscreen.
- Double-click the rear trunk button on the key fob accessory.
- Touch the trunk button on the mobile app.
- With Model Y unlocked, press the switch located under the rear trunk's exterior handle.



When a door or trunk/liftgate is open, the touchscreen displays the Door Open indicator light. The image of your Model Y on the touchscreen also displays the open trunk.

To stop a powered liftgate while it is moving, single-click the rear trunk button on the key fob. Then, when you double-click the rear trunk button, it moves again, but in the opposite direction (provided it was not almost entirely open or closed when you stopped it). For example, if you single-click to stop the liftgate while it is opening, when you double-click, it closes.

**Note:** In emergency situations, you can override an Open or Close command by grabbing hold of the lift gate to stop it in place.

**Warning:** Before opening or closing the liftgate, it is important to check that the area around the liftgate is free of obstacles (people and objects). Although the powered liftgate can detect obstacles,

it cannot detect all objects at all times. Do not rely on the liftgate to sense an obstruction when opening or closing. You must proactively monitor the liftgate to ensure that it does not come into contact with a person or object. Failure to do so may result in damage or serious injury.

## Load Limits

Secure all cargo before moving Model Y, and place heavy cargo in the lower trunk compartment.

**Caution:** To avoid damage, never load more than 130 lbs (60 kg) on the rear load floor (above the lower trunk compartment) or more than 285 lbs (130 kg) in the lower trunk compartment. Doing so can cause damage.

## Closing

To close the powered liftgate, do one of the following:

- Touch the associated **CLOSE** button on the touchscreen.
- Double-click the trunk button on the key fob.
- Press the switch located on the underside of the liftgate (see [Adjusting Liftgate Opening Height](#) on page 18).

If a powered liftgate senses an obstruction when closing, it automatically opens and sounds five chimes. Remove the obstruction and try closing it again. If it cannot close the second time, powered operation is temporarily disabled. Close it manually to restore powered operation.

**Note:** The power closing feature is also temporarily disabled if you leave the powered liftgate open for more than an hour.

## Adjusting Liftgate Opening Height

You can adjust the opening height of the powered liftgate to make it easier to reach or to avoid low-hanging ceilings or objects (for example, a garage door or light):

1. Open the liftgate, then manually lower or raise it to the desired opening height.



2. Press and hold the button on the underside of the liftgate for two seconds until you hear a confirmation chime.



3. Confirm that you have set it to the desired height by closing the liftgate, then reopening it.

### Accessing the Cargo Area

To access the cargo area inside the rear trunk, pull up the strap at the rear of the cargo cover. You can then fold the cargo cover forward or remove it from Model Y.



- ⚠ Caution:** Never load more than 130 lbs (60 kg) on the rear load floor (above the lower trunk compartment) or more than 285 lbs (130 kg) in the lower trunk compartment. Doing so can cause damage.



## Opening

To open the front trunk:

1. Ensure that the area around the hood is free of obstacles.
2. Touch the associated **OPEN** button on the touchscreen, double-click the front trunk button on the key fob accessory, or touch the front trunk button on the mobile app.
3. Pull the hood up.



When a door or trunk/liftgate is open, the touchscreen displays the Door Open indicator light. The image of your Model Y on the touchscreen also displays the open front trunk.

**Warning:** Before opening or closing the hood, it is important to check that the area around the hood is free of obstacles (people and objects). Failure to do so may result in damage or serious injury.

**Note:** The front trunk locks whenever closed and you lock Model Y using the touchscreen, mobile app, key card, you leave Model Y carrying your authenticated phone (if Walk-Away Door Lock is turned on), or if Valet mode is active (see [Valet Mode](#) on page 51).

## Closing

The Model Y hood is not heavy enough to latch under its own weight and applying pressure on the front edge or center of the hood can cause damage.

To properly close the hood:

1. Lower the hood until the striker touches the latches.
2. Place both hands on the front of the hood in the areas shown (in green), then press down firmly to engage the latches.

3. Carefully try to lift the front edge of the hood to ensure that it is fully closed.



**Caution:** To prevent damage:

- Apply pressure only to the green areas shown. Applying pressure to the red areas can cause damage.
- Do not close the hood with one hand. Doing so applies concentrated force in one area and can result in a dent or crease.
- Do not apply pressure to the front edge of the hood. Doing so can create the edge.
- Do not slam or drop the hood.

**Warning:** Before driving, you must ensure that the hood is securely latched in the fully closed position by carefully trying to lift the front edge of the hood upward and confirming there is no movement. If the front trunk is not closed, a message displays on the touchscreen that you cannot shift the vehicle out of Park until the front trunk is securely closed (see [Park](#) on page 58).

## Interior Emergency Release

An illuminated interior release button inside the front trunk allows a person locked inside to get out.



Press the interior release button to open the front trunk, then push up on the hood.

**Note:** The interior release button glows following a brief exposure to ambient light.

- ⚠ Warning:** People should never climb inside the front trunk. Never shut the front trunk when a person is inside.
- ⚠ Warning:** Care should be taken to ensure that objects inside the front trunk do not bump against the release button, causing the trunk to accidentally open.

## Opening Hood with No Power

In the unlikely event that Model Y has no 12V power, you will be unable to open the front trunk using the touchscreen, key fob, or mobile app. To open the front trunk in this situation:

**Note:** The following will not open the front trunk if Model Y is locked and has 12V power.

1. Locate an external 12V power supply (such as a portable jump starter).
2. Release the tow eye cover by pressing firmly on the top right perimeter of the cover until it pivots inward, then gently pulling the raised section toward you.

**Note:** Depending on production date, either the positive or negative terminal may be attached to the tow eye cover.



3. Pull the two wires out of the tow eye opening to expose both terminals.



4. Connect the 12V power supply's red positive (+) cable to the red positive (+) terminal.
5. Connect the 12V power supply's black negative (-) cable to the black negative (-) terminal.



**Note:** Applying external 12V power to these terminals only releases the hood latches. You cannot charge the 12V battery using these terminals.

6. Turn on the external power supply (refer to the manufacturer's instructions). The hood latches are immediately released and you can now open the hood to access the front trunk area.
7. Disconnect both cables, beginning with the black negative (-) cable.



8. If pulling Model 3 onto a flatbed truck, do not replace the tow eye cover yet. Otherwise, replace the tow eye cover by inserting the wires into the tow eye opening and aligning the tow eye cover into position and turning it into place.





## Glovebox

To open the glovebox, touch **Controls** > **Glovebox** on the bottom corner of the touchscreen. The glovebox automatically opens and its light turns on.



To close the glovebox, push it upward until it clicks into its closed position.

**Note:** If you leave the glovebox open, its light eventually turns off.

**Note:** The glovebox locks whenever closed and you lock Model Y using the mobile app, key card, you leave Model Y carrying your authenticated phone (if Walk-Away Door Lock is turned on), or if Valet mode is active (see [Valet Mode](#) on page 51). It does not lock when Model Y is locked by touching the lock icon on the touchscreen.

**Warning:** When driving, keep the glovebox closed to prevent injury to a passenger if a collision or sudden stop occurs.

## Center Console

In addition to housing an RFID transmitter that reads key fobs and key cards (see [Key Card](#) on page 10), the center console includes cup holders, two storage compartments, and a phone dock for two phones (or other devices).



To open the main storage compartment, pull its cover upward.

Open the other storage compartment or access the phone dock by pressing firmly near the cover's opening edge. To close a storage compartment, push its cover down gently.

## USB Ports

Model Y has two USB 2.0 ports located in the front compartment of the center console. The left USB port is USB-C compatible. These ports can be used to connect and charge your phone (see [Installing Phone Charging Cable](#) on page 24), save videos when using features such as Sentry Mode or Dashcam, or play audio files stored on a phone or USB device (see [Playing Media from Devices](#) on page 139).

Open the center console door below the touchscreen and lift the phone dock upward to access the front USB ports.



Two additional USB-C ports are located in the rear of the center console. Passengers in the rear seats can use these ports to charge their USB-connected devices. Devices connected to the rear USB ports do not communicate with the vehicle.





**Note:** Power is available whenever the vehicle is considered “awake”. The vehicle may be awake for many reasons. For example, when using features such as Summon, or when features such as Cabin Overheat Protection, Keep Climate On, Dog Mode, Sentry Mode, etc. are enabled. The vehicle is also awake whenever the 12V battery is being charged or is in use, during HV charging, when the vehicle is communicating with the mobile app, etc. Leaving an accessory plugged in does not deplete the 12V battery.

**Note:** Always use USB 2.0 compliant cables when connecting devices to the USB ports. Using non-compliant cables can result in slower charging and, if plugged into either of the front two ports, can result in potential connection problems or degraded performance when trying to access media files on the device.

**Note:** Do not connect multiple devices using a USB hub. This can prevent connected devices from charging or from being recognized by Media Player, Sentry Mode, Dashcam, etc.

## Installing Phone Charging Cable

To make it easy to connect your phone while keeping the console free of clutter, you can install a phone charging cable in Model Y.

**Note:** The phone dock supports two phones side-by-side.

To install a phone charging cable:

1. Open both center console doors in front of the cup holders.



2. Remove the rubber mat from the phone dock.
3. Lift the phone dock to access the USB ports.
4. Release the cover from the base of the phone dock by sliding it to the left.



5. Plug the USB connector on the phone charging cable into a USB port.
6. Insert the phone end of the charging cable through the bottom of the phone dock and route the cable through the securing tabs towards the bottom of the phone dock.





7. Reinstall the cover to the base of the phone dock by sliding it to the right.
8. Lower the phone dock and reinstall the rubber mat.

## Inductive Phone Charger

The inductive phone charger can charge your Qi-enabled smartphone at up to 15W of power. Ensure the charger cable is plugged into the driver's side USB-C port. Then, place your smartphone on the charging mat. The charging mat supports up to two phones at once, charging side by side. Charging two phones at once will take longer to charge because power must be divided between the devices. Your smartphone(s) may feel warm while charging, but this is a normal effect of inductive charging.



Model Y charges your smartphone only when the vehicle is powered on (i.e., the touchscreen is on, and you are in your vehicle). Your device will not continue to charge if you leave it plugged in after exiting the vehicle. Model Y will not charge your smartphone if the vehicle's Battery is discharged.

**Note:** Ensure your smartphone supports inductive charging.

**Note:** The inductive charger may not work if your phone case is made of metal. Take the phone out of the case and place the phone on the charger.

## 12V Power Socket

Your Model Y has a power socket located in the center console's rear compartment.

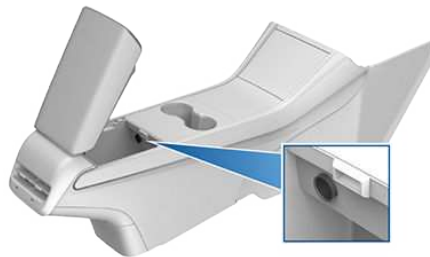

The power socket is suitable for accessories requiring up to 12A continuous draw (16A peak).

**Note:** Power is available whenever the vehicle is considered "awake". The vehicle may be awake for many reasons. For example, when using features such as Summon, or when features such as Cabin Overheat Protection, Keep Climate On, Dog Mode, Sentry Mode, etc. are enabled. The vehicle is also awake whenever the 12V battery is being charged or is in use, during HV charging, when the vehicle is communicating with the mobile app, etc. Leaving an accessory plugged in does not deplete the 12V battery.

- Warning:** The power socket and an accessory's connector can become hot.
- Warning:** To prevent excessive interference with the vehicle's electronics, Tesla recommends that you do not plug any non-Tesla accessories, including power inverters, into the 12V power socket. However, if you do use a non-Tesla accessory and notice any malfunctions or unexpected behavior, such as indicator lights, alert messages, or excessive heat from the accessory, unplug the accessory from the 12V power socket immediately.
- Caution:** Do not attempt to jump start Model Y using the 12V power socket. Doing so can result in damage.

## Rear Console

Your Model Y has a rear console integrated in the center of the second row seat back. Pull the console down to access the rear cup holders, or use it as an armrest.



## Coat Hangers

Your Model Y has a coat hanger on each side of the vehicle in the second row and a reading light next to each hanger (see [Reading Lights](#) on page 61). Push the coat hanger to release it. Push it again to retract it.

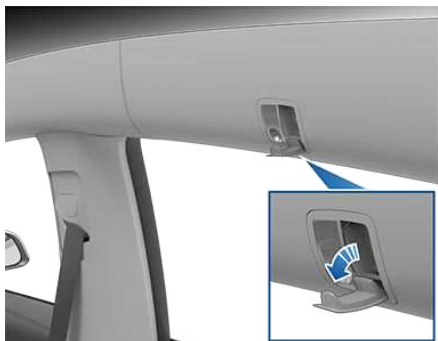



## Cabin Camera

Model Y is equipped with a camera in the cabin. The camera is not currently active, but might be used in potential future features which could be added to Model Y with software releases.



Keep the camera lens clean, and free of obstructions. Remove any buildup of dirt or dust by occasionally wiping the camera lens with a soft damp cloth.

**⚠ Caution:** Do not use chemical-based or abrasive cleaners. Doing so can damage the surface of the camera lens.



## Correct Driving Position

The seat, head support, seat belt and airbags work together to maximize your safety. Using these correctly ensures greater protection.



Position the seat so you can wear the seat belt correctly, while being as far away from the front airbag as possible:

1. Sit upright with both feet on the floor and the seat back reclined no more than 30 degrees.
2. Make sure you can easily reach the pedals and that your arms are slightly bent when holding the steering wheel. Your chest should be at least 10 inches (25 cm) from the center of the airbag cover.
3. Place the shoulder section of the seat belt mid-way between your neck and your shoulder. Fit the lap section of the belt tightly across your hips, not across your stomach.

Model Y seats include integrated head supports in the front that cannot be adjusted or removed.

## Adjusting the Front Seats

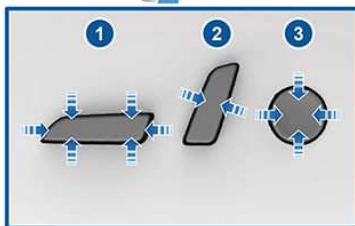

1. Move seat forward/backward and adjust the seat's height and tilt angle up/down.
2. Adjust backrest.
3. Adjust lumbar support.

**Warning:** Before adjusting a front seat, check that the area around the seat is free of obstacles (people and objects).

**Warning:** Do not adjust seats while driving. Doing so increases the risk of a collision.

**Warning:** Riding in a moving vehicle with the seat back reclined can result in serious injuries in a collision, as you could slide under the lap belt or be propelled into the seat belt. Ensure your seat back is reclined no more than 30 degrees when the vehicle is moving.



## Adjusting and Folding Second Row Seats

Model Y provides seating for up to three passengers in the second row. Use the adjustment handles on the outside corner of each outboard seating position to adjust the corresponding seat backs. The seat back is split 60/40 so the adjustment handle on the left side moves the seat backs for both the left and center seating positions, whereas the handle on the right side moves the rightmost seat back only. While pulling and holding the handle, move the seat back to the desired position, and then release the handle. Ensure the seat back is securely latched into position by pushing it forward and rearward.



To maximize cargo space, each second row seat back can be folded fully forward to lay flat. While pulling and holding the handle, push the corresponding seat back fully forward.

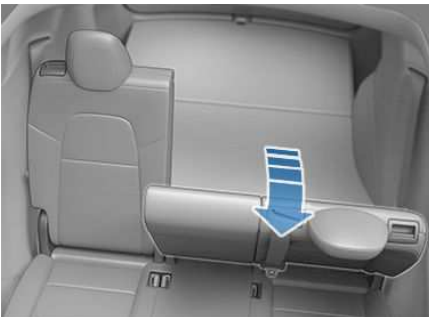

**Note:** Before folding seats fully forward, remove any items from the seats and the rear footwell. To allow the seat backs to fold completely flat, you may need to move the front seats forward.

**Note:** Driving with the rear seats folded forward may increase perceivable noise and/or vibration coming from the rear of the vehicle (trunk, suspension, etc.).

To allow you to carry long items (such as skis) in the rear of Model Y, the center seat back can also be independently folded forward. Pull the handle on the rear of the seat back. The seat back unlatches and can be pushed forward.



You can also fold the second row seat backs fully forward by pressing the corresponding switch located on the left side of the rear trunk area. Pressing the switch causes the seat back to swing forward. You can then push it downward so it lays fully flat.



## Raising Rear Seats

Before raising a rear seat, make sure that the seat belts are not trapped behind the backrest.

Pull the seat back upward until it locks into place.

To confirm that the seat back is locked in the upright position, try pulling it forward.

**Warning:** Always ensure the seat backs are locked in their upright position by pushing it forward or rearward. Failure to do so increases the risk of injury.

## Head Supports

The front seats include integrated head supports that are not adjustable.

The rear seats include an adjustable head support that can be raised, lowered, or removed. The head support should always be raised and locked into position (so that the center is aligned with the center of the ears) when occupied by a passenger that is not in a child safety seat.



**Warning:** The head support in the rear center seat must be lowered when a seat belt retained child safety seat is installed in that seating position. See [Raising/Lowering the Rear Center Head Support](#) on page 30.

**Warning:** Ensure that all head supports are positioned correctly before sitting in, or operating, Model Y to minimize the risk of severe injury or death in the event of a collision.

## Raising/Lowering the Outer Rear Seat Head Supports

To raise the head support, lift it until you hear it click into place. Push down on the head support to ensure that it is secure.

To lower the head support, press and hold the button on the outer base of the left post and press the head support down.

## Raising/Lowering the Rear Center Head Support

To raise the head support, lift it until you hear it click into place. Push down on the head support to ensure that it is secure.

To lower the head support, press and hold the button on the outer base of the right post and press the head support down.



## Removing/Installing a Head Support

To remove the head support:

1. Raise the head support as described above.
2. Press and hold the button on the outer base of the right post.



3. Insert a short, flat object (such as a small flat-head screwdriver) into the opening on the inside base of the left post and pull the head support upward.



To re-install the head support:

1. With the front of the head support facing forward, insert both posts into the corresponding holes on the seat back.
2. Press down on the head support until it clicks into place.
3. Pull up on the head support to ensure that it is secure.

**Warning:** Ensure that the head support is correctly installed before seating an occupant. Failure to do so increases the risk of injury or death if a collision occurs.

## Seat Heaters

The front and rear seats contain heating pads that operate at three levels from 3 (highest) to 1 (lowest). To operate the seat heaters, see [Climate Controls](#) on page 127.

**Warning:** To avoid burns resulting from prolonged use, individuals who have peripheral neuropathy, or whose capacity to feel pain is limited because of diabetes, age, neurological injury, or some other condition, should exercise caution when using the climate control system and seat heaters.

## Seat Covers

**Warning:** Do not use seat covers in Model Y. Doing so could restrict deployment of the seat-mounted side air bags if a collision occurs. Also, if the vehicle is equipped with an occupant detection system that is used to determine the status of the passenger front airbag, seat covers may interfere with this system.





## Wearing Seat Belts

Using seat belts and child safety seats is the most effective way to protect occupants if a collision occurs. Therefore, wearing a seat belt is required by law in most jurisdictions.

Both the driver and passenger seats are equipped with three-point inertia reel seat belts. Inertia reel belts are automatically tensioned to allow occupants to move comfortably during normal driving conditions. To securely hold child safety seats, all passenger seating positions are equipped with an automatic locking retractor (ALR) that, by pulling the seat belt beyond the length needed for a typical adult occupant, locks the belt into place until the seat belt is unbuckled.

The seat belt reel automatically locks to prevent movement of occupants if Model Y experiences a force associated with hard acceleration, braking, cornering, or an impact in a collision.

## Seat Belt Reminders



The seat belt reminder on the touchscreen alerts you if a seat belt for an occupied driver or passenger seat is unbuckled. If the belt remains unbuckled, the reminder flashes and an intermittent chime sounds. If all occupants are buckled up and the reminder stays on, re-buckle seat belts to ensure they are correctly latched. Also remove any heavy objects (such as a briefcase) from an unoccupied seat. If the reminder light continues to stay on, contact Tesla.

You can temporarily mute a seat belt reminder associated with a rear seating position. This is useful in situations when you are carrying an object in a rear seat that triggers the seat belt reminder alert. To mute the reminder, touch the associated seat on the seat belt reminder card that displays on the touchscreen when a seat belt reminder alert is active. When a reminder is muted, the seat belt reminder icon is replaced by a seat icon. Touch the seat again to unmute the reminder. The reminder is disabled for the current drive only.

**Warning:** Seat belts must be worn by passengers in all seating positions. Do not disable a seat belt reminder when the seating position is occupied by a passenger.

## To Fasten a Belt

1. Ensure correct positioning of the seat (see [Correct Driving Position](#) on page 28).
2. Draw the belt out smoothly, ensuring the belt lays flat across the pelvis, chest and mid-point of your collar bone, between the neck and shoulder.
3. Insert the latch plate into the buckle and press together until you hear a click indicating it is locked in place.



4. Pull the belt to check that it is securely fastened.
5. Pull the diagonal part of the belt toward the reel to remove excess slack.

## To Adjust the Shoulder Anchor Height

Model Y is equipped with an adjustable shoulder anchor for each front seat to ensure that the seat belt is positioned correctly. The seat belt should lay flat across the mid-point of your collar bone while in the correct driving position (see [Correct Driving Position](#) on page 28). Adjust the height of the shoulder anchor if the seat belt is not positioned correctly:

1. Press and hold the button on the shoulder anchor to release the locking mechanism.



2. While holding the button, move the shoulder anchor up or down as necessary so that the seat belt is positioned correctly.

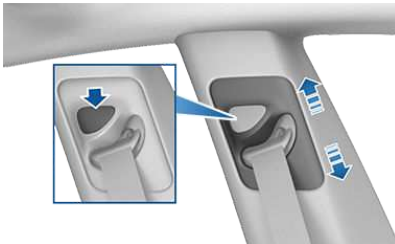

3. Release the button on the shoulder anchor so that it locks into position.
4. Without pressing the button, pull on the seat belt webbing and attempt to move the shoulder anchor downwards to check that it is locked into position.

**Warning:** Ensure that the seat belt is positioned correctly and that the shoulder anchor is locked into position before driving. Riding in a moving vehicle with the seat belt positioned incorrectly or with the shoulder anchor not locked into position can reduce the effectiveness of the seat belt in a collision.

## To Release a Belt

Hold the belt near the buckle to prevent the belt from retracting too quickly, then press the button on the buckle. The belt retracts automatically. Ensure there is no obstruction that prevents the belt from fully retracting. The belt should not hang loose. If a seat belt does not fully retract, contact Tesla.

## Wearing Seat Belts When Pregnant

Do not put the lap or shoulder sections of the seat belt over the abdominal area. Wear the lap section of the belt as low as possible across the hips, not the waist. Position the shoulder portion of the belt between the breasts and to the side of the abdomen. Consult your doctor for specific guidance.



**Warning:** Never place anything between you and the seat belt to cushion the impact in the event of a collision.

## Seat Belt Pre-tensioners

The front seat belts are equipped with pre-tensioners that work in conjunction with the airbags in a severe frontal collision. The pre-tensioners automatically retract both the seat belt anchor and the seat belt webbing, reducing slack in both the lap and diagonal portions of the belts, resulting in reduced forward movement of the occupant.

The second row outboard seats are equipped with shoulder pre-tensioners to retract the seat belt webbing to reduce forward movement of the occupant.

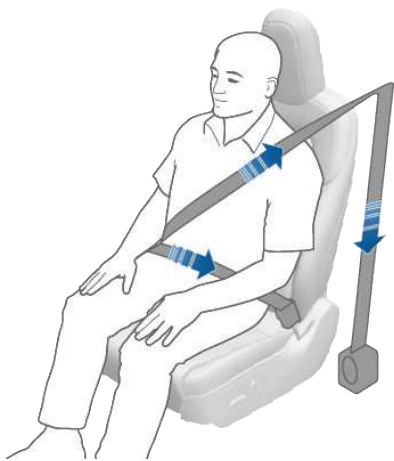

If the pre-tensioners and airbags did not activate in an impact, this does not mean they malfunctioned. It usually means that the strength or type of force needed to activate them was not present.

- Warning:** Once the seat belt pre-tensioners have been activated, they must be replaced. After any collision, have the airbags, seat belt pre-tensioners and any associated components checked and, if necessary, replaced.

## Testing Seat Belts

To confirm that seat belts are operating correctly, perform these three simple checks on each seat belt.

- With the seat belt fastened, give the webbing nearest the buckle a quick pull. The buckle should remain securely locked.
- With the belt unfastened, unreel the webbing to its limit. Check that unreeling is free from snags, and visually check the webbing for wear. Allow the webbing to retract, checking that retraction is smooth and complete.
- With the webbing half unreeled, hold the tongue plate and pull forward quickly. The mechanism should lock automatically and prevent further unreeling.

If a seat belt fails any of these tests, contact Tesla immediately.

For information about cleaning seat belts, see [Seat Belts](#) on page 178.

## Seat Belt Warnings

- Warning:** Seat belts should be worn by all occupants at all times, even if driving for a very short distance. Failure to do so increases the risk of injury or death if a collision occurs.
- Warning:** Secure small children in a suitable child safety seat as described in the Child Safety Seat topic. Always follow the child safety seat manufacturer's instructions when installing.
- Warning:** Ensure that all seat belts are worn correctly. An improperly worn seat belt increases the risk of injury or death if a collision occurs.
- Warning:** Do not wear seat belts over hard, fragile or sharp items in clothing, such as pens, keys, eyeglasses, etc. The pressure from the seat belt on such items can cause injury.
- Warning:** Seat belts should not be worn with any part of the strap twisted.
- Warning:** Each seat belt assembly must be used by one occupant only. It is dangerous to put a seat belt around a child being carried on an occupant's lap.
- Warning:** Seat belts that have been worn in a collision must be inspected or replaced by Tesla, even if damage to the assembly is not obvious.
- Warning:** Seat belts that show signs of wear (such as fraying), or have been cut or damaged in any way, must be replaced by Tesla.
- Warning:** Avoid contaminating a seat belt's components with any chemicals, liquids, grit, dirt or cleaning products. If a seat belt fails to retract or latch into the buckle, it must be replaced immediately. Contact Tesla.
- Warning:** Do not make modifications or additions that can prevent a seat belt mechanism from taking up slack, or that can prevent a seat belt from being adjusted to remove slack. A slack belt greatly reduces occupant protection.
- Warning:** Do not make modifications that can interfere with the operation of a seat belt, or that can cause a seat belt to become inoperable.
- Warning:** When seat belts are not in use, they should be fully retracted and not



hanging loose. If a seat belt does not fully retract, contact Tesla.



## Guidelines for Seating Children

Your Model Y seat belts are designed for adults and larger children. You must restrain infants and small children in the second row seats only, and you must use a suitable child safety seat appropriate for the child's age, weight, and size.

- ⚠ Warning:** Never seat a child on a rear facing child seat with an ACTIVE AIRBAG in front of it. DEATH or SERIOUS INJURY to the child can occur. See [Passenger Front Airbag Status](#) on page 45.
- ⚠ Warning:** Never seat a child on a seat with an ACTIVE AIRBAG in front of it. DEATH or SERIOUS INJURY to the child can occur.
- ⚠ Warning:** Always ensure that all Model Y seats are locked in position before traveling. Failure to do so increases the risk of injury. Pay attention to all warnings displayed on the touchscreen.
- ⚠ Warning:** Do not associate the **Easy Entry** setting with the driver's profile when a child is seated in the second row. Doing so can cause the driver's seat to push against the child, especially when a child is seated in a forward-facing child seat or booster seat. Do not rely on Model Y to recognize or accommodate a child seated in the second row while using this setting (see [Driver Profiles](#) on page 50).

Refer to the following label fitted to the sun visors.

**Note:** The image shown below is representative only and may not be identical to the label(s) in your vehicle.



Model Y has an occupancy sensor in the front passenger seat that controls the status of the passenger front airbag (see [Airbags](#) on page 43).



When driving with a child seat on the front passenger seat, always double-check the status of the passenger front airbag to confirm that it is OFF.



To protect an adult subsequently occupying the front passenger seat, check to verify that the passenger front airbag is ON.



## Choosing a Child Safety Seat

All children age 12 and under should ride in the second and third row seats. Always use a child safety seat suitable for a young child's age and weight. The following table is based on child safety seat recommendations determined by the National Highway Traffic Safety Administration (NHTSA) in the United States (for more information, go to [www.nhtsa.gov/ChildSafety/Guidance](http://www.nhtsa.gov/ChildSafety/Guidance)).

	Infants	Toddlers	Young children
Age	Birth to 1 year*	Over 1 year*	4 years and older, and less than 57 in. (145 cm) tall
Weight	Up to at least 20 lbs (9 kg)**	Over 20 lbs (9 kg) (minimum) and up to 40 lbs (18 kg)*	Over 40 lbs (18 kg)
Type of child safety seat	Rear facing (or convertible)	Forward facing (or convertible)*	Seat belt retained booster seat
Seat position	Rear facing only*	Forward facing*	Forward facing
Recommended attachment method	If combined weight of child and safety seat is up to 65 lbs (29.5 kg), attach using either LATCH** (lower anchor only) or the seat belt only.*** If combined weight of child and safety seat is over 65 lbs (29.5 kg), attach using the seat belt only.***	If combined weight of child and safety seat is up to 65 lbs (29.5 kg), attach using either LATCH** (both lower anchors and top tether anchor), or the seat belt and upper tether strap.*** If combined weight of child and safety seat is over 65 lbs (29.5 kg), attach using the seat belt and upper tether strap.***	Attach booster seats using the seat belt only.

\* Many child safety seats currently available allow children to ride rear-facing using the child safety seat's integrated 5-point harness for a longer period of time BASED UPON SPECIFIC HEIGHT AND WEIGHT LIMITS. Keep your child in a rear facing seat for as long as possible. CHECK THE CHILD SAFETY SEAT MANUFACTURER'S INSTRUCTIONS AND CAREFULLY FOLLOW ALL INSTRUCTIONS

\*\* ISOFIX is the international standard for attachment points for [child safety seats](#) in passenger cars. The system has other regional names including LATCH ("Lower Anchors and Tethers for Children") in the United States and LUAS ("Lower Universal Anchorage System") or Confix in Canada. It has also been called the "Universal Child Safety Seat System" or UCSSS.

\*\*\* Subject to instructions provided by the child safety seat manufacturer.

**⚠ Warning:** Laws that govern how and where children should be carried when traveling in a vehicle are subject to change. It is the driver's responsibility to keep up to date on, and comply with, all current regulations in the region(s) where Model Y is driven. To check the child passenger safety laws for states in the U.S., go to: [http://www.ghsa.org/html/stateinfo/laws/childsafety\\_laws.html](http://www.ghsa.org/html/stateinfo/laws/childsafety_laws.html).

**⚠ Warning:** Do not use LATCH/Isfix/i-Size anchors with child restraint system or booster seats that have an integral safety belt where the combined weight of the child plus the child restraint system exceeds 65 lbs (29.5 kg).



**Warning:** Do not use **Easy Entry** (as described in [Driver Profiles](#) on page 50) to automatically move the driver's seat to the full rearward position if a child safety seat is installed on a rear seat behind the driver's seat. With reduced clearance, the movement of the seat may impact a child's legs, cause injury, or dislodge the seat.



## Seating Larger Children

If a child is too large to fit into a child safety seat, but too small to safely fit into the standard seat belts, use a booster seat appropriate for the child's age and size. Carefully follow the manufacturer's instructions to secure the booster seat.

## Installing Child Safety Seats

There are two general methods used to install child safety seats:

- Seat belt retained - these seats are secured using the vehicle's seat belts.
- LATCH retained - these seats attach to anchor bars built into the vehicle's rear seats.

Check the child safety seat manufacturer's instructions and the table provided in this document to determine which installation method to use. Some child safety seats can be installed using either method. Always follow the child safety seat manufacturer's instructions.

## Installing Seat Belt Retained Child Seats

First, make sure that the child safety seat is appropriate for the weight, height, and age of the child.

Avoid dressing the child in bulky clothing and do not place any objects between the child and the restraint system.

Adjust harnesses for every child, every trip.

To securely hold child safety seats, all passenger seating positions are equipped with an automatic locking retractor (ALR) that, by pulling the seat belt beyond the length needed for a typical adult occupant, locks the belt into place until the seat belt is unbuckled and the webbing is fully retracted. The ALR mechanism operates as a ratchet, winding in slack and preventing the seat belt from extending any further until it has been completely rewound. When installing a child safety seat, engage the belt's automatic locking retractor by pulling the seat belt webbing until it is fully extended. The ALR system engages only when the seat belt is at its maximum extension point.

**Note:** An automatic locking retractor disengages only when the seat belt is unbuckled and fully retracted. The belt can then be worn as a normal belt, sliding freely in

and out and locking tight only in an emergency. Once disengaged, the belt must be fully extended to re-engage the locking mechanism whenever you install a child safety seat.

Always follow the detailed instructions provided by the child safety seat manufacturer. General guidelines are provided below.

1. Place the child safety seat in Model Y, and fully extend the seat belt. Route and buckle the seat belt in accordance with the child safety seat manufacturer's instructions.



2. Allow the seat belt to retract, and remove all slack in the seat belt while firmly pushing the child safety seat into the Model Y seat.
3. If the seat belt retained child safety seat has an upper tether, attach it to the back of the seat (see [Attaching Upper Tether Straps](#) on page 40).

## Installing LATCH (ISOFIX) Child Seats

Lower LATCH anchors are provided in the second row outboard seats. The anchors are located between the seat's back rest and rear cushion. The exact location of each anchor is identified by a child safety seat identification button, illustrated below. The button is located on the seat, near the associated anchor.





In the second row, install LATCH child safety seats in the outboard seating positions only. Use only a seat belt retained seat in the center position.



To install a LATCH child safety seat, slide the safety seat latches onto the anchor bars until they click into place. Carefully read and follow the instructions provided by the child safety seat manufacturer.



Once installed, test the security of the installation before seating a child. Attempt to twist the child safety seat from side to side and try to pull it away from the seat, then check to ensure the anchors remain securely in place.

**Note:** Lower LATCH anchors should not be used with child seats or booster seats that have an integrated safety belt in situations where the combined weight of the child plus the child restraint is more than 65 lbs (29.5 kg). In these situations, use the safety belt instead.

## Attaching Upper Tether Straps

If an upper tether strap is provided, attach its hook to the anchor point located behind the rear seat.

**Note:** The location of anchor points may not be readily visible but can be found by identifying a slice in the seat's material.

- Warning:** Tighten upper tether straps according to the instructions provided by the manufacturer of the child safety seat.
- Warning:** USE ONLY SEAT BELT RETAINED CHILD SAFETY SEATS IN THE CENTER SEATING POSITION.



Make sure the hook is fully seated on the anchor point.



For dual-strap tethers, position a strap on each side of the head support.

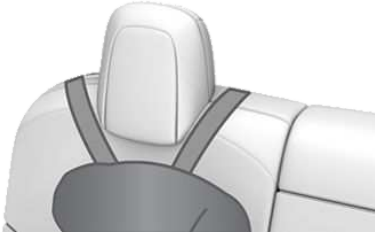

For a single-strap tether at an outboard seating positions, raise the head support (see [Raising/Lowering the Outer Rear Seat Head Supports](#) on page 30) and run the strap under the head support.

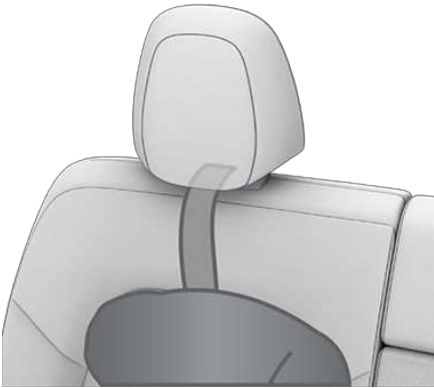

For a single-strap tether at the center seating position, raise the head support (see [Raising/Lowering the Rear Center Head Support](#) on page 30) and run the strap under the head support.

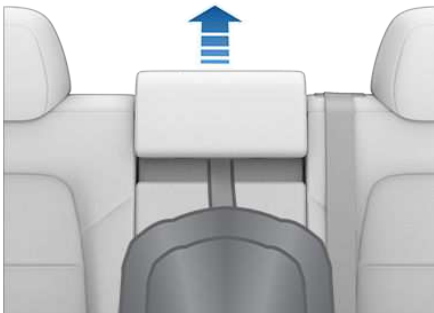

## Testing a Child Safety Seat







Before seating a child, always make sure the child safety seat is not loose:

1. Hold the child safety seat by the belt path and try to slide the safety seat from side to side and front to back.
2. If the seat moves more than one inch (2.5 cm), it is too loose. Tighten the belt or reconnect the LATCH retained child safety seat.
3. If you are unable to reduce slack, try a different seat location or try another child safety seat.

## Child Safety Seat Warnings

- ⚠ Warning:** Extreme hazard! Do not seat a child on the front passenger seat even if you are using a child safety seat. This seat has an airbag in front of it. Although this airbag is disabled when Model Y detects a lightweight passenger, do not rely on technology to protect your child.
- ⚠ Warning:** Child restraint systems are designed to be secured in vehicle seats by lap belts or the lap belt portion of a lap-shoulder belt. Children could be endangered in a crash if their child restraints are not properly secured in the vehicle.
- ⚠ Warning:** According to collision statistics, children are safer when properly restrained in the rear seating positions than in the front seating positions.
- ⚠ Warning:** Do not use a forward facing child safety seat until your child weighs over 20 lbs (9 kg) and can sit independently. Up to the age of two, a child's spine and neck are not sufficiently developed to avoid injury in a frontal impact.
- ⚠ Warning:** Do not allow a baby or infant to be held on a lap. All children should be restrained in an appropriate child safety seat at all times.
- ⚠ Warning:** To ensure children are safely seated, follow all instructions provided in this document and by the manufacturer of the child safety seat.
- ⚠ Warning:** Children should ride in a rear facing child safety seat using the seat's integrated 5-point harness for as long as possible.



-  **Warning:** Do not use seat belt extenders on a seat belt that is being used to install a child safety seat or booster seat.
-  **Warning:** When seating larger children, make sure the child's head is supported and the child's seat belt is properly adjusted and fastened. The shoulder portion of the belt must be away from the face and neck, and the lap portion must not be over the stomach.
-  **Warning:** Never attach two child safety seats to one anchor point. In a collision, one anchor point may be incapable of securing both seats.
-  **Warning:** Child restraint anchors are designed to withstand only those loads imposed by correctly fitted child restraints. Under no circumstances are they to be used for adult seat belts, harnesses, or for attaching other items or equipment to the vehicle.
-  **Warning:** Always check harnesses and tether straps for damage and wear.
-  **Warning:** Never leave a child unattended, even if the child is secured in a child safety seat.
-  **Warning:** Never use a child safety seat that has been involved in a collision. Have the seat inspected or replaced as described in the child safety seat manufacturer's instructions.



## Location of Airbags

Airbags are located in the approximate areas shown below. Airbag warning information is printed on the sun visors.

Model Y is equipped with an airbag and lap/shoulder belt at both front seating positions. The airbag is a supplemental restraint at those seating positions. All occupants, including the driver, should always wear their seat belts whether or not an airbag is also provided at their seating position to minimize the risk of severe injury or death in the event of a crash.

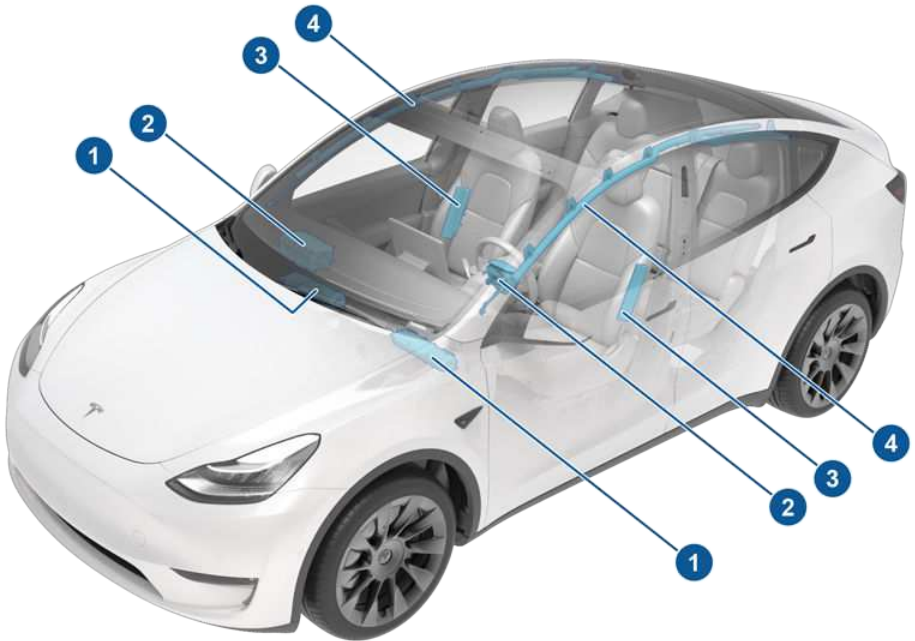

1. Knee airbag
2. Front airbags
3. Seat-mounted side airbags
4. Curtain airbags



## How Airbags Work

Airbags inflate when sensors detect an impact that exceeds deployment thresholds. These thresholds are designed to predict the severity of a crash in time for the airbags to help protect the vehicle's occupants. Airbags inflate instantly with considerable force accompanied by a loud noise. The inflated bag, together with the seat belts, limits movement of occupants to reduce the risk of injury.

Front airbags are not ordinarily designed to inflate in rear collisions, rollovers, side collisions and when braking heavily or driving over bumps and potholes. Likewise, front airbags may not inflate in all frontal collisions, such as minor front collisions, underride collisions, or minor impacts with narrow objects (such as posts or poles). Significant superficial damage can occur to the vehicle without the airbags inflating and, conversely, a relatively small amount of structural damage can cause airbags to inflate. Therefore, the external appearance of the vehicle after a collision does not represent whether or not the front airbags should have inflated.

**⚠ Warning:** Before modifying your vehicle to accommodate a person with disabilities in a way that may affect the airbag system, contact Tesla.

## Types of Airbags

Model Y has the following types of airbags:

- **Front airbags:** The front airbags are designed to reduce injuries if larger children or adults are riding in the front seats. Follow all warnings and instructions related to seating a child on the front passenger seat (if permitted in your market region). See [Child Safety Seats](#) on page 36.
- **Knee airbags:** Knee airbags and the front airbags work together. The knee airbags limit the forward motion of the front seat occupants by restricting leg movement, thereby positioning the occupants so that the front airbags work more effectively.
- **Seat-mounted side airbags:** A seat-mounted side airbag in the front seats helps protect the pelvis and the thorax region of the torso. The seat-mounted side airbags on both the impacted and non-impacted side of the vehicle will inflate in the event of severe side impact or severe offset frontal impact.

- **Curtain airbags:** Curtain airbags help protect the head. Curtain airbags on both the impacted and non-impacted side of the vehicle will inflate only if a severe side impact occurs, or if the vehicle rolls over.



## Passenger Front Airbag Status

The status of the passenger front airbag displays in the top corner of the touchscreen:



Before driving with a child seat on the front passenger seat (if legally permitted in your market region), always double-check the status of the passenger front airbag to confirm that it is OFF. When the passenger front airbag is OFF, it will not inflate when a collision occurs. This indicator also displays when the seat is unoccupied.



To protect an adult occupying the front passenger seat, ensure the passenger front airbag is ON. When the passenger front airbag is ON, it may inflate when a collision occurs.

## Controlling the Passenger Front Airbag

Model Y has an occupancy sensor in the front passenger seat that controls the status of the front airbag.

**Note:** The occupancy classification system (OCS) meets the regulatory requirement of FMVSS 208 and automatically detects when inflating the passenger front airbag would be unnecessary or potentially harmful.

**Warning:** Seating an infant in a rear facing child safety seat on a seat equipped with an operational airbag can cause serious injury or death.

Object Classification	OCS Passenger Airbag Status*	Indicator status	Notes
Empty	OFF	PASSENGER AIRBAG OFF	
Object	OFF or ON	PASSENGER AIRBAG OFF or PASSENGER AIRBAG ON	Depends on material/ contents.
Rear facing child seat designed for children up to a year old	OFF	PASSENGER AIRBAG OFF	20 lbs (9 kg) or less
Forward facing child seat	OFF	PASSENGER AIRBAG OFF	35 lbs (16 kg) or less
Child in a booster seat	OFF or ON	PASSENGER AIRBAG OFF or PASSENGER AIRBAG ON	20-100 lbs (9-45 kg)*
Large child	OFF or ON	PASSENGER AIRBAG OFF or PASSENGER AIRBAG ON	
5th percentile female or larger (by weight)	ON	PASSENGER AIRBAG ON	Over approximately 100 lbs (45 kg)

\*If the passenger airbag status indicator does not match the situation, do not use the seat. The passenger must ride in a different seat. Contact Tesla Service.

**Note:** It takes approximately six seconds after you power on Model Y for the occupant classification system (OCS) to report accurate status of the front passenger airbag. As a result, when you first power on Model Y, even in situations when it should be OFF because the seat is



occupied by a weight of 20 lbs (9 kg) or less, it will take the touchscreen approximately six seconds to display the status, PASS AIRBAG OFF. If it fails to do so, contact Tesla Service and do not seat a child in the front passenger seating position.

To make sure the sensing system can correctly detect occupancy status, eliminate the following:

- Objects lodged under the seat.
- Heavy objects sitting on the seat (briefcase, large purse).
- Objects wedged between the seat back and seat cushion.
- Cargo interfering with the seat.
- Aftermarket items attached to, or sitting on or between, the seat and occupant including but not limited to covers, mats, blankets, etc.

These conditions can interfere with the occupancy sensor. If you have eliminated the above possibilities, and the airbag status is still incorrect, ask passengers to ride in the rear seats and contact Tesla to have the airbag system checked.

**Note:** The front passenger occupancy sensor affects the operation of the passenger front airbags only. The side airbags are not affected.

 **Warning:** If the front passenger airbag is not turning on or off as expected based on the weight thresholds previously described, contact Tesla immediately.

 **Warning:** If seating a child in the front passenger seat is legally permissible in your market region, it is the driver's responsibility to ensure that the passenger front airbag is OFF. Never seat a child in a rear facing safety seat in the front passenger seat with an active airbag. DEATH or SERIOUS INJURY to the child can occur. Per recommendations by the National Highway Traffic Safety Administration, all occupants age 12 and under must ride in the rear seats.

 **Warning:** Do not use seat covers on Model Y. Doing so could restrict deployment of the seat-mounted side air bags if a collision occurs. It can also reduce the accuracy of the occupant detection system, if equipped.



## Ensuring Accurate Occupant Classification

To help ensure an occupant in the front passenger seat can be accurately classified, the passenger must:

- Wear a seat belt.
- Sit upright on the center of the seat cushion, with shoulders resting against the seat back and legs extended comfortably in front with feet on the floor. See [Examples of Correct and Incorrect Seating Positions](#) on page 48.
- Remain positioned on the seat cushion and not lift their weight off the seat (for example, by pushing their feet against the floor or pressing on the center console or armrest to lift up).
- Never wear thick, wet, or bulky clothing (such as ski wear or padded clothing).

In addition to the items listed above, the following situations can interfere with the accuracy of the occupant classification system:





- Placing a radio transmitter (for example, a hunting radio or walkie-talkie) on the front passenger seat.
- Placing an AC/DC inverter, or a device that is being powered by the inverter (for example, a cell phone, tablet, or computer) on the front passenger seat cushion.
- Placing liquid (such as a bottled drink) or food containers on a car seat when a child seat is present.
- Incorrectly placing a child safety seat so that the entire lower section is not positioned against the seat cushion.
- Objects lodged under the seat or wedged between the seat back and cushion.
- Heavy objects sitting on the seat (briefcase, large purse).
- Cargo interfering with the seat.
- Aftermarket items attached to or placed between the seat and the occupant, such as covers, mats, blankets, etc.

These conditions can interfere with the occupancy sensor. If you have eliminated the above possibilities, and the airbag status is still incorrect, instruct passengers to ride in the rear seats and contact Tesla to have the airbag system checked.

**Note:** Tesla follows NHTSA (National Highway Traffic Safety Administration)

recommendations that all occupants age 12 and under must ride in a rear seating position.

**Note:** The front passenger occupancy sensor affects the operation of the passenger front airbags only. The side airbags are not affected.

-  **Warning:** Failure to follow the above instructions can adversely affect the Occupant Classification System (OCS) which can cause serious injury or death.
-  **Warning:** If the front passenger airbag is not turning on or off as expected, do not seat a passenger in the front passenger seat. Contact Tesla Service.
-  **Warning:** To ensure accuracy of the occupant detection system, do not make any modifications to the front passenger seat.
-  **Warning:** Do not use seat covers on Model Y. Doing so could restrict deployment of the seat-mounted side air bags if a collision occurs. It can also reduce the accuracy of the occupant classification system.





## Examples of Correct and Incorrect Seating Positions

Correct seating position:

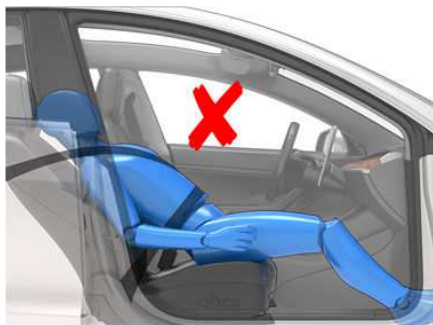

Incorrect seating position - the passenger's feet must be on the floor:



Incorrect seating position - the passenger must not slide forward on the seat cushion:



Incorrect seating position - the passenger must not recline the backrest to a laying down position when the vehicle is moving:



## Inflation Effects

- Warning:** When airbags inflate, a fine powder is released. This powder can irritate the skin and should be thoroughly flushed from the eyes and from any cuts or abrasions.

After inflation, the airbags deflate to provide a gradual cushioning effect for the occupants and to ensure the driver's forward vision is not obscured.

If airbags have inflated, or if your vehicle has been in a collision, your vehicle requires servicing before it will power up. In addition, your airbags, seat belt pre-tensioners and any associated components must be checked, and if necessary, replaced. Contact Tesla Service immediately.

In a collision, in addition to the airbags inflating:

- Doors unlock.
- Hazard warning lights turn on.
- Interior lights turn on.
- High voltage is disabled.

**Note:** In some collisions, even if airbags did not inflate, high voltage may be disabled and you will be unable to power up and drive. Contact Tesla Service immediately.

## Airbag Warning Indicator



The airbag indicator on the touchscreen remains lit if the airbag system is malfunctioning. The only time this indicator should light up is briefly when Model Y first powers up, in which case it turns off within a few seconds. If it remains lit, contact Tesla immediately and do not drive.

## Airbag Warnings

- Warning:** All occupants, including the driver, should always wear their seat belts, whether or not an airbag is also provided at their seating position, to minimize the risk of severe injury or death in the event of a collision.
- Warning:** Front seat occupants should not place their arms over the airbag module, as an inflating airbag can cause fractures or other injuries.
- Warning:** Do not use seat covers on Model Y. Doing so could restrict deployment of the seat-mounted side air bags if a collision occurs. It can also reduce the accuracy of the occupant detection system, if equipped.
- Warning:** Airbags inflate with considerable speed and force, which can cause injury. To limit injuries, ensure that occupants are wearing seat belts and are correctly seated, with the seat positioned as far back as possible. The National Highway Traffic Safety Administration (NHTSA) recommends a minimum distance of 10" (25 cm) between an occupant's chest and an airbag.
- Warning:** Children should not be seated on the front passenger seat unless permitted by regulations in your market region. Follow all regulations in your region for the appropriate way to seat a child based on the child's weight, size, and age. The safest place to seat infants and young children is in a rear seating position. Seating an infant or child in a rear-facing child restraint system on a seat equipped with an operational airbag can cause serious injury or death.
- Warning:** Do not use a rear-facing child safety seat on a seat with an operational airbag in front of it. Doing so can cause injury or death if the airbag inflates.
- Warning:** To ensure correct inflation of the side airbags, maintain an unobstructed gap between an occupant's torso and the side of Model Y.
- Warning:** Passengers shouldn't lean their heads against doors. Doing so can cause injury if a curtain airbag inflates.
- Warning:** Do not allow passengers to obstruct the operation of an airbag by placing feet, knees or any other part of the body on or near an airbag.
- Warning:** Do not attach or place objects on or near the front airbags, the side of the front seats, the headliner at the side of the vehicle, or any other airbag cover that could interfere with inflation of an airbag. Objects can cause serious injury if the vehicle is in a collision severe enough to cause the airbag to inflate.
- Warning:** Following inflation, some airbag components are hot. Do not touch until they have cooled.



## Creating a Driver Profile

When you first adjust the driver's seat, steering wheel, or driver's side mirror, the touchscreen prompts you to create a driver profile to save these adjustments. Your profile also saves some of the preferences you make using the touchscreen's **Controls** window.



To add a new driver profile, touch the driver profile icon at the top of the touchscreen. Then touch **Add New Driver**, type the driver's name and touch **Create Profile**. Follow the onscreen instructions to save the seating position to the driver profile. You can also check the **Use Easy Entry** checkbox if you want to save (or use existing) Easy Entry settings (described below) in which the driver's seat and the steering wheel are automatically adjusted to make it easy to enter and exit Model Y.

If you change the position of the steering wheel, driver's seat, or driver's side mirror after you have saved or chosen a driver profile, the touchscreen prompts you to save the new position or restore the previously saved position (other settings are automatically saved). To change a setting without saving or restoring, just ignore the prompt.

To adjust Model Y based on a driver's profile, touch the driver profile icon and choose the driver name. The saved adjustments are automatically made.

**Note:** Valet mode is a built-in driver profile used to limit speed and restrict access to some Model Y features (see [Valet Mode](#) on page 51).

**Note:** To stop automatic adjustments that are in process based on a driver's profile, touch Stop on the Driver Profile dropdown menu. Automatic adjustments also stop if you manually adjust a seat, mirror or the steering wheel.

## Easy Entry

You can define an Easy Entry setting that moves the steering wheel and driver's seat to make it easy to enter and exit Model Y. Any driver can use the Easy Entry setting by associating it with their driver's profile. When the Easy Entry setting is associated with a driver's profile, the steering wheel and driver's seat automatically adjust when the park gear is engaged and the driver's seat belt is unbuckled, allowing an easy exit from the vehicle. When returning to the vehicle and stepping on the brake pedal, settings automatically adjust back to the settings used by the most recent driver profile (or based on the key if it's linked to a driver profile).

To use **Easy Entry** with a driver profile, ensure the **Use Easy Entry** box is checked.



**Warning:** Never use Easy Entry to move the driver's seat to the full rearward position when a child safety seat is installed on a rear seat located behind the driver's seat. With reduced clearance, the movement of the seat may impact a child's legs, cause injury, or dislodge the seat.

## Restoring a Driver's Profile



To adjust Model Y based on a driver's profile, touch the driver profile icon on the touchscreen's status bar. Then choose the driver and Model Y is adjusted based on the settings that have been saved to the chosen driver profile.

## Saved Settings

A subset of the settings that you choose from the Controls window to customize your Model Y are also saved to your driver's profile. The settings that are associated with driver profiles may vary depending on the version of software currently installed on your Model Y.



## Linking a Driver Profile to a Key

You can link a driver profile to a key (or keys) to allow Model Y to automatically select the correct driver profile when the linked key is detected as you approach the vehicle and open the driver's door. To link a driver profile to a key, first ensure you are using your desired driver profile. Navigate to **Controls** > **Locks** and touch the **+** icon. You can add an authenticated phone, key card, or key fob by following the onscreen instructions. When finished pairing, touch the driver icon to link the key to the desired driver profile. The name of the driver profile will appear under the key to show that it is linked.

**Note:** Model Y can support up to 19 linked keys including authenticated phones, key cards, and up to four key fobs. However, Model Y only supports up to 10 driver profiles. You can link multiple keys to a driver profile, but you cannot link multiple driver profiles to a single key.

## Valet Mode

When Model Y is in Valet mode, the following restrictions apply:

- Speed is limited to 70 mph (113 km/h).
- Maximum acceleration and power are limited.
- Front trunk and glovebox are locked.
- Home and Work locations are not available in the navigation system.
- Voice commands are disabled.
- Autopilot convenience features are disabled.
- The Allow Mobile Access setting is disabled.
- HomeLink (if applicable in your market region) is not accessible.
- Driver Profiles are not accessible.
- The touchscreen does not display the list of keys that can access Model Y (see [Managing Keys](#) on page 12).
- Wi-Fi and Bluetooth are disabled. When Model Y is in Valet mode, you cannot pair new Bluetooth devices or view or delete existing paired devices.

**Note:** If a Bluetooth paired device or a known Wi-Fi network is within operating range (approximately 30 feet or 9 meters) of Model Y in Valet mode, Model Y will connect to it.

## Starting Valet Mode

With Model Y in Park, touch the driver profile icon on the top of the touchscreen, then touch **Valet Mode**.

The first time you enter Valet mode, you will be prompted to create a 4-digit PIN that you will use to cancel Valet mode.

When Valet mode is active, the touchscreen displays the word **Valet** above the driving speed and the Valet mode driver profile displays on the touchscreen.

You can also use the mobile app to start and cancel Valet mode (provided Model Y is in Park). When using the mobile app, you do not need to enter a PIN because you are already required to log into the app using your Tesla Account credentials.

**Note:** If the **PIN to Drive** setting is enabled (see [PIN to Drive](#) on page 145), you must enter the driving PIN before you can define or enter a Valet PIN. Once in Valet mode, Model Y can be driven without the valet needing to enter the driving PIN.

**Note:** The **PIN to Drive** setting is not available when Valet mode is active.

If you forget your valet PIN, reset it from inside Model Y by entering your Tesla Account credentials (which also cancels Valet mode). You can also reset your PIN using the mobile app.

## Canceling Valet Mode

With Model Y in Park, touch the **Valet Mode** driver icon on the touchscreen's status bar, then enter your 4-digit PIN.

When you cancel Valet mode, all settings associated with the most recently used driver profile and climate control settings are restored, and all features are available.

**Note:** You do not need to enter a PIN to cancel Valet mode from the mobile app.



## Scroll Buttons

A scroll button is located on each side of the steering wheel. Use your thumb to press this button to the right or left. You can also press the button or roll it up or down.

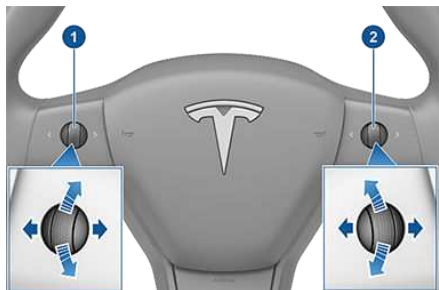

### 1. Use the left scroll button to:

- Control the volume. Press the scroll button to mute/unmute the volume, roll the scroll button up to increase the volume, or down to decrease the volume.
- Push the scroll button to the right to go to the next song, station, or Favorite (depending on what's playing). Push the scroll button to the left to return to the previous selection.
- Adjust the position of the exterior mirrors (see [Adjusting Exterior Mirrors](#) on page 54).
- Adjust the position of the steering wheel (see [Adjusting Steering Wheel Position](#) on page 52).
- Adjust the angle of the headlights (see [Headlight Adjustments](#) on page 62).

**Note:** The scroll button adjusts the volume for media, navigation instructions or phone calls based on what is currently in use. As you adjust volume, the touchscreen displays the volume level and whether you are adjusting volume for media, navigation or phone calls.

### 2. Use the right scroll button to:

- Speak a voice command. Press the button to initiate a voice command (see [Using Voice Commands](#) on page 144).

- Adjust your set speed and the distance you want to maintain from a vehicle traveling ahead of you (see [Traffic-Aware Cruise Control](#) on page 85).

**Note:** The arrows associated with the scroll buttons are backlit in low ambient lighting conditions. To turn this backlighting on or off, touch **Controls > Lights > Steering Wheel Lights**.

To restart the touchscreen, press and hold both scroll buttons until after the touchscreen turns black. See [Restarting the Touchscreen](#) on page 56.

## Adjusting Steering Wheel Position

To adjust the steering wheel, touch **Controls > Quick Controls > Adjustments > Steering Wheel**. Use the left scroll buttons on the steering wheel to move the steering wheel to the desired position:

- To adjust the height/tilt angle of the steering wheel, roll the left scroll button up or down.
- To move the steering wheel closer to you, or further away from you, press the left scroll button to the left or right.



**Warning:** Do not make steering wheel adjustments while driving.

## Adjusting Steering Effort

You can adjust the feel and sensitivity of the steering system to suit your personal preference:

- On the touchscreen, touch **Controls > Driving > Steering Mode**.
- Choose a steering option:



- **Comfort** - Reduces the effort required to turn the wheel. In town, Model Y feels easier to drive and park.
- **Standard** - Tesla believes that this setting offers the best handling and response in all conditions.
- **Sport** - Increases the effort required to turn the wheel. When driving at higher speeds, Model Y feels more responsive.

The only way to really know which option you like best is to try them.

## Horn

To sound the horn, press the center pad on the steering wheel.

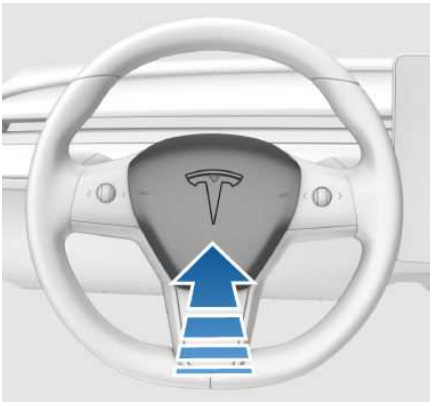



## Adjusting Exterior Mirrors

Adjust the exterior mirrors by touching **Controls** > **Quick Controls** > **Mirrors**. You can choose which mirror you would like to adjust by selecting **Left** or **Right** on the touchscreen. Use the left scroll button on the steering wheel to adjust the mirror to its desired position:

**Note:** You can also press the left scroll button to change which mirror you are adjusting.

- To move the mirror up or down, roll the left scroll button up or down.
- To move the mirror inward or outward, press the left scroll button to the left or right.

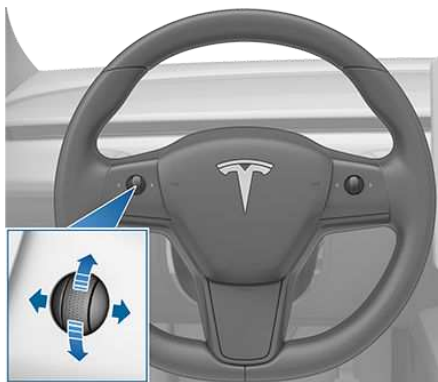

Both exterior mirrors have heaters that turn on and off with the rear window defroster.

You can fold the mirrors inward for parking in tight spaces by touching **Controls** > **Quick Controls** > **Fold**. The mirrors remain folded until your driving speed reaches 31 mph (50 km/h), or until you touch **Fold** again to unfold the mirrors.

**Note:** See [Cold Weather Best Practices](#) on page 80 for information to ensure your mirrors function properly in cold weather.

**Note:** You cannot fold a mirror if driving faster than 31 mph (50 km/h).

### Auto-Fold Mirrors Based on Location

Model Y can automatically fold and unfold the side mirrors based on location, which saves you from having to manually position them each time you need to fold or unfold the mirrors when at a frequented place (such as narrow garages, tight parking spaces, etc.).

To set up, Model Y must be driving at a low speed (less than 3 mph (5 km/h)) or stopped at the location you want your vehicle to remember. Go to **Controls** > **Quick Controls** > **Mirrors** > **Always Fold Mirrors at this Location**. Next time you approach the saved location, your mirrors fold and unfold within 25 feet (7.5 meters) of the specified location.

You can also integrate auto-folding mirrors with HomeLink (see [HomeLink Universal Transceiver](#) on page 149). To enable, go to **HomeLink** > **Auto-Fold Mirrors when Nearby**.

**⚠ Caution:** Mirrors may not automatically fold or unfold if you return to a saved location and are driving faster than 3 mph (5 km/h).

### Mirror Auto Tilt

Both exterior mirrors can automatically tilt downward when Model Y is shifted into Reverse. When you shift back into Drive, the mirrors return to their normal (upward) position.

To turn this feature on or off, touch **Controls** > **Quick Controls** > **Mirrors** > **Mirror Auto Tilt**.

### Mirror Auto Fold

Both exterior mirrors can automatically fold inward whenever you exit and lock Model Y. When you unlock Model Y, the exterior mirrors then automatically unfold.

To turn this feature on or off, touch **Controls** > **Quick Controls** > **Mirrors** > **Mirror Auto Fold**.

### Rear View Mirror

The rear view mirror is adjusted manually. When in the Drive or Neutral gear, the rear view mirror automatically dims in low lighting conditions (for example, when driving at night or through a tunnel).

### Vanity Mirrors

To expose and illuminate the vanity mirror, fold the sun visor downwards, then use the tab to lower the mirror cover. When you close the mirror cover, the light turns off.

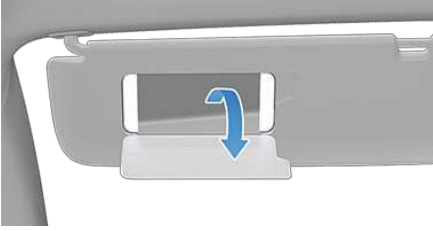





## Starting

When you open a door, Model Y powers on the touchscreen and you can operate all controls.

To drive Model Y:

1. **PRESS THE BRAKE PEDAL** - Model Y powers on and is ready to drive.
2. **SELECT A GEAR** - Move the gear lever all the way down for Drive and all the way up for Reverse. See [Shifting Gears](#) on page 58.

**Note:** If the PIN to Drive feature is enabled (see [PIN to Drive](#) on page 145), you must also enter a valid PIN on the touchscreen before you can drive Model Y.

**Note:** If Passive Entry is off and you do not press the brake pedal to start Model Y within approximately five minutes, a message displays on the touchscreen and you must use the key to lock then unlock Model Y again before starting the vehicle.

Everything you need to know when driving Model Y displays on the touchscreen.

### Drive Disabled - Requires Authentication

If Model Y does not detect a key when you press the brake (an authenticated phone is not detected, or 30 seconds has passed since you used the key card), the touchscreen displays a message telling you that driving requires authentication.

If you see this message, place the key card behind the cup holders on the top of the center console where the RFID transmitter can read it. The 30 second authentication window restarts and you can start Model Y by pressing the brake pedal.

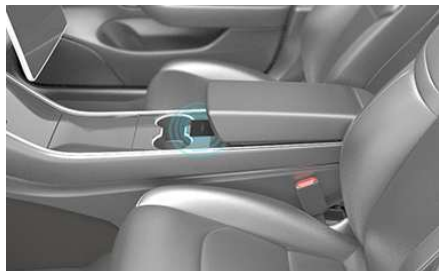

A number of factors can affect whether Model Y can detect an authenticated phone (for example, the phone's battery is low or dead and is no longer able to communicate using Bluetooth).

Always keep your authenticated phone and a key card with you. After driving, your authenticated phone or key card is needed to restart Model Y after it powers off. And when you leave Model Y, you must bring your authenticated phone or key card with you to lock Model Y, either manually or automatically.

## Powering Off

When you finish driving, shift into Park by pressing the button on the end of the gear selector. The parking brake automatically engages and all systems keep operating. When you leave Model Y with your authenticated phone and key card, it powers off automatically, turning off the touchscreen.

Model Y also powers off automatically after being in Park for 15 minutes, even if you are sitting in the driver's seat.

Although usually not needed, you can power off Model Y while sitting in the driver's seat, provided the vehicle is not moving. Touch **Controls > Safety & Security > Power Off**. Model Y automatically powers back on again if you press the brake pedal or touch the touchscreen.

**Note:** Model Y automatically shifts into Park whenever it is determined that you are exiting the vehicle, even when you shift into Neutral before exiting. To keep Model Y in Neutral, you will need to activate Transport Mode (see [Instructions for Transporters](#) on page 203).

## Restarting the Touchscreen

If your touchscreen is unresponsive or demonstrates unusual behavior, you can restart it to potentially resolve the issue.

**Warning:** Only restart the touchscreen while the vehicle is stopped and in Park. The car status display, safety warnings, backup camera, etc. will not be visible during the restart.

1. Shift into Park.



2. Hold down both scroll buttons on the steering wheel until the touchscreen turns black.

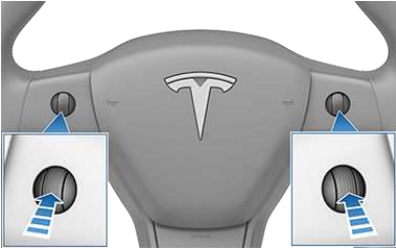

3. After a few seconds, the Tesla logo appears. Wait approximately 30 seconds for the touchscreen to restart. If the touchscreen is still unresponsive or demonstrating unusual behavior after a few minutes, try power cycling the vehicle. See [Power Cycling the Vehicle](#) on page 57.

**Note:** Restarting the touchscreen using the scroll buttons does not power Model Y off and on.

## Power Cycling the Vehicle

If your vehicle demonstrates unusual behavior or a nondescript alert is present, you can try power cycling the vehicle to potentially resolve the issue.

1. Shift into Park.
2. On the touchscreen, touch **Controls** > **Safety & Security** > **Power Off**.
3. Wait for at least two minutes without interacting with the vehicle. Do not open the doors, touch the brake pedal, touch the touchscreen, etc.
4. After two minutes have passed, press the brake pedal or open the door to wake the vehicle.



## Shifting Gears

When Model Y is in Park, you must press the brake to shift to another gear.

Move the lever up or down to change gears.



If you try to shift into a gear that the current driving speed prohibits, a chime sounds and the gear does not change.

### Reverse

Push the lever all the way up and release. You can only shift into Reverse when Model Y is stopped or moving less than 5 mph (8 km/h). If moving less than 1 mph (1.6 km/h), you must press the brake.

### Neutral

Push the lever up or down to the first position and hold it there for more than 1 second to shift into Neutral. Neutral allows Model Y to roll freely when you are not pressing the brake pedal.

Model Y automatically shifts into Park when you leave the driver's seat. To stay in Neutral, use the touchscreen to engage Transport Mode (see [Instructions for Transporters](#) on page 203).

### Drive

Push the lever all the way down and release. You can shift into Drive when Model Y is stopped or moving less than 5 mph (8 km/h) in Reverse. If Model Y is moving less than 1 mph (1.6 km/h), you must press the brake to shift into Drive.

**Note:** When in Drive, push the lever all the way down and release to enable Traffic-Aware Cruise Control (see [Traffic-Aware Cruise Control](#) on page 85). Push the lever all the way down twice in quick succession to enable Autosteer (see [Autosteer](#) on page 91).

### Park

Press the end of the gear selector while Model Y is stopped. Whenever Model Y is in Park, the parking brake is applied.



Model Y automatically shifts into Park whenever you connect a charge cable or if two or more of the following conditions are met simultaneously while traveling slower than approximately 1.5 mph (2 km/h):

- The driver's seat belt is unbuckled.
- The occupancy sensor in the driver's seat does not detect an occupant.
- The driver's door is opened.

**Note:** The above conditions do not reflect a comprehensive list of reasons why Model Y may or may not automatically shift into Park and, in certain scenarios, it is possible for your vehicle to shift into Park when only one of the above conditions is true.

**⚠ Caution:** Model Y will not shift out of Park if the front trunk is not securely shut or if the charge port is unable to determine whether a charging cable is plugged in. Ensure the front trunk is closed and any charging cables are unplugged, and follow the directions on the touchscreen to proceed.

**⚠ Warning:** In emergency situations, if the brakes are not functioning properly, press and hold the Park button on the gear selector to bring the vehicle to a stop. Do not use this method to stop the vehicle unless absolutely necessary.



**⚠ Warning:** It is the driver's responsibility to always ensure the vehicle is in Park before exiting. Never rely on Model Y to automatically shift into Park for you; it might not work in all circumstances (for example, if Creep or a slope causes the vehicle to travel greater than approximately 1.5 mph (2 km/h)).

To make it convenient to pick up passengers, you can also unlock all doors at any time by shifting into Park then pressing the Park button a second time.



## Controlling Lights

Touch **Controls > Lights** on the touchscreen to control the lights.

In addition to the lights that you can control from the touchscreen, Model Y has convenience lights that operate automatically based on what you are doing. For example, in low ambient lighting conditions, the interior lights, marker lights, tail lights, and puddle lights turn on when you unlock Model Y, when you open a door, and when you shift into Park. They turn off after a minute or two or when you shift into a driving gear or lock Model Y.

**Note:** The image below is provided for demonstration purposes only. Depending on vehicle options, software version and market region, your touchscreen may appear slightly different.

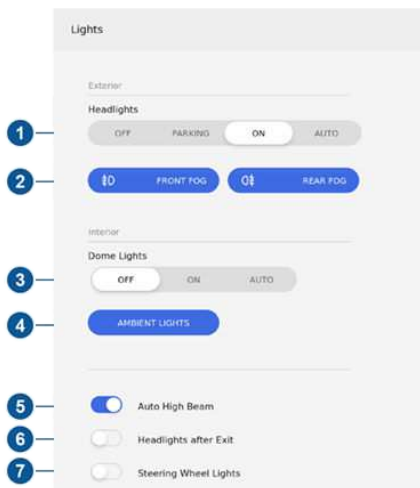

1. Exterior lights (headlights, tail lights, side marker lights, parking lights, and license plate lights) are set to **AUTO** each time you start Model Y. When set to **AUTO**, exterior lights automatically turn on when driving in low lighting conditions. If you change to a different setting, lights always revert to **AUTO** on your next drive.

Touch one of these options to temporarily change the exterior light setting:

- **OFF:** Exterior lights turn off until you manually turn them back on or until the next time you drive.
- **PARKING:** Only the exterior side marker lights, parking lights, tail lights and license plate lights turn on.

- **ON:** Exterior lights turn on.

**Note:** Any exterior lights (for example, daytime running lights) that are required to remain on in your market region will turn on as appropriate when driving, when parked on specific types of roads, etc.

**Note:** If equipped with the premium package, Model Y has a series of LED lights along the rim of the headlights, also referred to as "signature" lights. These lights automatically turn on whenever Model Y is powered on and a driving gear (Drive or Reverse) is engaged.

**⚠ Caution:** The rear tail lights are off while daytime running lights are on. Be sure the rear lights are on during low rear visibility conditions (for example, when it is dark, foggy, snowy, or the road is wet, etc.). Failure to do so can cause damage or serious injury.

**⚠ Warning:** Always ensure that your headlights are on during low visibility conditions. Failure to do so may result in a collision.

2. A separate control is available to turn on fog lights (if equipped). When on, fog lights operate whenever low beam headlights are on. When headlights are turned off, fog lights also turn off.
3. Turn the interior dome (map) lights on or off. If set to **AUTO**, all interior dome lights turn on when you unlock Model Y, open a door upon exiting, or shift into Park.

You can also manually turn an individual dome light on or off by pressing its lens. If you manually turn a dome light on, it turns off when Model Y powers off. If Model Y was already powered off when you manually turned the light on, it turns off after 60 minutes.





- If you turn on **AMBIENT LIGHTS**, interior ambient lights turn on whenever the headlights are on (if equipped with the premium package).  
**Note:** To control the backlighting on the steering wheel buttons, touch **Controls > Lights > Steering Wheel Lights**. If off, they do not turn on when headlights are on.
- If you turn on **Auto High Beam**, your vehicle automatically switches from high beam headlights to low beam headlights when light is detected in front of Model Y. See [High Beam Headlights](#) on page 61.
- If you turn on **Headlights after Exit**, the exterior lights remain on for a short period of time after you stop driving and park Model Y in low lighting conditions. See [Headlights After Exit](#) on page 62.
- If you turn on **Steering Wheel Lights**, the arrows associated with the scroll buttons are backlit in low ambient lighting conditions.

## Reading Lights

There are two reading lights in the second row seating area, both above the door and next to the coat hangers (see [Coat Hangers](#) on page 26). Turn an individual reading light on or off by pressing its lens. The reading light will automatically turn off when Model Y powers off.

## High Beam Headlights

Push the left-hand steering column lever away from you and release to turn the high beam headlights on continuously. To cancel, push the lever away from you again.

To briefly flash the high beam headlights, pull the lever towards you and release.







The high beam headlights can automatically switch to low beam when there is light detected in front of Model Y (for example, from an oncoming vehicle). To turn this feature on or off, touch **Controls > Lights > Auto High Beam**.

**Note:** Your chosen setting is retained until you manually change it.

In situations where **Auto High Beam** is turned on but the high beams are turned off because light is detected in front of Model Y, you can temporarily turn on the high beams by pulling the lever toward you.

The following indicator lights are visible on the touchscreen to show the status of the headlights:

-  Low beam headlights are on.
-  High beam headlights are on and Auto High Beam is disabled or currently unavailable.
-  Auto High Beam is enabled and high beams are on. Model Y is ready to turn off the high beams if light is detected.
-  Auto High Beam is enabled but high beams are not on because light is detected in front of Model Y. When light is no longer detected, high beams automatically turn back on.

**Warning:** Auto High Beam is an aid only and is subject to limitations. It is the driver's responsibility to make sure that the headlights are appropriately adjusted



for weather conditions and driving circumstances.

## Headlights After Exit

When **Headlights after Exit** is on, the exterior headlights remain on when you stop driving and park Model Y in low lighting conditions. They automatically turn off after one minute or when Model Y locks. When off, headlights turn off when you engage the Park gear and open a door.

To turn this feature on or off, touch **Controls > Lights > Headlights after Exit**.

## Headlight Adjustments

To adjust the angle of the headlights, touch **Controls > Service > Adjust Headlights**, then follow the onscreen instructions. You can choose which headlight you would like to adjust by selecting it on the touchscreen.

**Note:** Headlights do not require adjustments when temporarily driving into a region where the traffic direction is different (for example, driving in right-hand traffic region, and then driving into a region with left-hand traffic).

**Warning:** Proceed with caution when adjusting headlights. Tesla has carefully calibrated the position of the headlights to be in an optimum position for most driving scenarios. Tesla recommends that you do not adjust headlights unless you are familiar with how headlights should be adjusted. Once adjusted, you will be unable to automatically restore them to their originally calibrated position. Contact Tesla for assistance when adjusting headlights.

## Turn Signals

The turn signals flash three times or continuously, depending on how far up or down you move the lever. Lightly push the turn signal lever up or down for a three-flash sequence. For a continuous signal, push the lever fully up or down.



The turn signals stop operating when canceled by the steering wheel, by moving the lever in the opposite direction, or lightly pushing the lever in the same direction once more.



The corresponding turn signal indicator lights up on the touchscreen when a turn signal is operating. Model Y also emits a clicking sound.



**Warning:** If you have purchased an optional Autopilot package and Traffic-Aware Cruise Control is active, engaging a turn signal can cause Model Y to accelerate when using Traffic-Aware Cruise Control in specific situations (see [Overtake Acceleration](#) on page 89). If Autosteer is active on a vehicle with Auto Lane Change, engaging a turn signal may cause Model Y to change lanes.

## Hazard Warning Flashers

To turn on the hazard warning flashers, press the button located above the rear view mirror. All turn signals flash. Press the button again to turn off the hazard warning flashers.





**Note:** Hazard warning flashers operate even when Model Y cannot detect a key.

**Note:** The hazard warning light button is illuminated whenever Model Y is powered on.





## Overview

The touchscreen displays the status of Model Y at all times. What you see depends on whether the vehicle is:

- Parked (shown below).
- Driving (see [Driving Status](#) on page 65).
- Charging (see [Charging Status and Settings](#) on page 165).

When Model Y is parked, the status area shows the gear, estimated range, and an overhead view of the car with buttons you can touch to open the trunks and charge port door. When you press the brake, Model Y powers up and indicator lights flash briefly along the top. Unless an indicator light applies to the current situation (for example, a seat belt is not fastened), it should turn off. If an indicator light fails to turn on or off, contact Tesla.

**Note:** The following image is provided for demonstration purposes only. Depending on vehicle options, software version, and market region, the information displayed may be slightly different.

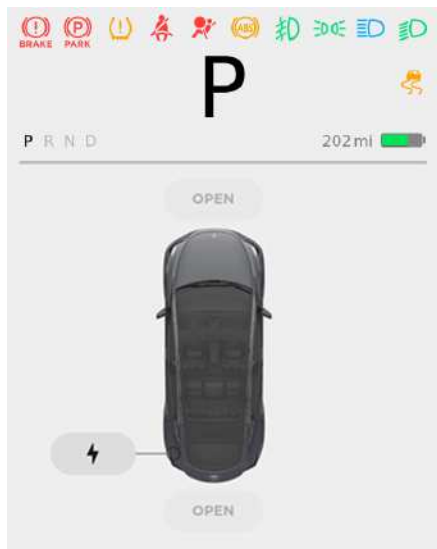

## Indicator Lights

The following indicator lights illuminate to advise you or alert you of a specific status or condition.



A brake system fault is detected or the brake fluid level is low. See [Braking and Stopping](#) on page 68. Contact Tesla immediately.



The parking brake is manually applied. See [Parking Brake](#) on page 70.



A parking brake fault is detected. Contact Tesla. See [Parking Brake](#) on page 70.



Tire pressure warning. The pressure of a tire is out of range. If a fault with the Tire Pressure Monitoring System (TPMS) is detected, the indicator flashes. View tire pressures in the "Cards" area, located below the touchscreen's car status area, as described in [Touchscreen Overview](#) on page 4. For a TPMS fault, contact Tesla. See [Tire Care and Maintenance](#) on page 170.



A seat belt for an occupied seat is not fastened. See [Seat Belts](#) on page 32.



Airbag safety. If this indicator does not flash on briefly when Model Y prepares to drive, or if it remains on, contact Tesla immediately. See [Airbag Warning Indicator](#) on page 49.



An ABS (Anti-lock Braking System) fault is detected. See [Braking and Stopping](#) on page 68. Contact Tesla immediately.



Front fog lights, if equipped. See [Lights](#) on page 60.



Parking lights (side marker lights, tail lights, and license plate lights) are on. See [Lights](#) on page 60.



Low beam headlights are on.



High beam headlights are on and Auto High Beam is disabled or currently unavailable.



Auto High Beam is enabled and high beams are on. Model Y is ready to turn off the high beams if light is detected. See [High Beam Headlights](#) on page 61.



Auto High Beam is enabled but high beams are not on because light is detected in front of Model Y. When light is no longer detected, high beams automatically turn back on. See [High Beam Headlights](#) on page 61.



This indicator flashes amber when the electronic stability control systems are actively minimizing wheel spin by controlling brake pressure and motor power. See [Traction Control](#) on page 72. If this indicator stays illuminated, a fault is detected (contact Tesla immediately).



Electronic stability control systems are no longer minimizing wheel spin. See [Traction Control](#) on page 72.



Vehicle Hold is actively applying the brakes. See [Vehicle Hold](#) on page 75.



A door or trunk is open. See [Doors](#) on page 14, [Rear Trunk](#) on page 18, or [Front Trunk](#) on page 20.



Appears when some of the stored energy in the Battery may not be available due to cold weather conditions. If Model Y is plugged in, you can heat your Battery by turning on climate control with the mobile app. The snowflake icon disappears when the Battery is sufficiently warm.



Vehicle power is currently being limited because the energy remaining in the Battery is low or the vehicle's systems are being heated or cooled (indicator light is amber).



Flashes green when the left turn signal is operating. Both turn signal indicators flash green when the hazard warning flashers are operating.



Flashes green when the right turn signal is operating. Both turn signal indicators flash green when the hazard warning flashers are operating.

## Driving Status

When Model Y is driving (or ready to drive), the touchscreen shows your current driving status and a real-time visualization of the road as detected by the Autopilot components (see [About Autopilot](#) on page 82). The visualization automatically zooms in and out to better utilize touchscreen space and inform you when a vehicle is detected in your blind spot.

**Note:** The following illustration is provided for demonstration purposes only. Depending on vehicle options, software version, and market region, the information displayed may be slightly different.

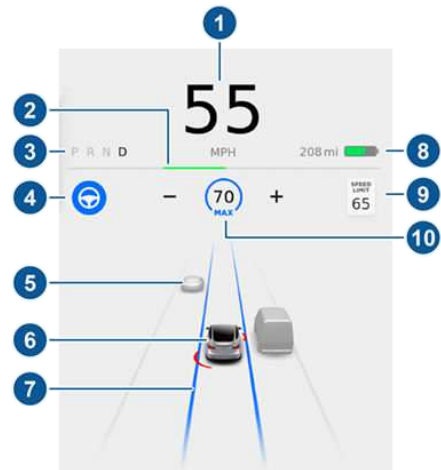

**Note:** Touch [Controls](#) > [Autopilot](#) > [Full Self-Driving Visualization Preview](#) to display more details about the roadway and its surroundings, such as road markings, stop signs, stop lights, objects (such as trash cans and poles), etc.

1. Driving speed.
2. On the energy bar, black (or white in night brightness) represents energy being used during acceleration and green indicates energy being gained through regenerative braking. A dashed line appears on the energy bar when power available for acceleration or power that can be gained by regenerative braking is being limited. Model Y limits power for many reasons. Here are just a few examples:

- Acceleration may be limited when the Battery is reaching a low state of charge or if the powertrain is hot.



- Both acceleration and regenerative braking may be limited when the ambient temperature is either very warm or cool.
  - Regenerative braking may be limited when the Battery is fully charged.
3. Currently selected gear: Park, Reverse, Neutral, or Drive.
  4. Autosteer (if equipped). When Autosteer is available but you haven't activated it, the icon is gray. When Autosteer is actively steering Model Y, the icon is blue.
  5. The car in front of you (if applicable).
  6. Your Model Y. Colored lines radiate from the image of your Model Y as objects are detected (other motorists, guard rails, etc.). The location of the lines correspond to the location of the detected object. The color of the lines (white, yellow, orange, or red) represents the object's proximity to Model Y, with white being the farthest and red being very close and requiring your immediate attention. See [Lane Assist](#) on page 110.
  7. When Autosteer is active (if equipped) and detecting the driving lane, the lane is highlighted in blue (see [Autosteer](#) on page 91).
  8. Total estimated driving distance (or energy) available. Instead of driving distance, you can display the percentage of battery energy remaining. To do so, touch **Controls** > **Display** > **Energy Display** > **Energy** (see [Controls](#) on page 118).

**Note:** When anticipating when you need to charge, use range estimates as a general guideline only.

9. The detected speed limit (see [Speed Assist](#) on page 116)
10. The set cruising speed. When Traffic-Aware Cruise Control (if equipped) is available but you haven't set a cruising speed, the icon is gray and the speed is not shown (see [Traffic-Aware Cruise Control](#) on page 85).

 **Warning:** Pay attention to important alert messages that display on the car status window. Ignoring these messages can result in serious injury or death.

 **Warning:** Although the touchscreen shows surrounding traffic, some vehicles may not be displayed. Never rely on the touchscreen to determine if a vehicle is present (for example, in your blind spot).

Always use your mirrors and perform shoulder checks.



## Wipers

To perform a single wipe with the windshield wipers, press and immediately release the button on the end of the left-hand steering column lever.

To adjust the continuous wiper settings, touch the windshield wiper icon located in the "Cards" area on the touchscreen (see [Touchscreen Overview](#) on page 4). The wiper card displays the current state of the wipers.

**Note:** When you operate the wipers, the headlights automatically turn on (if they were not on already).

**⚠ Caution:** To avoid damaging the hood, ensure that the hood is fully closed before activating the windshield wipers.



1. Turn the wipers on or off.
2. Adjust the speed of the wipers.
  - **1:** Intermittent, slow
  - **2:** Intermittent, fast
  - **3:** Continuous, slow
  - **4:** Continuous, fast
  - **AUTO:** Model Y detects whether or not it is raining. When wipers are set to AUTO and liquid is detected on the windshield, Model Y determines the optimal frequency at which they should wipe. If Model Y does not detect liquid on the windshield, the wipers do not wipe.

**Note:** The AUTO setting is currently in BETA. If uncertain about using AUTO while in the BETA phase, Tesla recommends setting the wiper speed to one of the first four positions, as necessary.

**Note:** If the AUTO setting is selected but becomes unavailable, the wipers change to the manual setting (one of the first four positions) that is closest to the latest determined AUTO wiping frequency. If the latest wiping frequency cannot be determined, the wipers turn off.

**⚠ Caution:** Ensure the wipers are off before washing Model Y to avoid the risk of damaging the wipers.

Periodically check and clean the edge of the wiper blades. If a blade is damaged, replace it immediately. For details on checking and replacing wiper blades, see [Wiper Blades and Washer Jets](#) on page 180.

**⚠ Caution:** Remove ice from the windshield before turning the wipers on. Ice has sharp edges that can damage the rubber on the blades.

**⚠ Caution:** In harsh climates, ensure that the wiper blades are not frozen or adhered to the windshield.

## Washers

Fully press and hold the button on the end of the left-hand steering column lever to spray washer fluid onto the windshield. While spraying the windshield, the wipers turn on. After releasing the button, the wipers perform two additional wipes, then a third wipe a few seconds later.



Periodically top up washer fluid (see [Topping Up Windshield Washer Fluid](#) on page 182).



## Braking Systems

**Warning:** Properly functioning braking systems are critical to ensure safety. If you experience a problem with the brake pedal, brake caliper, or any component of a Model Y braking system, contact Tesla immediately.

Model Y has an anti-lock braking system (ABS) that prevents the wheels from locking when you apply maximum brake pressure. This improves steering control during heavy braking in most road conditions.

During emergency braking conditions, the ABS constantly monitors the speed of each wheel and varies the brake pressure according to the grip available.

The alteration of brake pressure can be felt as a pulsing sensation through the brake pedal. This demonstrates that the ABS is operating and is not a cause for concern. Keep firm and steady pressure on the brake pedal while experiencing the pulsing.



The ABS indicator briefly flashes yellow on the touchscreen when you first start Model Y. If this indicator lights up at any other time, an ABS fault has occurred and the ABS is not operating. Contact Tesla. The braking system remains fully operational and is not affected by an ABS failure. However, braking distances may increase. Drive cautiously and avoid heavy braking.



If the touchscreen displays this red brake indicator at any time other than briefly when you first start Model Y, a brake system fault is detected, or the level of the brake fluid is low. Contact Tesla immediately. Apply steady pressure and keep the brakes firm to bring the vehicle to a stop when safe to do so.

## Emergency Braking

In an emergency, fully press the brake pedal and maintain firm pressure, even on low traction surfaces. The ABS varies the braking pressure to each wheel according to the amount of traction available. This prevents wheels from locking and ensures that you stop as safely as possible.

**Warning:** Do not pump the brake pedal. Doing so interrupts operation of the ABS and can increase braking distance.

**Warning:** Always maintain a safe distance from the vehicle in front of you and be aware of hazardous driving conditions. While the ABS can improve stopping distance, it cannot overcome the laws of physics. It also does not prevent the danger of hydroplaning (where a layer of water prevents direct contact between the tires and the road).

Automatic Emergency Braking is designed to automatically brake in situations where a collision is considered imminent (see [Automatic Emergency Braking](#) on page 114).

**Warning:** Automatic Emergency Braking is not designed to prevent a collision. At best, it can minimize the impact of a frontal collision by attempting to reduce your driving speed. Depending on Automatic Emergency Braking to avoid a collision can result in serious injury or death.

**Caution:** In emergency situations, if the brakes are not functioning properly, press and hold the Park button on the gear selector to bring the vehicle to a stop. Do not use this method to stop the vehicle unless absolutely necessary.

## Brake Disc Wiping

Model Y is equipped with brake disc wiping, which automatically assists in maintaining brake responsiveness in cold and wet weather conditions. When such conditions are detected, brake disc wiping repeatedly applies an imperceptible amount of brake force to clear away water on the brake disc surface. This ensures your brakes are responsive even during poor weather conditions.

## Hydraulic Fade Compensation

Your vehicle is also equipped with hydraulic fade compensation. This assists in monitoring brake system pressure and ABS activity for instances of lower brake performance. If lower brake performance is detected (as a result of brake fade, or cold or wet conditions, for example), you may feel the brake pedal pull away from your foot, detect some noise, and notice a strong increase in vehicle braking. Continue to press the brake pedal without releasing or "pumping" them— just brake as you normally would.



**⚠ Caution:** If the brakes are not functioning properly, stop the vehicle as soon as safety permits and contact Tesla Service. See [Park](#) on page 58 for information on using the Park button to stop the vehicle in case of emergency.

**⚠ Warning:** Always maintain a safe driving distance from the vehicle in front of you and be cautious in hazardous driving conditions. Do not rely on brake disc wiping or hydraulic fade compensation to act as a substitute for adequate braking.

## Regenerative Braking

Whenever Model Y is moving and your foot is off the accelerator, regenerative braking slows down Model Y and feeds any surplus energy back to the Battery.

By anticipating your stops and reducing or removing pressure from the accelerator pedal to slow down, you can take advantage of regenerative braking to increase driving range. Of course, this is no substitute for regular braking when needed for safety.

**Note:** If regenerative braking is aggressively slowing Model Y (such as when your foot is completely off the accelerator pedal at highway speeds), the brake lights turn on to alert others that you are slowing down.

**Note:** Installing winter tires with aggressive compound and tread design may result in temporarily-reduced regenerative braking power. However, your vehicle is designed to continuously recalibrate itself, and after changing tires it will increasingly restore regenerative braking power after some moderate-torque straight-line accelerations. For most drivers this occurs after a short period of normal driving, but drivers who normally accelerate lightly may need to use slightly harder accelerations while the recalibration is in progress.

**⚠ Warning:** In snowy or icy conditions Model Y may experience traction loss during regenerative braking, particularly when in the **Standard** setting and/or not using winter tires. Tesla recommends using the **Low** setting (see [To Set the Regenerative Braking Level](#) on page 69) in snowy or icy conditions to help maintain vehicle stability.

The amount of energy fed back to the Battery using regenerative braking can depend on the current state of the Battery and the charge level setting that you are using. For example, regenerative braking may be limited if the Battery is already fully charged or if the ambient temperature is too cold.

**Note:** If regenerative braking is limited, a dashed line displays on the energy bar (see [Driving Status](#) on page 65).

### To Set the Regenerative Braking Level

You can use the touchscreen to change the level of regenerative braking:

1. Touch **Controls > Driving > Regenerative Braking**.
2. Choose from two levels:
  - **Standard:** Provides the maximum amount of regenerative braking. When you release the accelerator, Model Y slows down, reducing the need to use the brakes.
  - **Low:** Limits regenerative braking. When you release the accelerator, Model Y takes longer to slow down and coasts further than if set to "Standard".

## Stopping Mode

Regenerative braking decelerates Model Y whenever you release the accelerator pedal when driving. You can choose what you want Model Y to do once the driving speed has been reduced to a very low speed (almost at a stop) and both the accelerator pedal and brake pedal are released. While in Park, touch **Controls > Driving > Stopping Mode** and choose from these options:



# Braking and Stopping

- **CREEP:** When close to, or at, a complete stop, the motor continues to apply torque, moving Model Y slowly forward (in Drive) or backward (in Reverse), similar to a conventional vehicle with an automatic transmission. In some situations, such as on a steep hill or driveway, you may need to press the accelerator pedal to continue moving or to prevent Model Y from moving in the opposite direction.

**Warning:** Never rely on CREEP to apply enough torque to prevent your vehicle from rolling down a hill. Always press the brake pedal to remain stopped or the accelerator pedal to proceed up the hill. Failure to do so can result in property damage and/or a collision.

- **HOLD:** Maximizes range and reduces brake wear by continuing to provide regenerative braking at speeds lower than with the Creep and Roll settings. When Model Y stops, the brakes are automatically applied without you having to put your foot on the brake pedal. Whether stopped on a flat surface or a hill, Vehicle Hold keeps the brake applied, provided your foot remains off the accelerator and brake pedals. See [Vehicle Hold](#) on page 75.

**Warning:** Never rely on HOLD to adequately decelerate or fully stop your vehicle. Many factors can contribute to a longer stopping distance, including downward slopes, the low regenerative braking setting, and reduced or limited regenerative braking (see [Regenerative Braking](#) on page 69). Always be prepared to use the brake pedal to adequately decelerate or stop.

- **ROLL:** When close to, or at, a complete stop, Model Y becomes free rolling like a vehicle in Neutral. Therefore, if stopped on a slope, Model Y will roll downward. The brake does not engage, and the motor does not apply torque (until the accelerator pedal is pressed).

**Note:** If you choose CREEP or ROLL, you can still use Vehicle Hold to apply the brakes. However, you will need to briefly press the brake pedal when the vehicle is stopped. See [Vehicle Hold](#) on page 75.

- **Warning:** Press the brake pedal if Model Y moves when unsafe to do so. It is your responsibility to stay alert and be in control of the vehicle at all times. Failure

to do so can result in serious damage, injury, or death.

**Warning:** Do not rely on regenerative braking and your chosen Stopping Mode to keep you and your vehicle safe. Various factors such as driving with a heavy vehicle load, on a steep hill, or on wet or icy roads affect deceleration rate and the distance at which Model Y will come to a stop. Drive attentively and always stay prepared to use the brake pedal to stop as appropriate based on traffic and road conditions.

**Warning:** Forward Collision Warning and Automatic Emergency Braking do not operate when driving at very low speeds (see [Collision Avoidance Assist](#) on page 113). Do not rely on these features to warn you, or to prevent or reduce the impact of a collision.

**Note:** Your chosen setting is retained in your Driver Profile until you manually change it.

## Parking Brake

The parking brake automatically engages when you shift Model Y into Park, and releases when you shift into any other gear.



**Note:** The parking brake operates on the rear wheels only, and is independent of the pedal-operated brake system.

**Warning:** In snowy or icy conditions the rear wheels may not have sufficient traction to prevent Model Y from sliding down a slope, particularly if not using winter tires. Avoid parking on hills in snowy or icy conditions. You are always responsible for parking safely.

**Warning:** Your Model Y may display an alert if the road is too steep to safely park on, or if the parking brakes are not properly engaged. These alerts are for guidance purposes only and are not a substitute for the driver's judgment of safe parking conditions, including specific road or weather conditions. Do not depend on these alerts to determine whether or not it is safe to park at any



location. You are always responsible for parking safely.



When you use the touchscreen to manually apply the parking brake, the red parking brake indicator lights up on the touchscreen.



If the parking brake experiences an electrical issue, the amber parking brake indicator lights up and a fault message displays at the top of the touchscreen.



**Caution:** In the unlikely event that Model Y loses electrical power, you cannot access the touchscreen and are therefore unable to release the parking brake without first jump starting Model Y (see [Instructions for Transporters](#) on page 203).

## Brake Wear

Model Y brake pads are equipped with wear indicators. A wear indicator is a thin metal strip attached to the brake pad that squeals as it rubs against the rotor when the pad wears down. This squealing sound indicates that the brake pads have reached the end of their service life and require replacement. To replace the brake pads, contact Tesla Service.

Brakes must be periodically inspected visually by removing the tire and wheel. For detailed specifications and service limits for rotors and brake pads, see [Subsystems](#) on page 190. Additionally, Tesla recommends cleaning and lubricating the brake calipers every year or 12,500 miles (20,000 km) if in an area where roads are salted during winter months.



**Warning:** Neglecting to replace worn brake pads damages the braking system and can result in a braking hazard.





## How It Works

The traction control system constantly monitors the speed of the front and rear wheels. If Model Y experiences a loss of traction, the system minimizes wheel spin by controlling brake pressure and motor power. By default, the traction control system is on. Under normal conditions, it should remain on to ensure maximum safety.



This yellow indicator flashes on the touchscreen whenever the traction control system is actively controlling brake pressure and motor power to minimize wheel spin. If the indicator stays on, a fault is detected with the traction control system. Contact Tesla Service.

**Warning:** Traction control cannot prevent collisions caused by driving dangerously or turning too sharply at high speeds.

## Disabling Traction Control

Under normal conditions, the traction control system should remain on. Turn it off only in circumstances where you deliberately want the wheels to spin, such as:

- Starting on a loose surface, such as gravel or snow.
- Driving in deep snow, sand or mud.
- Rocking out of a hole or deep rut.
- Driving off-road.

To turn off traction control and allow the wheels to spin, touch **Controls > Driving** and choose one of these options, depending on the circumstances:

- **Slip Start** is designed to make it easier to dislodge Model Y when stuck in mud, snow, ice, etc. Turning on Slip Start allows the wheels to spin, making it possible to rock Model Y out of a situation in which the wheels are stuck.

- **Off-Road Assist** is designed to provide overall improvements when driving off-road. In addition to allowing the wheels to spin, Off-Road Assist balances the torque between the front and rear motors to optimize traction. Off-Road Assist improves traction on rough and soft surfaces where one side of the vehicle may lose traction while the other side still has traction. When Off-Road Assist is on, the accelerator pedal provides more gradual torque, which is useful for crawling at low speeds (for example, over rocky surfaces). When enabled, **OFF-ROAD** displays on the touchscreen above the driving speed.

After the circumstances that required you to turn on Slip Start or Off-Road Assist have passed, it is strongly recommended that you turn the setting off to re-enable traction control. If you leave these settings on, Traction Control automatically re-enables on your next drive.



When you turn on Slip Start or Off-Road Assist, the touchscreen displays an indicator light to indicate that the traction control system is no longer preventing wheel slip.

**Note:** Although you can use Slip Start and Off-Road Assist at any speed, it is less effective at higher speeds.

**Note:** Slip Start and Off-Road Assist are not available when you are using Traffic-Aware Cruise Control.

**Note:** Engaging cruise control when Slip Start or Off-Road Assist is on causes the feature to turn off and traction control to be re-enabled.

**Note:** Automatic Emergency Braking and Lane Departure Avoidance do not operate when Off-Road Assist is turned on.



## How Park Assist Works

Model Y has several sensors designed to detect the presence of objects. When driving slowly in Drive or Reverse (for example, when parking), the sensors alert you if an object is detected in close proximity of your Model Y. Objects are only detected in the direction of the gear you selected; front objects in Drive, rear objects in Reverse.

**Warning:** You may not be alerted if Model Y rolls freely in the opposite direction of the gear you selected (for example, you will not receive an alert if Model Y rolls backwards down a hill while in Drive).



The sensors are activated when driving slower than 5 mph (8 km/h).

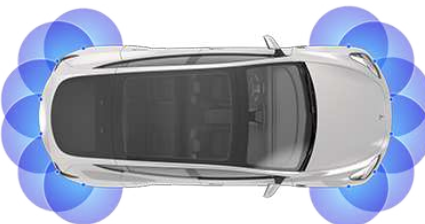

**Warning:** Never depend on Park Assist to inform you if an area you are approaching is free of objects and/or people. Several external factors can reduce the performance of Park Assist, causing either no readings or false readings (see [Limitations and False Warnings](#) on page 74). Therefore, depending on Park Assist to determine if Model Y is approaching an obstruction can result in damage to the vehicle and/or objects, and can potentially cause serious injury. Always inspect the area with your own eyes. When reversing, perform shoulder checks and use all mirrors. Park assist does not detect children, pedestrians, bicyclists, animals, or objects that are moving, protruding, located too far above or below the sensors, or too close or too far from the sensors. Park Assist is for guidance purposes only and is not intended to replace your own direct visual checks. It is not a substitute for careful driving.

## Visual and Audio Feedback

When you shift to Reverse, the Park Assist view displays on the touchscreen, showing objects that are in close proximity to the front and rear of Model Y. This view closes when you shift into Drive unless an object is detected close to the front of Model Y, in which case the Park Assist view closes automatically when your driving speed exceeds 5 mph (8 km/h). When reversing, visual feedback also displays on the touchscreen, immediately below the camera view (see [Rear View Camera](#) on page 77). You can manually close the park assist view on the touchscreen by touching the **X** in the upper corner.

When driving with the Camera app displayed on the touchscreen, you can switch to the Park Assist view when driving at speeds below 5 mph (8 km/h). Touch the button located in the upper left corner of the Camera app window. This is useful if you need assistance with parallel parking.



If chimes are turned on (see [Controlling Audible Feedback](#) on page 74), an audible beep sounds as you approach an object. You can temporarily mute the chime by pressing the scroll button on the left side of the steering wheel or by touching the mute button on the bottom left corner of the Park Assist view.

**Note:** If a sensor is unable to provide feedback, the touchscreen displays an alert message.

**⚠ Caution:** Keep sensors clean from dirt, debris, snow, and ice. Avoid using a high pressure power washer on the sensors and do not clean a sensor with a sharp or abrasive object that can scratch or damage its surface.

**⚠ Caution:** Do not install accessories or stickers on or near the parking sensors.

## Controlling Audible Feedback

You can use Park Assist with or without audible feedback. To turn chimes on or off, touch **Controls > Safety & Security > Park Assist Chimes**.

To mute the chimes temporarily, press the scroll button on the left side of the steering wheel or touch the mute button in the corner of the Park Assist view. The chimes are muted until you shift into a different gear or drive over 5 mph (8 km/h).

## Limitations and False Warnings

The parking sensors may not function correctly in these situations:

- One or more of the parking sensors is damaged, dirty, or covered (such as mud, ice, or snow).
- The object is located below approximately 8 inches (20 cm) (such as a curb or low barrier).

**⚠ Caution:** Shorter objects that are detected (such as curbs or low barriers) can move into the blind spot of the sensors. Model Y cannot alert you about an object while it is in the blind spot of the sensors.

- Weather conditions (heavy rain, snow, or fog) are interfering with sensor operation.
- The object is thin (such as a sign post).
- A sensor's operating range has been exceeded.

- The object is sound-absorbing or soft (such as powder snow).
- The object is sloped (such as a sloped embankment).
- Model Y has been parked in, or being driven in, extremely hot or cold temperatures.
- The sensors are affected by other electrical equipment or devices that generate ultrasonic waves.
- You are driving in a location where the sensors' ultrasonic waves are deflected away from the vehicle (such as driving next to a wall or pillar).
- The object is located too close to the bumper.
- A bumper is misaligned or damaged.
- An object that is mounted to Model Y is interfering with and/or obstructing the sensor (such as a bike rack or bumper sticker).
- Model Y rolls freely in the opposite direction of the gear you selected (for example, you will not receive an alert if Model Y rolls backwards down a hill while in Drive).

## Other Parking Aids

In addition to Park Assist, when shifted into Reverse, the backup camera displays a view of the area behind Model Y (see [Rear View Camera](#) on page 77).



When Model Y is stopped, Vehicle Hold can continue to apply the brakes even after you remove your foot from the brake pedal. When driving on a hill or on a flat surface, brake as you normally would. After coming to a complete stop, simply press the brake pedal again (until the touchscreen displays the Vehicle Hold indicator light) to enable Vehicle Hold. You can then release the brake pedal and remain stopped, even on a hill.



This indicator displays on the touchscreen whenever Vehicle Hold is actively braking Model Y.

To disengage Vehicle Hold, press the accelerator pedal or press and release the brake pedal.

**Note:** Shifting into Neutral also disengages Vehicle Hold.

**Note:** After actively braking Model Y for approximately ten minutes, Model Y shifts into Park and Vehicle Hold cancels. Model Y also shifts into Park if it detects that the driver has left the vehicle.

**Note:** When Stopping Mode is set to Hold (see [Stopping Mode](#) on page 69), Vehicle Hold engages automatically whenever Model Y stops while in a driving gear. There is no need to press the brake to engage it.



## Driving Tips to Maximize Range

You can maximize your driving range using the same driving habits that you use to conserve fuel in a gasoline-powered vehicle. In addition to driving habits, energy consumption depends on environmental conditions (such as exceptionally cold or hot weather and driving on roads with steep hills). To get the maximum range from a charge:

- Slow down your driving and avoid frequent and rapid acceleration.
- If safe to do so, modulate the accelerator pedal instead of using the brake pedal when gradually slowing down. Whenever Model Y is moving and you are not pressing the accelerator pedal, regenerative braking slows down Model Y and feeds surplus energy back to the Battery (see [Regenerative Braking](#) on page 69).
- Set Stopping Mode to **HOLD** to gain the benefit of regenerative braking at low driving speeds (see [Stopping Mode](#) on page 69).
- Keep tires at the recommended inflation pressures (see [Tire Care and Maintenance](#) on page 170).
- Lighten your load by removing any unnecessary cargo.
- Fully raise all windows.
- Limit the use of resources such as heating, lights, and air conditioning. Using seat heaters to keep warm is more efficient than heating the cabin.

The power meter on the touchscreen and the Energy app provides feedback on energy usage. With this feedback, you can become familiar with how driving habits and environmental conditions impact how much energy Model Y is using.

## Energy App

Use the Energy app to view real-time and projected energy usage. Choose from two types of charts:

- **Consumption:** display how much energy Model Y has consumed over the past 5, 15 or 30 miles (10, 25 or 50 km).

Touch **Instant Range** or **Average Range** to adjust the projected range estimation. Instant Range uses only the latest few data points to estimate the projected range, whereas Average Range uses the past 5, 15 or 30 miles (10, 25 or 50 km) of energy consumption to provide a more accurate projected range.

- **Trip:** monitor the amount of energy being used while navigating to a destination. You can track actual usage against the initial prediction. The green line represents the actual usage whereas the gray line represents predicted usage. To change the zoom level, touch the zoom icon located in the top right corner of the chart.

**Note:** The Trip chart displays energy usage only if you are currently navigating to a destination.

## Range Assurance

Model Y helps protect you against running out of energy. Model Y continuously monitors its energy level and proximity to known charging locations.



Touch the map's charging icon to toggle between displaying superchargers only, and displaying all chargers, including destination chargers, and visited chargers.

When you are at risk of driving beyond the range of known charging locations, the touchscreen displays a message giving you the opportunity to display a list of charging locations that are within range. When you select a charging location from the list, Model Y provides navigation instructions and the turn-by-turn direction list displays the predicted amount of energy that will remain when you arrive at the charging destination.



## Camera Location

Model Y is equipped with a rear view camera located above the rear license plate.



Whenever you shift into Reverse, the touchscreen displays the view from the camera. Lines show your driving path based on the position of the steering wheel. These lines adjust appropriately as you move the steering wheel.

**Note:** Visual feedback from the parking sensors display on the touchscreen (see [Park Assist](#) on page 73).

To display the view from the camera at any time:



Touch the camera icon on the "Cards" area on the touchscreen.

**Warning:** Never depend on the rear view camera to inform you if the area behind you is free of objects and/or people when reversing. The camera may not detect objects or barriers that can potentially cause damage or injury. In addition, several external factors can reduce the performance of the camera, including a dirty or obstructed lens. Therefore, depending on the rear view camera to determine if Model Y is approaching an obstruction can result in damage to the vehicle and/or objects, and can potentially cause serious injury. Always inspect the area with your own eyes. When reversing, perform shoulder checks

and use all mirrors. Use the camera for guidance purposes only. It is not intended to replace your own direct visual checks and is not a substitute for careful driving.

## Cleaning the Camera

To ensure a clear picture, keep the camera lens clean, and free of obstructions. Remove any buildup of dirt by occasionally wiping the camera lens with a soft damp cloth.

**Caution:** Do not use chemical-based or abrasive cleaners. Doing so can damage the surface of the camera lens.



## About Dashcam

**Note:** Dashcam is a BETA feature.

In addition to supporting Autopilot features, the cameras can record and store video footage on a USB flash drive. This can be convenient in situations where you want a video recording of a particular incident, such as a collision. You can pause, resume, or save video recordings directly from your vehicle's touchscreen.

**Note:** Dashcam only works when Model Y is powered on (see [Starting and Powering Off](#) on page 56). Dashcam does not record video when your vehicle is powered off.

## Using Dashcam

Dashcam requires the use of a properly formatted USB flash drive to store and retrieve footage (see [USB Flash Drive Requirements for Videos and Recording](#) on page 146). Once a properly formatted USB flash drive has been inserted into one of your vehicle's front USB ports, a dashcam icon appears at the top of the touchscreen. Touch the dashcam icon to control dashcam:



**RECORDING.** Tap the dashcam icon, when dashcam is paused, to start recording video on the flash drive.



**PAUSED.** Press and hold the dashcam icon, when recording, to pause recording. Ensure that dashcam is paused before removing the flash drive to avoid losing camera footage.



**SAVED.** Tap the dashcam icon, when recording, to archive the most recent ten minutes of video. These saved video recordings are not overwritten by new recordings.

**Note:** Dashcam automatically begins recording when you insert a properly configured USB flash drive into one of the front USB ports.

## USB Flash Drive Requirements for Videos and Recording

To store video from your vehicle's cameras, follow these requirements and guidelines for using flash drives:

- The flash drive must have a sustained write speed of at least 4 MB/s. A sustained write speed is different from the peak write speed. Check the product details of your flash drive for more information.
- The flash drive must be USB 2.0 compatible. If using a USB 3.0 flash drive, it must be able to support USB 2.0.
- Use a dedicated flash drive exclusively for saving Sentry Mode recordings.
- The flash drive must be properly formatted (see [Formatting the USB Flash Drive](#) on page 147).
- Use a flash drive with as much available storage as possible. Video footage can occupy a large amount of space. Tesla recommends using a flash drive with at least 32 GB of storage. Some personal computer operating systems may be unable to format flash drives larger than 32 GB as FAT 32. Consider using a third party application to format flash drives larger than 32 GB.

Although not a comprehensive list, Tesla has testing the following flash drives and confirmed that they meet the requirements for using Dashcam and Sentry Mode:

- SanDisk Ultra Fit USB 3.1 Flash Drive
- Samsung MUF-64AB/AM FIT Plus - 200MB/s USB 3.1 Flash Drive

## Formatting the USB Flash Drive

To correctly save and retrieve video footage, Model Y requires the USB flash drive to be formatted as FAT 32 (for Windows), MS-DOS FAT (for Mac), ext3, or ext4. NTFS and exFAT are not currently supported. In addition, the USB flash drive must contain a base-level folder called "TeslaCam" (without quotation marks). Follow the steps below to prepare a USB flash drive.

### For MacOS:

1. Insert the USB flash drive into your personal computer.
2. Navigate to **Utilities > Disk Utility** (or conduct a Spotlight Search).
3. Select your flash drive in the left menu.
4. Navigate to **Erase** in the top menu ribbon.



- In the pop-up menu, select the correct format (MS-DOS FAT) and click **Erase**.

**Note:** Selecting **Erase** removes all existing content from your flash drive. If you have content that you want to keep, you must move it to a different device before erasing.

- Once the flash drive is successfully erased, navigate to **Finder** and select your USB flash drive from the left menu. The flash drive should not contain any files.
- Right-click in the empty space of the flash drive and select **New Folder**. A folder appears in your flash drive space.
- Right-click on the folder, select **Rename**, and name the folder to “**TeslaCam**” (without quotation marks). Click “**Save**”. This folder will contain all recent and saved clips from Sentry Mode and dashcam.
- Properly eject the USB flash drive.

#### For Windows:

- Insert the USB flash drive into your personal computer.
  - Navigate to **File Explorer**.
  - Right-click on your USB flash drive and select “**Format...**”.
  - In the pop-up menu, under the File System section, select “**FAT 32**”.
- Note:** You can also name your USB flash drive (under Volume Label) for easier recognition.
- Check the **Quick format** box and click **Start**.
  - Go back to File Explorer, click on your flash drive, and right-click to create a folder, or select **New Folder** in the top menu.
  - Name the folder “**TeslaCam**” (without quotation marks) and click **Save**. This folder will contain all recent and saved clips from Sentry Mode and dashcam.
  - Properly eject the USB flash drive.

Once you have formatted the USB flash drive and created the **TeslaCam** folder, insert it into one of the front USB ports in Model Y. Do not use the rear USB ports—they are for charging only. It may take Model Y up to 15 seconds to recognize the flash drive. When recognized, icons for dashcam and Sentry Mode appear at the top of your touchscreen (note that you may need to enable Sentry Mode by touching **Controls > Safety & Security > Sentry Mode**). Model Y is ready to record video.

#### Retrieving Footage

To retrieve video footage from the USB flash drive, remove the flash drive from the front USB port and use a personal computer or other device to access the files. Navigate to the **TeslaCam** folder.

Within the **TeslaCam** folder, there are three sub-folders:

- Recent Clips - The footage in Recent Clips continuously loops in 60-minute cycles whenever the cameras are activate. Therefore, footage is constantly overwritten every hour unless you save it. When an event is recorded, one video is recorded for each of the front, rear, left, and right cameras.
- Saved Clips - Contains all recordings that you have manually saved using [Dashcam](#) on page 78.
- Sentry Clips - Contains all footage from Sentry Mode events which have been automatically saved when an Alert or Alarm state is triggered. The last 10 minutes of an event's footage is saved and labeled with a unique timestamp.

**Note:** As the USB flash drive runs out of available space, the oldest footage in Sentry Clips is deleted to make room for new footage. Once deleted, you will be unable to retrieve them. When the flash drive is full, Sentry Mode and Dashcam can no longer save video footage. To prevent the flash drive from getting full, you must regularly move saved videos to another device, and delete them from the flash drive.

**Note:** You are responsible for complying with all local laws, regulations, and property restrictions regarding video recordings.

**Note:** The cameras do not record audio.

#### Save Clips on Honk

Once a properly formatted USB flash drive is inserted in one of the vehicle's front USB ports, you can choose to save dashcam clips while driving when you honk the horn on your steering wheel. Navigate to **Controls > Safety and Security > Save Clips on Honk > ON** to enable. The most recent ten minutes of footage is saved. You can also save dashcam footage by touching the dashcam icon at the top of the touchscreen.





The following best practices can help ensure that you have the best ownership experience possible in harsh cold weather conditions.

## Before Driving

Warm the cabin and Battery ahead of departure for maximum range and performance. There are several ways to precondition your vehicle:

- **Mobile app preconditioning:** On the mobile app, navigate to **Climate > Turn On** and customize the temperature at which you want to heat the cabin, which also warms the Battery as needed (see [Mobile App](#) on page 155).
  - **Mobile app defrost:** On the mobile app, navigate to **Climate > Defrost** to melt snow, ice, and frost on the windshields, driver and passenger windows, mirrors, and charge port. The Battery will also warm as needed.
- Note:** Tesla recommends activating the climate settings at least 30-45 minutes before departure (see [Climate Controls](#) on page 127). Preconditioning times depend on outside temperature and other factors.
- **Scheduled Departure:** Use to preset a time at which you want your vehicle to be ready to drive (see [Scheduled Charging and Scheduled Departure](#) on page 167).

When snow and ice accumulate on your vehicle, moving parts, such as the door handles, windows, mirrors, and wipers can freeze in place.

## Door Handles

- If the door handles are frozen in place, you can remove the ice by firmly pressing the innermost portion of the door handle.

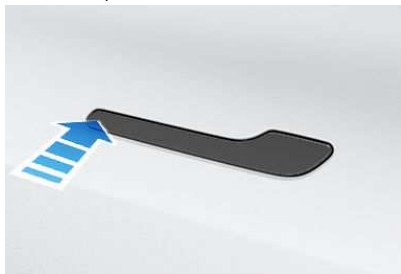

## Windows

- On the mobile app, navigate to **Climate > Defrost** as mentioned previously. Your vehicle heats the driver and passenger windows to help melt any ice that would prevent the windows from moving.
- Model Y automatically adjusts the window positioning slightly to make it easier to open the doors when ambient temperatures are cold.
- Use the mobile app to schedule a service appointment where Tesla can provide hydrophobic coating to your windows for a nominal fee.

## Mirrors

If ice buildup is expected when parking, turn off **Auto-Fold Mirrors** by navigating to **Controls > Mirrors > Auto-Fold > ON**. Ice can prevent exterior side mirrors from folding or unfolding.

**Note:** The side mirrors automatically heat as needed during preconditioning or if the rear defroster is activated.

## Wipers

If snow or ice buildup is expected when parking, navigate to **Controls > Service > Wiper Service Mode > ON**. This raises your wipers so they are against the windshield and they can defrost while the windshield defrosts (see [Wipers and Washers](#) on page 67).

## Winter Tires and Tire Chains

- Use winter tires to increase traction in snowy or icy conditions. You can purchase winter tires on <http://www.tesla.com> (see [Seasonal Tire Types](#) on page 176).
- Tire chains provide additional traction when driving in snowy or icy conditions. Check your local regulations to see if tire chains are recommended or required during winter months. See [Using Tire Chains](#) on page 176 for more information.

## While Driving

Cold weather can increase energy consumption because more power is required for driving, cabin and Battery heating. Follow these suggestions to reduce energy consumption:



- Using the seat heaters to keep warm is more efficient than using climate controls. Lowering the cabin temperature and using seat heaters will reduce energy consumption (see [Climate Controls](#) on page 127).
- Slow down your driving and avoid frequent and rapid acceleration.

### Regenerative Braking

Regenerative braking may be limited if the Battery is too cold. As you continue to drive, the Battery warms up and regenerative power increases (see [Regenerative Braking](#) on page 69).

**Note:** Limited regenerative braking can be avoided if you allow enough time to precondition your vehicle or use scheduled departure before your drive, as mentioned previously.

**Note:** Installing winter tires may result in temporarily reduced regenerative braking power but Model Y will recalibrate itself to correct this after a short period of driving.

### Blue Snowflake Icon



A blue snowflake icon appears on your touchscreen when some of the stored energy in the Battery may not be available due to cold Battery temperature. This portion of unavailable energy displays in blue on the Battery meter. Regenerative braking, acceleration, and charging rates may be limited. The snowflake icon no longer displays when the Battery is sufficiently warmed.

### Warming the Battery Before Supercharging

If you are using Trip Planner (see [Trip Planner](#) on page 136) and navigate to a Supercharger station, your vehicle will allocate energy to pre-heat the Battery in cold weather. This ensures you arrive at the Supercharger with an optimal Battery temperature, reducing the amount of time it takes to charge.

### Autopilot

To ensure optimal Autopilot performance, keep the sensors and radar free of snow, ice, mud, and dirt (see [About Autopilot](#) on page 82).

### After Driving

Leave Model Y plugged in when not in use. This uses the charging system, rather than the Battery itself, to keep your Battery warm (see [Battery Information](#) on page 160).

### Scheduled Departure

When parked, plug in Model Y and set a time at which you want your vehicle to be ready to drive. Your vehicle determines the appropriate time to begin charging so that charging is complete and the cabin and Battery are warm by your set departure time. See [Scheduled Charging and Scheduled Departure](#) on page 167 for more information.

### Charge Port

- If your charge port latch freezes in place and a charging cable becomes stuck in the charge port, try manually releasing the charge cable. See [Manually Releasing Charge Cable](#) on page 163.
- Use the mobile app to precondition your vehicle on **HI** to help thaw ice on the charge port latch so that the charge cable can be removed or inserted (see [Mobile App](#) on page 155).

**Note:** If your charge port latch is frozen in place, it may not lock the charging cable in place when inserted, but it is still able to AC charge at a slower rate even if the latch is not engaged.

### Storage

If you leave Model Y parked for an extended period of time, plug it into a charger to prevent normal range loss and maintain the Battery at an optimal temperature. Your vehicle is safe to say plugged in for any length of time.

When not in use, Model Y automatically enters a sleep mode to conserve range and energy. Reduce the number of times you check your vehicle's status on the mobile app, as this automatically wakes up your vehicle and starts normal energy consumption.

**Note:** See [Wipers](#) on page 80 and [Mirrors](#) on page 80 for more information on preventing ice buildup when parking your vehicle.



## How It Works

Your Model Y includes the following Autopilot components that actively monitor the surrounding roadway:

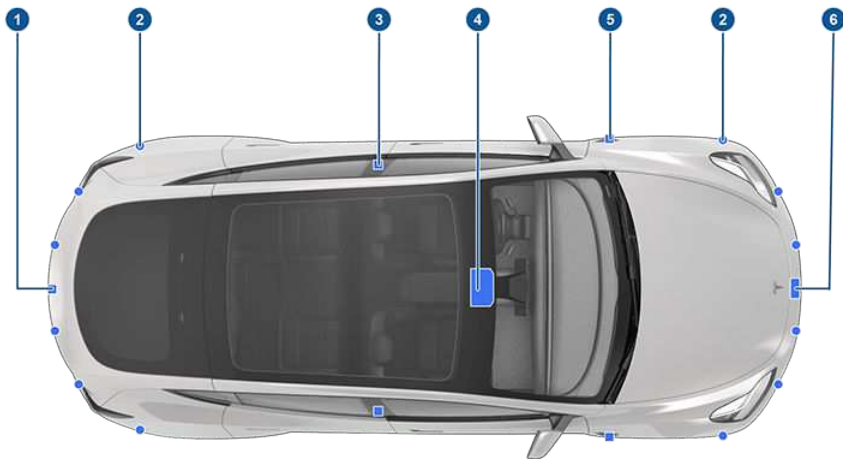

1. A camera is mounted above the rear license plate.
2. Ultrasonic sensors are located in the front and rear bumpers.
3. A camera is mounted in each door pillar.
4. Three cameras are mounted to the windshield above the rear view mirror.
5. A camera is mounted to each front fender.
6. Radar is mounted behind the front bumper.

Model Y is also equipped with high precision electronically-assisted braking and steering systems.

**Note:** Ensure all cameras and sensors are clean before each drive. See [Cleaning Cameras and Sensors](#) on page 84 for more information. Unclean cameras and sensors, as well as environmental conditions such as rain and faded lane markings, can affect Autopilot performance.



## Features

These safety features are available on all Model Y vehicles:

- Lane Assist (see [Lane Assist](#) on page 110).
- Collision Avoidance Assist (see [Collision Avoidance Assist](#) on page 113).
- Speed Assist (see [Speed Assist](#) on page 116).
- Auto High Beam (see [High Beam Headlights](#) on page 61).

These Autopilot convenience features are designed to reduce driver workload:

- Traffic-Aware Cruise Control (see [Traffic-Aware Cruise Control](#) on page 85)
- Autosteer (see [Autosteer](#) on page 91)
- Auto Lane Change (see [Auto Lane Change](#) on page 93)
- Autopark (see [Autopark](#) on page 101)
- Summon (see [Summon](#) on page 103)
- Smart Summon ([Smart Summon](#) on page 106)
- Navigate on Autopilot (see [Navigate on Autopilot](#) on page 94)
- Stop Light and Stop Sign Warning (see [Stop Light and Stop Sign Warning \(U.S. only\)](#) on page 94)

**Note:** Depending on market region, options purchased, and software version, your vehicle may not be equipped with all Autopilot features.

You can enable/disable some of these features and in some cases, control how they work. To access settings, touch **Controls** > **Autopilot**.

## Drive to Calibrate Cameras

Model Y must maneuver with a great deal of precision when Autopilot features are being used. Therefore, before some features (for example, Traffic-Aware Cruise Control or Autosteer) can be used for the first time or after certain Service repairs, the cameras must complete a self-calibration process. For your convenience, a progress indicator is displayed on the touchscreen.

Calibration typically completes after driving 20-25 miles (32-40 km), but the distance varies depending on road and environmental conditions. Driving on a straight road with highly-visible lane lines allows Model Y to calibrate quicker. When calibration is complete, the Autopilot features are available for use. Contact Tesla only if your Model Y has not completed the calibration process after driving 100 miles (160 km).

**Note:** If you attempt to use a feature that is not available until the calibration process is complete, the feature will not be enabled and the touchscreen displays a message.

**Note:** Model Y must repeat the calibration process if the cameras are serviced by Tesla, and in some cases, after a software update.

## Limitations

Many factors can impact the performance of Autopilot components, causing them to be unable to function as intended. These include (but are not limited to):

- Poor visibility (due to heavy rain, snow, fog, etc.).
- Bright light (due to oncoming headlights, direct sunlight, etc.).
- Damage or obstructions caused by mud, ice, snow, etc.
- Interference or obstruction by object(s) mounted onto the vehicle (such as a bike rack).
- Obstruction caused by applying excessive paint or adhesive products (such as wraps, stickers, rubber coating, etc.) onto the vehicle.
- Narrow or winding roads.
- A damaged or misaligned bumper.
- Interference from other equipment that generates ultrasonic waves.
- Extremely hot or cold temperatures.

**Warning:** The list above does not represent an exhaustive list of situations that may interfere with proper operation of Autopilot components. Never depend on these components to keep you safe. It is the driver's responsibility to stay alert, drive safely, and be in control of the vehicle at all times.

**Caution:** If a windshield replacement is needed, take your vehicle to Tesla Service. This will ensure appropriate handling and mounting of the camera(s). Failure to do





so can cause one or more Autopilot features to malfunction.

## Cleaning Cameras and Sensors

To ensure the various Autopilot components can provide information that is as accurate as possible, keep them clean and free of obstructions, condensation, or damage. Occasionally remove any buildup of dirt by wiping the components with a soft cloth dampened with warm water.

Condensation can form inside the camera enclosures, especially if you park your vehicle outside in cold or wet conditions. The touchscreen may display an alert stating that a camera is blocked and that some or all Autopilot features may be temporarily restricted until the camera vision is clear. To proactively dry the condensation, precondition the cabin by setting it to a warm temperature, turning the windshield defroster on, and directing the front air vents toward the door pillars (see [Mobile App](#) on page 155).

-  **Caution:** Do not use chemical-based or abrasive cleaners. Doing so can damage surfaces.
-  **Caution:** Avoid using a high-pressure power washer.
-  **Caution:** Do not clean an ultrasonic sensor or camera lens with a sharp or abrasive object that can scratch or damage its surface.



**Note:** Traffic-Aware Cruise Control is a BETA feature.

Traffic-Aware Cruise Control uses the forward looking cameras and the radar sensor to determine when there is a vehicle in front of you in the same lane. If the area in front of Model Y is clear, Traffic-Aware Cruise Control maintains a set driving speed. When a vehicle is detected, Traffic-Aware Cruise Control is designed to slow down Model Y as needed to maintain a selected time-based distance from the vehicle in front, up to the set speed. Traffic-Aware Cruise Control does not eliminate the need to watch the road in front of you and to manually apply the brakes when needed.

Traffic-Aware Cruise Control is primarily intended for driving on dry, straight roads, such as highways and freeways. It should not be used on city streets.

- ⚠ **Caution:** Ensure all cameras and sensors are clean before each drive. Unclean cameras and sensors, as well as environmental conditions such as rain and faded lane markings, can affect Autopilot performance.
- ⚠ **Warning:** Traffic-Aware Cruise Control is designed for your driving comfort and convenience and is not a collision warning or avoidance system. It is your responsibility to stay alert, drive safely, and be in control of the vehicle at all times. Never depend on Traffic-Aware Cruise Control to adequately slow down Model Y. Always watch the road in front of you and be prepared to take corrective action at all times. Failure to do so can result in serious injury or death.
- ⚠ **Warning:** Although Traffic-Aware Cruise Control is capable of detecting pedestrians and cyclists, never depend on Traffic-Aware Cruise Control to adequately slow Model Y down for them. Always watch the road in front of you and be prepared to take corrective action at all times. Failure to do so can result in serious injury or death.
- ⚠ **Warning:** Do not use Traffic-Aware Cruise Control on city streets or on roads where traffic conditions are constantly changing.
- ⚠ **Warning:** Do not use Traffic-Aware Cruise Control on winding roads with sharp curves, on icy or slippery road surfaces, or when weather conditions (such as heavy rain, snow, fog, etc.) make it inappropriate to drive at a consistent speed. Traffic-

Aware Cruise Control does not adapt driving speed based on road and driving conditions.

## To Use Traffic-Aware Cruise Control

To use Traffic-Aware Cruise Control, you must be driving at least 18 mph (30 km/h), unless a vehicle is detected ahead of you. If a vehicle is detected ahead of you, you can use Traffic-Aware Cruise Control at any speed, even when stationary, provided Model Y is at least 5 feet (150 cm) behind the detected vehicle.



When Traffic-Aware Cruise Control is available but is not actively cruising at a specified set speed, the touchscreen displays a gray speedometer icon below your current driving speed. The number shown in gray is your current driving speed, or the speed limit that is being determined by Speed Assist (see [Controlling Speed Assist](#) on page 116), whichever is greater. If you engage Traffic-Aware Cruise Control, this is the cruising speed that will be set.

**Note:** On roads where the map data determines that a conditional speed limit exists (for example, a speed limit based on time of day or weather conditions), a second speed limit displays below the first speed limit. It is the driver's responsibility to determine whether the conditional speed limit is currently in effect and adjust the driving speed accordingly.

## Set the Cruising Speed

To set the cruising speed, move the cruise control lever fully down once then release. This sets the cruising speed to the detected speed limit (plus any offset you've specified using Speed Assist as described in [Controlling Speed Assist](#) on page 116) or your current driving speed, whichever is greater.



Release the accelerator pedal to allow Traffic-Aware Cruise Control to maintain your cruising speed.



When the cruising speed is set, the speedometer icon on the touchscreen turns blue and displays the set cruising speed.

**Note:** Moving the gear level fully down twice in quick succession engages Autosteer (assuming it has been enabled as described in [Autosteer](#) on page 91) and the set speed changes to either your current driving speed, or the current set speed (displayed in the icon), whichever is greater.

**Note:** The minimum speed you can set is 18 mph (30 km/h) and the maximum is 90 mph (150 km/h). It is the driver's responsibility to cruise at a safe speed based on road conditions and speed limits.

- Warning:** When cruising at the speed limit, the cruising speed does not change when the speed limit changes. If your driving speed is at or below the new speed limit, move the lever up to cancel Traffic-Aware Cruise Control, then move it back down again to re-initiate and cruise at the new speed limit. You can also manually adjust your cruising speed (see [Changing the Set Speed](#) on page 87).
- Warning:** Do not rely on Traffic-Aware Cruise Control or Speed Assist to determine an accurate or appropriate cruising speed. Always cruise at a safe speed based on road conditions and applicable speed limits.

## Cruising at the Set Speed

Traffic-Aware Cruise Control maintains your set cruising speed whenever a vehicle is not detected in front of Model Y. When cruising behind a detected vehicle, Traffic-Aware Cruise Control accelerates and decelerates Model Y as needed to maintain a chosen following distance (see [Adjust the Following Distance](#) on page 88), up to the set speed.

Traffic-Aware Cruise Control also adjusts the cruising speed when entering and exiting curves.

You can manually accelerate at any time when cruising at a set speed, but when you release the accelerator, Traffic-Aware Cruise Control resumes cruising at the set speed.

**Note:** When Traffic-Aware Cruise Control is actively slowing down Model Y to maintain the selected distance from the vehicle ahead, brake lights turn on to alert other road users that you are slowing down. You may notice slight movement of the brake pedal. However, when Traffic-Aware Cruise Control is accelerating Model Y, the accelerator pedal does not move.

- Warning:** Traffic-Aware Cruise Control may occasionally cause Model Y to brake when not required or when you are not expecting it. This can be caused by closely following a vehicle ahead, detecting vehicles or objects in adjacent lanes (especially on curves), etc.
- Warning:** Due to limitations inherent in the onboard GPS (Global Positioning System), you may experience situations in which Traffic-Aware Cruise Control slows down the vehicle, especially near highway exits where a curve is detected and/or you are actively navigating to a destination and not following the route.
- Warning:** Traffic-Aware Cruise Control cannot detect all objects and, especially in situations when you are driving over 50 mph (80 km/h), may not brake/ decelerate when a vehicle or object is only partially in the driving lane or when a vehicle you are following moves out of your driving path and a stationary or slow-moving vehicle or object is in front of you. Always pay attention to the road ahead and stay prepared to take immediate corrective action. Depending on Traffic-Aware Cruise Control to avoid a collision can result in serious injury or death. In addition, Traffic-Aware Cruise Control may react to vehicles or objects



that either do not exist or are not in the lane of travel, causing Model Y to slow down unnecessarily or inappropriately.

- Warning:** Traffic-Aware Cruise Control may be unable to provide adequate speed control because of limited braking capability and hills. It can also misjudge the distance from a vehicle ahead. Driving downhill can increase driving speed, causing Model Y to exceed your set speed (and potentially the road's speed limit). Never depend on Traffic-Aware Cruise Control to slow down the vehicle enough to prevent a collision. Always keep your eyes on the road when driving and be prepared to take corrective action as needed. Depending on Traffic-Aware Cruise Control to slow the vehicle down enough to prevent a collision can result in serious injury or death.

## Changing the Set Speed

To change the set speed while using Traffic-Aware Cruise Control, roll the right scroll wheel up (to increase) or down (to decrease) the set speed until your desired set speed is displayed. Slowly rolling the scroll wheel changes the set speed in 1 mph (1 km/h) increments and quickly rolling the scroll wheel changes the set speed to the closest 5 mph (5 km/h) increment.



You can also use the touchscreen to change the set speed by touching the plus (+) or minus (-) next to the displayed set speed. A quick tap changes the set speed by 1 mph (1 km/h) and a press and hold changes the set speed to the closest 5 mph (5 km/h) increment. To increase/decrease to the next increment, you must release the plus (+) or minus (-) then press it again.



**Note:** It may take a few seconds for Model Y to reach the new cruising speed, assuming Model Y does not detect a vehicle ahead driving slower than your set speed.

If the touchscreen is displaying a speed limit sign, you can touch this sign to set the cruising speed to the current speed limit (plus any offset you've specified using Speed Assist).

## HOLD State

When following a vehicle, Traffic-Aware Cruise Control remains active at low speeds, even when Model Y comes to a full stop. When the vehicle is moving again, Traffic-Aware Cruise Control resumes operating at the set speed. However, under the following circumstances, Traffic-Aware Cruise Control goes into a **HOLD** state, in which case, you need to briefly press the accelerator pedal to resume cruising. When the **HOLD** status is active, the touchscreen displays the **HOLD** icon and a message that indicates that you need to resume cruise control. The following circumstances can cause Traffic-Aware Cruise Control to go into the **HOLD** state:

- Model Y has been at a standstill for 5 minutes.
- Model Y detects a pedestrian (the **HOLD** state may clear when the pedestrian is no longer detected).
- Model Y suddenly loses visibility of the vehicle in front of you.
- The ultrasonic sensors detect an obstacle in front of Model Y.





## Cruising Near or On Freeway Exits

When cruising near an exit on a controlled access road (such as a highway or freeway) and engaging the turn signal toward the exit, Traffic-Aware Cruise Control assumes you are exiting and begins to slow down the vehicle. If you do not drive onto the exit, Traffic-Aware Cruise Control resumes cruising at the set speed. In a region with right hand traffic, this occurs only when you engage the right turn signal when driving in the right-most lane within 164 feet (50 meters) of an exit. Likewise in regions with left hand traffic; when engaging the left turn signal when driving in the left-most lane within 164 feet (50 meters) of an exit.

**Note:** The onboard Global Positioning System (GPS) determines if you are driving in a region with right or left hand traffic. In situations where GPS data is unavailable (for example, if there is inadequate signal), engaging the turn signal near an exit does not cause Traffic-Aware Cruise Control to slow down Model Y.

When enabled while on a highway interchange or off-ramp, Traffic-Aware Cruise Control may reduce your set speed in 5 mph (5 km/h) increments – to as slow as 25 mph (40 km/h) – to better match the reported speeds of other Tesla vehicles that have driven at that specific location. To override this and continue cruising at your set speed, tap the accelerator pedal or touch the plus (+) or minus (-) button on the touchscreen. The new set speed is maintained for the duration of the interchange or off-ramp (unless you override it or cancel Traffic-Aware Cruise Control). After the interchange or off-ramp, the set speed may revert or change as necessary based on the new location. For example, if you merged onto a different highway, the set speed reverts back to the set speed that was in use before driving on the interchange.

**Warning:** In some cases (such as having insufficient data), Traffic-Aware Cruise Control may not automatically reduce the set speed on the highway interchange or off-ramp. Do not rely on Traffic-Aware Cruise Control to determine an appropriate driving speed. Tesla recommends driving at a speed that is safe for road conditions and within posted speed limits.

## Adjust the Following Distance

To adjust the following distance you want to maintain between Model Y and a vehicle traveling ahead of you, press the steering wheel's right scroll button to the left or right to choose a setting from 1 (the closest following distance) to 7 (the longest following distance). Each setting corresponds to a time-based distance that represents how long it takes for Model Y, from its current location, to reach the location of the rear bumper of the vehicle ahead of you.



You can also display and adjust the setting for the following distance on the touchscreen at any time, even when Traffic-Aware Cruise Control is not active. Touch **Controls** > **Autopilot** > **Cruise Follow Distance**, then adjust the following distance by touching plus (+) or minus (-).



As you adjust the following distance, the touchscreen displays the current setting.



**Note:** Your setting is retained until you manually change it.

**Warning:** It is the driver's responsibility to determine and maintain a safe following distance at all times. Do not rely on Traffic-Aware Cruise Control to maintain an accurate or appropriate following distance.



- Warning:** Never depend on Traffic-Aware Cruise Control to adequately slow down Model Y to avoid a collision. Always watch the road in front of you and stay prepared to take immediate corrective action.

## Overtake Acceleration

When following a vehicle with Traffic-Aware Cruise Control active, briefly engaging the turn signal (to indicate a move into the passing lane) accelerates Model Y towards the vehicle ahead. By momentarily holding the turn signal lever up or down, you can quickly accelerate up to your set speed without having to press the accelerator pedal. The turn signal causes acceleration only when all of the following conditions are met:

- Traffic-Aware Cruise Control is operating and detects a vehicle in front of you.
- No obstacles or vehicles are detected in the target lane.
- Model Y is traveling below the set speed, but over 45 mph (72 km/h).

Overtake Acceleration is intended as an aid when passing a vehicle ahead of you. When the turn signal is engaged, Traffic-Aware Cruise Control continues to maintain distance from the vehicle ahead, but allows you to drive slightly closer than your selected distance.

Acceleration cancels when one of the conditions happen:

- You reach your set cruising speed.
- Changing lanes takes too long.
- Model Y gets too close to the vehicle ahead.

OR

- You disengage the turn signal.

**Note:** Overtake Acceleration occurs when you hold the turn signal in the momentary position (partially engaged). When you release the turn signal, Model Y stops accelerating (in the same way as when you release the accelerator pedal) and resumes the set speed.

- Warning:** Overtake Acceleration can cancel for many unforeseen reasons in addition to those listed above (for example, lack of GPS data). Stay alert and never depend on Overtake Acceleration to increase your driving speed.

- Warning:** Overtake Acceleration increases your driving speed whenever the appropriate turn signal is engaged, and accelerates Model Y closer to the vehicle

ahead. Although Traffic-Aware Cruise Control continues to maintain distance from the vehicle ahead, it is important to be aware that your selected following distance is reduced when Overtake Acceleration is active, particularly in cases where it may not be your intention to overtake the vehicle you are following.

## Canceling and Resuming

To manually cancel Traffic-Aware Cruise Control, move the gear lever up and release or press the brake pedal. The speedometer icon on the touchscreen turns gray to indicate that Traffic-Aware Cruise Control is no longer active.

- Warning:** Do not hold the gear lever up for more than one second. Doing so cancels Traffic-Aware Cruise Control and shifts Model Y into Neutral.



To re-enable cruising at the current driving speed, move the gear lever fully down once then release.



**Note:** When Traffic-Aware Cruise Control cancels, Model Y does not coast. Instead, regenerative braking slows down Model Y in the same way as when you move your foot off the accelerator when driving without Traffic-



Aware Cruise Control (see [Regenerative Braking](#) on page 69).

**Warning:** Traffic-Aware Cruise Control cancels, or may not be available, in the following situations:

- You press the brake pedal.
- Your driving speed exceeds the maximum cruising speed of 90 mph (150 km/h).
- You shift Model Y into a different gear.
- A door is opened.
- The view from the radar sensor or camera(s) is obstructed. This could be caused by dirt, mud, ice, snow, fog, etc.
- The traction control setting is manually disabled or is repeatedly engaging to prevent wheels from slipping.
- The wheels are spinning while at a standstill.
- The Traffic-Aware Cruise Control system is failing or requires service.

When Traffic-Aware Cruise Control is unavailable or cancels, Model Y no longer drives consistently at a set speed and no longer maintains a specified distance from the vehicle ahead.

**Warning:** Traffic-Aware Cruise Control can cancel unexpectedly at any time for unforeseen reasons. Always watch the road in front of you and stay prepared to take appropriate action. It is the driver's responsibility to be in control of Model Y at all times.

## Summary of Cruise Indicators

50

Traffic-Aware Cruise Control is available but is not actively controlling your speed until you activate it. The number shown in gray is determined by Speed Assist (see [Controlling Speed Assist](#) on page 116).

61  
MAX

Traffic-Aware Cruise Control is operating and is either maintaining the set speed (no vehicle in front) or is maintaining a chosen following distance from a vehicle ahead (up to the set speed).

0  
HOLD

Model Y has fully stopped but is in a **HOLD** state. If safe, press the accelerator pedal to resume cruising at the set speed.

## Limitations

Traffic-Aware Cruise Control is particularly unlikely to operate as intended in the following types of situations:

- The road has sharp curves.
- Visibility is poor (due to heavy rain, snow, fog, etc.).
- Bright light (such as from oncoming headlights or direct sunlight) is interfering with the view of the camera(s).
- The radar sensor is obstructed (dirty, covered, etc.).
- The windshield is obstructing the view of the camera(s) (fogged over, dirty, covered by a sticker, etc.).

**Warning:** The list above does not represent an exhaustive list of situations that may interfere with proper operation of Traffic-Aware Cruise Control.



**Note:** Autosteer is a BETA feature.

Autosteer builds upon Traffic-Aware Cruise Control (see [Traffic-Aware Cruise Control](#) on page 85), intelligently keeping Model Y in its driving lane when cruising at a set speed. Autosteer also allows you to use the turn signals to move Model Y into an adjacent lane (see [Auto Lane Change](#) on page 93). Using the vehicle's camera(s), the radar sensor, and the ultrasonic sensors, Autosteer detects lane markings and the presence of vehicles and objects to steer Model Y.

**Note:** Touch **Controls** > **Autopilot** > **Full Self-Driving Visualization Preview** to display more details about the roadway and its surroundings, such as road markings, stop signs, stop lights, objects (such as trash cans and poles), etc.

- ⚠ **Caution:** Ensure all cameras and sensors are clean. Unclean cameras and sensors, as well as environmental conditions such as rain and faded lane markings, can affect Autopilot performance.
- ⚠ **Warning:** Autosteer is a hands-on feature. You must keep your hands on the steering wheel at all times.
- ⚠ **Warning:** Autosteer is intended for use only on highways and limited-access roads with a fully attentive driver. When using Autosteer, hold the steering wheel and be mindful of road conditions and surrounding traffic. Do not use Autosteer on city streets, in construction zones, or in areas where bicyclists or pedestrians may be present. Never depend on Autosteer to determine an appropriate driving path. Always be prepared to take immediate action. Failure to follow these instructions could cause damage, serious injury or death.

## Operating Autosteer

Before you can operate Autosteer, you must enable it by touching **Controls** > **Autopilot** > **Autosteer (Beta)**.



To indicate that Autosteer is available (but not actively steering Model Y), the touchscreen displays a gray Autosteer icon.

To initiate Autosteer, move the gear lever fully down twice in quick succession.



Autosteer briefly displays a message on the touchscreen reminding you to pay attention to the road and be ready to take over at any time. To indicate that Autosteer is now actively steering Model Y, the touchscreen displays the Autosteer icon in blue. When Autosteer is able to detect lane markings, it also displays the driving lane in blue.

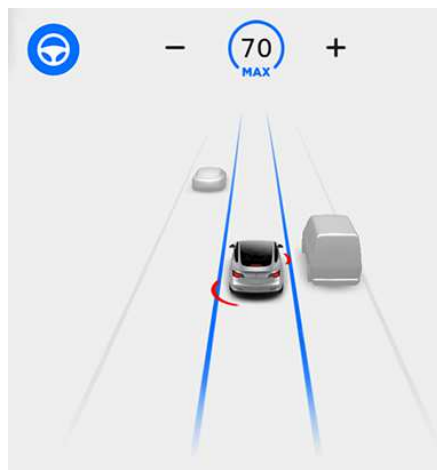

**Note:** To initiate Autosteer when there is no vehicle in front of you, you must be driving at least 18 mph (30 km/h) on a roadway with visible lane markings. If a vehicle is detected ahead of you, you can initiate Autosteer at any speed under 90 mph (150 km/h), even when stationary (if you are at least 5 feet (150 cm) away from the vehicle).



The touchscreen displays a message indicating that Autosteer is temporarily unavailable if you attempted to engage Autosteer when driving at a speed that is not within the speed required for Autosteer to operate. Autosteer may also be unavailable if it is not receiving adequate data from the camera(s) or sensors.

If Autosteer is unable to detect lane markings, the driving lane is determined based on the vehicle you are following.

In most cases, Autosteer attempts to center Model Y in the driving lane. However, if the sensors detect the presence of an obstacle (such as a vehicle or guard rail), Autosteer may steer Model Y in a driving path that is offset from the center of the lane.

**Warning:** Autosteer is not designed to, and will not, steer Model Y around objects partially or completely in the driving lane. Always watch the road in front of you and stay prepared to take appropriate action. It is the driver's responsibility to be in control of Model Y at all times.

### Restricted Speed

Autosteer is intended for use only by a fully attentive driver on freeways and highways where access is limited by entry and exit ramps. If you choose to use Autosteer on residential roads, a road without a center divider, or a road where access is not limited, Autosteer may limit the maximum allowed cruising speed and the touchscreen displays a message indicating that speed is restricted. The restricted speed can vary depending on whether or not you've specified a speed limit offset. Although you will be unable to increase the cruising speed, you can select a more restrictive cruising speed by reducing the speed limit offset, if applicable, (see [Controlling Speed Assist](#) on page 116) or by manually reducing the set cruising speed (see [Changing the Set Speed](#) on page 87).

In situations where the speed limit cannot be detected when Autosteer is engaged, Autosteer reduces your driving speed and limits the set speed to 45 mph (70 km/h). Although you can manually accelerate to exceed the limited speed, Model Y may not brake for detected obstacles. Autosteer slows down to the limited speed when you release the accelerator pedal. When you leave the road, or disengage Autosteer by using the steering wheel, you can increase your set speed again, if desired.

### Hold Steering Wheel

Autosteer uses data from the camera(s), sensors, and GPS to determine how best to steer Model Y. When active, Autosteer requires you to hold the steering wheel. If it does not detect your hands on the steering wheel for a period of time, a flashing blue light appears at the top of the car status section of the touchscreen and the following message displays:

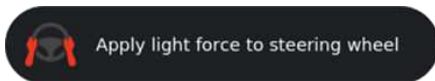

Autosteer detects your hands by recognizing light resistance as the steering wheel turns, or from you manually turning the steering wheel very lightly (without enough force to retake control). Autosteer also qualifies your hands as being detected if you engage a turn signal or use a button or scroll wheel on the steering wheel.

**Note:** When your hands are detected, the message disappears and Autosteer resumes normal operation.

**Note:** Autosteer may also sound a chime at the same time that the message is initially displayed.

Autosteer requires that you pay attention to your surroundings and remain prepared to take control at any time. If Autosteer still does not detect your hands on the steering wheel, the request escalates by sounding chimes that increase in frequency.

If you repeatedly ignore Autosteer's prompts for having your hands on the steering wheel, Autosteer disables for the rest of the drive and displays the following message. If you don't resume manual steering, Autosteer sounds a continuous chime, turns on the warning flashers, and slows the vehicle to a complete stop.

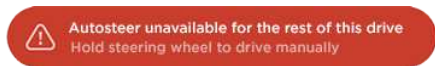

For the rest of the drive, you must steer manually. Autosteer is available again on your next drive (after you stop and shift Model Y into Park).

### Take Over Immediately

In situations where Autosteer is unable to steer Model Y, Autosteer sounds a warning chime and displays the following message on the touchscreen:



## Take over immediately

When you see this message, **TAKE OVER STEERING IMMEDIATELY.**

### Canceling Autosteer

Autosteer cancels when:

- You start steering manually.
- You press the brake pedal.
- The maximum speed that Autosteer supports—90 mph (150 km/h)—is exceeded.
- You move the gear lever upwards.
- A door is opened.
- An Automatic Emergency Braking event occurs (see [Collision Avoidance Assist](#) on page 113).

When Autosteer cancels, it sounds chimes and the Autosteer icon either turns gray to indicate that Autosteer is no longer active, or disappears to indicate that it is not currently available.

**Note:** If Autosteer cancels because you started steering manually, Traffic-Aware Cruise Control remains active. Disengage Traffic-Aware Cruise Control as you normally would, by moving the gear lever upward or pressing the brake pedal.

**Note:** If you move the gear lever upward and hold it up for more than one second, Model Y shifts into Neutral after canceling Autosteer.

To disable Autosteer so it is no longer available, touch **Controls > Autopilot > Autosteer (Beta).**

### Auto Lane Change

When Autosteer is active on a vehicle equipped with Auto Lane Change, you can use the turn signals to move Model Y into an adjacent lane without moving the steering wheel (which would cancel Autosteer).

**Warning:** It is the driver's responsibility to determine whether a lane change is safe and appropriate. Therefore, before initiating a lane change, always check blind spots, lane markings, and the surrounding roadway to confirm it is safe and appropriate to move into the target lane.

**Warning:** Never depend on Auto Lane Change to determine an appropriate driving path. Drive attentively by watching the road and traffic ahead of you, checking the surrounding area, and monitoring the touchscreen for warnings. Always be prepared to take immediate action.

**Warning:** Do not use Auto Lane Change on city streets or on roads where traffic conditions are constantly changing and where bicycles and pedestrians are present.

**Warning:** The performance of Auto Lane Change depends on the ability of the camera(s) to recognize lane markings.

**Warning:** Do not use Auto Lane Change on winding roads with sharp curves, on icy or slippery roads, or when weather conditions (such as heavy rain, snow, fog, etc.) may be obstructing the view from the camera(s) or sensors.

**Warning:** Failure to follow all warnings and instructions can result in property damage, serious injury or death.

### Operating Auto Lane Change

Auto Lane Change is available whenever Autosteer is active. To change lanes using Auto Lane Change:

1. Perform visual checks to make sure it is safe and appropriate to move into the target lane
2. Fully engage the appropriate turn signal.
3. Disengage the turn signal after you are in the target lane.

Auto Lane Change moves Model Y into the adjacent lane in the direction indicated by the turn signal, provided the following conditions are met:

- The turn signal is fully engaged.
- The ultrasonic sensors and Autopilot cameras do not detect a vehicle or obstacle up to the center of the target lane.
- The lane markings indicate that a lane change is permitted.
- The view of the camera(s) is not obstructed.
- Your vehicle does not detect another vehicle in its blind spot.
- Midway through the lane change, Auto Lane Change can detect the outside lane marking of the target lane.



- Driving speed is at least 30 mph (45 km/h).

As the lane change is in progress, Overtake Acceleration is activated, allowing Model Y to accelerate closer to a vehicle in front (see [Overtake Acceleration](#) on page 89). Midway through the lane change, Auto Lane Change must detect the target lane's outside lane marking. If this lane marking cannot be detected, the lane change is aborted and Model Y returns to its original driving lane.

**Note:** Auto Lane Change moves Model Y one lane at a time. Moving into an additional lane requires you to engage the turn signal a second time after the first lane change is complete.

When using Auto Lane Change, it is important to monitor its performance by watching the driving path in front of you and the surrounding area. Stay prepared to take over steering at any time. As you are crossing over into the adjacent lane, the touchscreen displays the lane marking as a dashed blue line. Once in your new lane, lane markings are displayed as solid blue lines again.

In situations where Auto Lane Change is unable to operate at optimal performance, or cannot operate due to inadequate data, the touchscreen displays a series of warnings. Therefore, when using Auto Lane Change, always pay attention to the touchscreen and be prepared to manually steer Model Y.

## Stop Light and Stop Sign Warning (U.S. only)

Depending on market region or vehicle configuration, Stop Light and/or Stop Sign Warning may not be available on your vehicle.

While Autosteer is in use, Model Y displays a warning on the touchscreen and sounds a chime if it detects that you are likely to run through a red stop light or stop sign. If this happens, **TAKE IMMEDIATE CORRECTIVE ACTION!**

The visual and audible warnings cancel after a few seconds, or when you press the brake pedal, whichever comes first.

**Note:** Touch **Controls > Autopilot > Full Self-Driving Visualization Preview** to display more details about the roadway and its surroundings, such as road markings, stop signs, stop lights, objects (such as trash cans and poles), etc.

**⚠ Caution:** Stop Light and Stop Sign Warning require the vehicle's map to know that a particular stop light or stop sign exists in a certain location. It may be unaware of new stop lights or stop signs that are not captured in the map data. Therefore, Stop Light and Stop Sign Warning may not detect all stop lights and stop signs due to potential map inaccuracies.

**⚠ Warning:** Stop Light and Stop Sign Warning do not apply the brakes or decelerate Model Y and may not detect all stop lights and stop signs. Stop Light and Stop Sign Warning are designed for guidance purposes only and are not a substitute for attentive driving and sound judgment. Keep your eyes on the road when driving and never depend on Stop Light and Stop Sign Warning to warn you of a stop light or stop sign.

**⚠ Warning:** Stop Light and Stop Sign Warning are designed to only warn you when approaching a visible red stop sign, solid red or later portion of a yellow traffic light; it may not issue warnings at intersections with flashing lights and does not warn you of yield signs or temporary stop and yield signs (such as in construction areas). Additionally, Stop Light and Stop Sign Warning will not warn you of an approaching stop light or stop sign if you are pressing the accelerator pedal or brake pedal (which disables Autosteer).

## Navigate on Autopilot

**Note:** Navigate on Autopilot is a BETA feature and is not available in all market regions.

When using Autosteer on a controlled-access road (such as a highway or freeway), Navigate on Autopilot automatically exits at off-ramps and interchanges based on your navigation route. Along the highway portion of a navigation route, Navigate on Autopilot also changes lanes to prepare for exits and to minimize the driving time to your destination.

**⚠ Warning:** Navigate on Autopilot does not make driving autonomous. You must pay attention to the road, keep your hands on the steering wheel at all times, and remain aware of your navigation route.

**⚠ Warning:** As is the case with normal driving, be extra careful around blind corners, highway interchanges, and exits



because obstacles can appear quickly and at any time.

- ⚠ **Warning:** Navigate on Autopilot may not recognize or detect oncoming vehicles, stationary objects, and special-use lanes such as those used exclusively for bikes, carpools, emergency vehicles, etc. Remain alert at all times and be prepared to take immediate action. Failure to do so can cause damage, injury or death.

### Enabling and Customizing Navigate on Autopilot

To enable Navigate on Autopilot, touch **Controls > Autopilot > Navigate on Autopilot (Beta)**. Then, to customize how you want Navigate on Autopilot to operate, touch **CUSTOMIZE NAVIGATE ON AUTOPILOT**:

- Enable At Start Of Every Trip:** Choose whether or not you want to automatically enable Navigate on Autopilot for every navigation route. When enabled, the Navigate on Autopilot button on the turn-by-turn direction list is already enabled at the start of every trip.
- Speed Based Lane Changes:** Navigate on Autopilot is designed to perform both route-based and speed-based lane changes. Route-based lane changes are designed to keep you on your navigation route (for example, moving you into an adjacent lane to prepare for an upcoming off-ramp) whereas speed-based lane changes are designed to maintain a driving speed (not to exceed your cruising speed) that allows you to minimize the time it takes to reach your destination (for example, moving into an adjacent lane to pass a vehicle in front of you). Speed-based lanes changes are optional. You can use this setting to disable speed-based lane changes or to specify how aggressively you want Navigate on Autopilot to change lanes to achieve the set cruising speed. The **MILD** setting is more conservative about lane changes and may result in a slightly longer driving time whereas **MAD MAX** is designed to allow you to reach your destination in the shortest driving time possible, but will only change lanes when safe to do so.

- Require Lane Change Confirmation:** By default, Navigate on Autopilot requires your confirmation before proceeding with a lane change (by engaging the appropriate turn signal). However, if you want Navigate on Autopilot to change lanes without requiring this confirmation, turn this setting off. When you turn the setting off, you can specify if or how you want to be notified of lane changes (**Off**, **Chime**, **Vibrate**, or **Both**).

- ⚠ **Warning:** If you turn off **Require Lane Change Confirmation**, Navigate on Autopilot notifies you of upcoming lane changes and off-ramps, but it remains your responsibility to monitor the environment and maintain control of Model Y at all times. Lane changes can occur quickly and suddenly. Always keep your hands on the wheel and your eyes on the driving path in front of you.

**Note:** In addition to route-based and speed-based lane changes, Navigate on Autopilot also requests a lane change to the right as a reminder to stay out of the left-most lane when you are not passing other vehicles.

**Note:** The touchscreen displays route-based lane changes at the top of the map's turn-by-turn direction list to notify you that an upcoming lane change is needed to stay on the navigation route.

### Operating Navigate on Autopilot

Once enabled, the Navigate on Autopilot button appears on the map's turn-by-turn direction list whenever a navigation route is active and the route includes at least one controlled-access road. Touch this button to allow Navigate on Autopilot to assist you on your journey. When enabled, the Navigate on Autopilot button is blue and the turn-by-turn direction displays the Autosteer icon next to maneuvers (such as freeway exits) that Navigate on Autopilot will handle.

Navigate on Autopilot activates and deactivates as appropriate, based on the type of road you are driving on. For example, if Autosteer is active and the Navigate on Autopilot setting is turned on, Navigate on Autopilot automatically becomes active when you reach a supported controlled-access portion of your navigation route.

Whenever Navigate on Autopilot is active, the touchscreen displays the driving lane as a single blue line in front of Model Y:





When Navigate on Autopilot is active and you approach an off-ramp or freeway interchange along your navigation route, the appropriate turn signal engages and Autosteer maneuvers Model Y onto the off-ramp or interchange.

**Warning:** Never depend on Navigate on Autopilot to determine an appropriate lane at an off-ramp. Stay alert and perform visual checks to ensure that the driving lane is safe and appropriate.

When you leave a controlled-access road (for example, you exit a freeway or you enter a section of the navigation route that is no longer supported), Navigate on Autopilot reverts back to Autosteer— a unique triple-tone chime sounds and the touchscreen displays the driving lane lines in blue (instead of the single blue in front of Model Y). When you exit onto an off-ramp, the touchscreen briefly displays a countdown message warning you of the distance remaining before Navigate on Autopilot reverts back to Autosteer.

**Note:** The way Navigate on Autopilot determines navigation routes and maneuvers at freeway interchanges can be impacted by whether or not the navigation system is set up to use High Occupancy Vehicle (HOV) lanes. Therefore, ensure the **Use HOV Lanes** setting is appropriate for your circumstances (see [Maps and Navigation](#) on page 132). If the setting is off, Navigate on Autopilot never uses an HOV lane, regardless of time of day. If the setting is on, Navigate on Autopilot will always include the use of the HOV lane, whenever it exists.

**Warning:** Even when Navigate on Autopilot deactivates at off-ramps, Autosteer remains active. Always be prepared to take appropriate actions such

as stopping at red lights and stop signs, and yielding to other road users.

**Warning:** Navigate on Autopilot may not always attempt to exit at an off-ramp, even when the exit is determined by the navigation route. Always remain alert and be prepared to manually steer onto the off-ramp, or make a required lane change.

You can cancel Navigate on Autopilot at any time by touching the **Navigate on Autopilot** button on the map's turn-by-turn direction list (your vehicle reverts back to Autosteer), or by canceling Autosteer entirely (see [Canceling Autosteer](#) on page 93).

## Lane Changes

Navigate on Autopilot changes lanes to either prepare Model Y for an upcoming off-ramp, to increase your driving speed (not to exceed your set cruising speed), or to move Model Y out of a left-most lane when you are not passing other vehicles. A message displays at the top of the map's turn-by-turn direction list to notify you when an upcoming lane change is required to stay on your navigation route. The line on the touchscreen shows the upcoming driving path:



When the touchscreen displays a message asking you to confirm the lane change, engage the appropriate turn signal. If you do not confirm the lane change within three seconds, a chime sounds to remind you that Navigate on Autopilot requires your confirmation to change lanes.

If **Require Lane Change Confirmation** is turned off, Navigate on Autopilot engages the appropriate turn signal, checks for vehicles and objects, and when appropriate, maneuvers Model Y into the adjacent lane.



If **Require Lane Change Confirmation** is turned on, you must engage the appropriate turn signal to confirm that you want Navigate on Autopilot to make the lane change. If you do not confirm the lane change within three seconds, a chime sounds to remind you that Navigate on Autopilot requires your confirmation to change lanes.

**Note:** If you ignore a route-based lane change suggestion (for example, you are driving in the left lane while approaching an off-ramp on the right side of the highway), Navigate on Autopilot will be unable to maneuver onto the off-ramp and as a result, the navigation system will re-route you to your destination.

**Warning:** Navigate on Autopilot may not always attempt to exit at an off-ramp or change lanes, even when an exit or lane change is determined by the navigation route. Always remain alert and be prepared to manually steer onto an off-ramp, or make a lane change to prepare for, or to exit at, an off-ramp or interchange.

### Be Ready to Assist

When attempting to change lanes or maneuver Model Y, or when approaching construction zones, Navigate on Autopilot may be unable to determine the appropriate driving lane (for example, complex clover leafs and multi-lane off-ramps) and the touchscreen displays an alert indicating that Navigate on Autopilot is trying to maneuver and may require assistance. When you see the message, be prepared to take immediate action to ensure that it is safe and appropriate to complete the lane change or maneuver.

### Limitations

Autosteer and its associated functions are particularly unlikely to operate as intended when:

**Note:** Navigate on Autopilot is a BETA feature and is not available in all market regions.

When using Autosteer on a controlled-access road (such as a highway or freeway), Navigate on Autopilot automatically exits at off-ramps and interchanges based on your navigation route. Along the highway portion of a navigation route, Navigate on Autopilot also changes lanes to prepare for exits and to minimize the driving time to your destination.

- Autosteer is unable to accurately determine lane markings. For example, lane markings are excessively worn, have visible previous markings, have been adjusted due to road construction, are changing quickly (lanes branching off, crossing over, or merging), objects or landscape features are casting strong shadows on the lane markings, or the road surface contains pavement seams or other high-contrast lines.
  - Visibility is poor (heavy rain, snow, fog, etc.) or weather conditions are interfering with sensor operation.
  - A camera(s) or sensor(s) is obstructed, covered, or damaged.
  - Driving on hills.
  - Approaching a toll booth.
  - Driving on a road that has sharp curves or is excessively rough.
  - Bright light (such as direct sunlight) is interfering with the view of the camera(s).
  - The sensors are affected by other electrical equipment or devices that generate ultrasonic waves.
  - A vehicle is detected in your blind spot when you engage the turn signal.
  - Model Y is being driven very close to a vehicle in front of it, which is blocking the view of the camera(s).
- Warning:** Many unforeseen circumstances can impair the operation of Autosteer. Always keep this in mind and remember that as a result, Autosteer may not steer Model Y appropriately. Always drive attentively and be prepared to take immediate action.
- Warning:** Navigate on Autopilot does not make driving autonomous. You must pay attention to the road, keep your hands on the steering wheel at all times, and remain aware of your navigation route.
- Warning:** As is the case with normal driving, be extra careful around blind corners, highway interchanges, and exits because obstacles can appear quickly and at any time.
- Warning:** Navigate on Autopilot may not recognize or detect oncoming vehicles, stationary objects, and special-use lanes such as those used exclusively for bikes, carpools, emergency vehicles, etc. Remain alert at all times and be prepared



to take immediate action. Failure to do so can cause damage, injury or death.

## Enabling and Customizing Navigate on Autopilot

To enable Navigate on Autopilot, touch **Controls > Autopilot > Navigate on Autopilot (Beta)**. Then, to customize how you want Navigate on Autopilot to operate, touch **CUSTOMIZE NAVIGATE ON AUTOPILOT**:

- **Enable At Start Of Every Trip:** Choose whether or not you want to automatically enable Navigate on Autopilot for every navigation route. When enabled, the Navigate on Autopilot button on the turn-by-turn direction list is already enabled at the start of every trip.
- **Speed Based Lane Changes:** Navigate on Autopilot is designed to perform both route-based and speed-based lane changes. Route-based lane changes are designed to keep you on your navigation route (for example, moving you into an adjacent lane to prepare for an upcoming off-ramp) whereas speed-based lane changes are designed to maintain a driving speed (not to exceed your cruising speed) that allows you to minimize the time it takes to reach your destination (for example, moving into an adjacent lane to pass a vehicle in front of you). Speed-based lane changes are optional. You can use this setting to disable speed-based lane changes or to specify how aggressively you want Navigate on Autopilot to change lanes to achieve the set cruising speed. The **MILD** setting is more conservative about lane changes and may result in a slightly longer driving time whereas **MAD MAX** is designed to allow you to reach your destination in the shortest driving time possible, but will only change lanes when safe to do so.

- **Require Lane Change Confirmation:** By default, Navigate on Autopilot requires your confirmation before proceeding with a lane change (by engaging the appropriate turn signal). However, if you want Navigate on Autopilot to change lanes without requiring this confirmation, turn this setting off. When you turn the setting off, you can specify if or how you want to be notified of lane changes (**Off**, **Chime**, **Vibrate**, or **Both**).

**⚠ Warning:** If you turn off **Require Lane Change Confirmation**, Navigate on Autopilot notifies you of upcoming lane changes and off-ramps, but it remains your responsibility to monitor the environment and maintain control of Model Y at all times. Lane changes can occur quickly and suddenly. Always keep your hands on the wheel and your eyes on the driving path in front of you.

**Note:** In addition to route-based and speed-based lane changes, Navigate on Autopilot also requests a lane change to the right as a reminder to stay out of the left-most lane when you are not passing other vehicles.

**Note:** The touchscreen displays route-based lane changes at the top of the map's turn-by-turn direction list to notify you that an upcoming lane change is needed to stay on the navigation route.

## Operating Navigate on Autopilot

Once enabled, the Navigate on Autopilot button appears on the map's turn-by-turn direction list whenever a navigation route is active and the route includes at least one controlled-access road. Touch this button to allow Navigate on Autopilot to assist you on your journey. When enabled, the Navigate on Autopilot button is blue and the turn-by-turn direction displays the Autosteer icon next to maneuvers (such as freeway exits) that Navigate on Autopilot will handle.

Navigate on Autopilot activates and deactivates as appropriate, based on the type of road you are driving on. For example, if Autosteer is active and the Navigate on Autopilot setting is turned on, Navigate on Autopilot automatically becomes active when you reach a supported controlled-access portion of your navigation route.

Whenever Navigate on Autopilot is active, the touchscreen displays the driving lane as a single blue line in front of Model Y:



When Navigate on Autopilot is active and you approach an off-ramp or freeway interchange along your navigation route, the appropriate turn signal engages and Autosteer maneuvers Model Y onto the off-ramp or interchange.

**Warning:** Never depend on Navigate on Autopilot to determine an appropriate lane at an off-ramp. Stay alert and perform visual checks to ensure that the driving lane is safe and appropriate.

When you leave a controlled-access road (for example, you exit a freeway or you enter a section of the navigation route that is no longer supported), Navigate on Autopilot reverts back to Autosteer— a unique triple-tone chime sounds and the touchscreen displays the driving lane lines in blue (instead of the single blue in front of Model Y). When you exit onto an off-ramp, the touchscreen briefly displays a countdown message warning you of the distance remaining before Navigate on Autopilot reverts back to Autosteer.

**Note:** The way Navigate on Autopilot determines navigation routes and maneuvers at freeway interchanges can be impacted by whether or not the navigation system is set up to use High Occupancy Vehicle (HOV) lanes. Therefore, ensure the **Use HOV Lanes** setting is appropriate for your circumstances (see [Maps and Navigation](#) on page 132). If the setting is off, Navigate on Autopilot never uses an HOV lane, regardless of time of day. If the setting is on, Navigate on Autopilot will always include the use of the HOV lane, whenever it exists.

**Warning:** Even when Navigate on Autopilot deactivates at off-ramps, Autosteer remains active. Always be prepared to take appropriate actions such

as stopping at red lights and stop signs, and yielding to other road users.

**Warning:** Navigate on Autopilot may not always attempt to exit at an off-ramp, even when the exit is determined by the navigation route. Always remain alert and be prepared to manually steer onto the off-ramp, or make a required lane change.

You can cancel Navigate on Autopilot at any time by touching the **Navigate on Autopilot** button on the map's turn-by-turn direction list (your vehicle reverts back to Autosteer), or by canceling Autosteer entirely (see [Canceling Autosteer](#) on page 93).

## Lane Changes

Navigate on Autopilot changes lanes to either prepare Model Y for an upcoming off-ramp, to increase your driving speed (not to exceed your set cruising speed), or to move Model Y out of a left-most lane when you are not passing other vehicles. A message displays at the top of the map's turn-by-turn direction list to notify you when an upcoming lane change is required to stay on your navigation route. The line on the touchscreen shows the upcoming driving path:



If **Require Lane Change Confirmation** is turned off, Navigate on Autopilot engages the appropriate turn signal, checks for vehicles and objects, and when appropriate, maneuvers Model Y into the adjacent lane.

If **Require Lane Change Confirmation** is turned on, you must engage the appropriate turn signal to confirm that you want Navigate on Autopilot to make the lane change. If you do not confirm the lane change within three seconds, a chime sounds to remind you that Navigate on Autopilot requires your confirmation to change lanes.

**Note:** If you ignore a route-based lane change suggestion (for example, you are driving in the



left lane while approaching an off-ramp on the right side of the highway), Navigate on Autopilot will be unable to maneuver onto the off-ramp and as a result, the navigation system will re-route you to your destination.

**⚠ Warning:** Navigate on Autopilot may not always attempt to exit at an off-ramp or change lanes, even when an exit or lane change is determined by the navigation route. Always remain alert and be prepared to manually steer onto an off-ramp, or make a lane change to prepare for, or to exit at, an off-ramp or interchange.

### **Be Ready to Assist**

When attempting to change lanes or maneuver Model Y, or when approaching construction zones, Navigate on Autopilot may be unable to determine the appropriate driving lane (for example, complex clover leafs and multi-lane off-ramps) and the touchscreen displays an alert indicating that Navigate on Autopilot is trying to maneuver and may require assistance. When you see the message, be prepared to take immediate action to ensure that it is safe and appropriate to complete the lane change or maneuver.



Autopark (if equipped) uses data from the ultrasonic sensors and GPS to simplify parking on public roads by maneuvering Model Y into parallel and perpendicular parking spaces. See [To Use Autopark](#) on page 101.

**⚠ Caution:** Ensure all cameras and sensors are clean. Unclean cameras and sensors, as well as environmental conditions such as rain and faded lane markings, can affect Autopilot performance.

**⚠ Warning:** Autopark's performance depends on the ability of the ultrasonic sensors to determine the vehicle's proximity to curbs, objects, and other vehicles.

## To Use Autopark

When driving, follow these steps to allow Autopark to maneuver Model Y into a parking space:

1. When driving slowly on a public road, monitor the touchscreen to determine when Autopark has detected a parking space. When Autopark detects a potential parking space, the touchscreen displays a parking icon. Autopark detects parallel parking locations when driving below 15 mph (24 km/h) and perpendicular parking locations when driving below 10 mph (16 km/h).

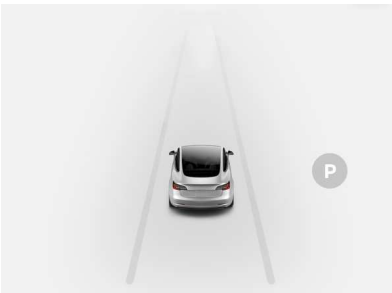

**Note:** The parking icon appears only if the vehicle's position and/or the circumstances of the surrounding area are such that Autopark can determine an appropriate driving path. If Autopark cannot determine an appropriate path (for example, when driving on a narrow street where moving into the parking space causes the front of the vehicle to extend into the adjacent lane), you can either reposition the vehicle, find a different parking space, or park manually.

2. Check to determine if the detected parking space is appropriate and safe. If so, pull forward and stop approximately a car length ahead of the parking space (as you normally would when parallel parking or when backing into a perpendicular parking space).
3. Release the steering wheel, shift Model Y into Reverse, then touch **Start Autopark** on the touchscreen.
4. When parking is complete, Autopark displays the "Complete" message.

In situations where Autopark cannot operate due to inadequate sensor data, the touchscreen displays a message indicating that you must manually park Model Y.

**Note:** If you press the brake when Autopark is actively parking Model Y, the parking process pauses until you touch **Resume** on the touchscreen.

**Note:** Autopark detects potential perpendicular parking spaces that are at least 9.5 feet (2.9 meters) wide with a vehicle parked on each side. Autopark detects parallel parking spaces that are at least 20 feet (6 meters), but less than 30 feet (9 meters) long. Autopark does not operate on angled parking spaces.

**⚠ Warning:** Never depend on Autopark to find a parking space that is legal, suitable, and safe. Autopark may not always detect objects in the parking space. Always perform visual checks to confirm that a parking space is appropriate and safe.

**⚠ Warning:** When Autopark is actively steering Model Y, the steering wheel moves in accordance with Autopark's adjustments. Do not interfere with the movement of the steering wheel. Doing so cancels Autopark.

**⚠ Warning:** During the parking sequence, continually check your surroundings. Be prepared to apply the brakes to avoid vehicles, pedestrians, or objects.

**⚠ Warning:** When Autopark is active, monitor the touchscreen to ensure that you are aware of the instructions that Autopark is providing.

## To Pause Parking

To pause Autopark, press the brake pedal once. Model Y stops and remains stopped until you touch **Resume** on the touchscreen.



## To Cancel Parking

Autopark cancels the parking sequence when you manually move the steering wheel, change gears, or touch **Cancel** on the touchscreen. Autopark also cancels parking when:

- The parking sequence exceeds seven moves.
- Model Y detects that the driver is exiting the vehicle.
- A door is opened.
- You press the accelerator pedal.
- You press the brake pedal while Autopark is paused.
- An Automatic Emergency Braking event occurs (see [Collision Avoidance Assist](#) on page 113).

## Limitations

Autopark is particularly unlikely to operate as intended in these situations:

- The road is sloped. Autopark is designed to operate on flat roads only.
- Visibility is poor (due to heavy rain, snow, fog, etc.).
- The curb is constructed of material other than stone, or the curb cannot be detected.
- The target parking space is directly adjacent to a wall or pillar (for example, the last parking space of a row in an underground parking structure).
- One or more of the ultrasonic sensors is damaged, dirty, or obstructed (such as by mud, ice, or snow).
- Weather conditions (heavy rain, snow, fog, or extremely hot or cold temperatures) are interfering with sensor operation.
- The sensors are affected by other electrical equipment or devices that generate ultrasonic waves.

**⚠ Warning:** Many unforeseen circumstances can impair Autopark's ability to park Model Y. Keep this in mind and remember that as a result, Autopark may not steer Model Y appropriately. Pay attention when parking Model Y and stay prepared to immediately take control.



Summon (if equipped) allows you to automatically park and retrieve Model Y while you are standing outside the vehicle. Summon uses data from the ultrasonic sensors to move Model Y forward and reverse up to 39 feet (12 meters) in, or out of, a parking space.

To move Model Y a longer distance while steering around objects, you can use Smart Summon (if equipped) and your mobile phone. Smart Summon allows your vehicle to find you (or you can send your vehicle to a chosen location). See [Smart Summon](#) on page 106.

- ⚠ **Caution:** Ensure all cameras and sensors are clean. Unclean cameras and sensors, as well as environmental conditions such as rain and faded lane markings, can affect Autopilot performance.
- ⚠ **Warning:** Summon is designed and intended for use only on parking lots and driveways on private property where the surrounding area is familiar and predictable.
- ⚠ **Warning:** Summon is a BETA feature. You must continually monitor the vehicle and its surroundings and stay prepared to take immediate action at any time. It is the driver's responsibility to use Summon safely, responsibly, and as intended.
- ⚠ **Warning:** Summon's performance depends on the ability of the ultrasonic sensors to determine the vehicle's proximity to objects, people, animals, and other vehicles.

## Before Using Summon

Before operating Summon, use the touchscreen to enable it and customize how you want it to work. Touch **Controls** > **Autopilot** > **Summon**, then touch **Customize** and adjust the following settings to suit your preferences:

- **Bumper Clearance:** Set the distance that you want Summon to stop from a detected object (for example, you may want Summon to stop within just a few inches of a garage wall). Note that this distance applies only to objects that Summon detects directly in front of Model Y when moving forward, or directly behind Model Y when reversing.
- **Summon Distance:** Set a maximum distance that Model Y can travel when entering or exiting a parking space.
- **Side Clearance:** Choose an option to specify how much side clearance you want to allow. **Tight** allows Model Y to enter and exit very narrow parking spaces.
  - ⚠ **Warning:** Parking in a narrow space limits the ability of the sensors to accurately detect the location of obstacles, increasing the risk of damage to Model Y and/or surrounding objects.
- **Require Continuous Press:** By default, Summon requires that you press and hold a button on the mobile app or the key fob accessory to move Model Y during the parking process. When **Require Continuous Press** is set to **NO**, you can press and release the button—you don't need to hold it down to keep the vehicle moving. Also, **Require Continuous Press** must be set to **NO** if you want to operate Summon using the key fob accessory instead of the mobile app (see [Operating Summon with the Key](#) on page 104), or if you want to start a parking sequence from inside the vehicle (see [Starting Summon Before Exiting the Vehicle](#) on page 105).
- **Use Auto HomeLink** (if equipped): Set to **ON** if you want to activate HomeLink to open/close a programmed HomeLink device (such as a gate or a garage door) during the parking process when using Summon. If enabled, the device automatically opens and closes when Model Y enters or exits during a Summon session. In a Smart Summon session (if equipped), the device automatically opens when, at the beginning of a session, Smart Summon detects that Model Y is parked in a garage.
  - ⚠ **Warning:** Always ensure that Model Y is fully in or out of a garage before HomeLink lowers the garage door. Summon and Smart Summon (if equipped) cannot detect where an overhead door will lower.

**Note:** When enabled, the HomeLink device automatically opens and closes when using Summon, and automatically opens as needed when using Smart Summon (if equipped). To automate HomeLink in other situations (such as normal driving), you must adjust the HomeLink device's main settings by touching the HomeLink icon at the top of the touchscreen (see [HomeLink Universal Transceiver](#) on page 149).





**Note:** The above settings, with the exception of HomeLink, apply only to Summon—not Smart Summon, if equipped (see [Before Using Smart Summon](#) on page 107). You cannot customize Smart Summon's bumper clearance, distance, and side clearance. And when using Smart Summon, you must always hold down the button on the mobile app to keep Model Y moving. Also, Smart Summon operates with the mobile app only—not the key fob accessory.

**Note:** All settings are retained until you manually change them.

## Using Summon to Park and Retrieve your Vehicle

Follow these steps to use Summon to park your Model Y:

- Align Model Y within 39 feet (12 meters) of the parking space so Model Y can follow a straight path into or out of the space in either Drive or Reverse.
- From outside the vehicle, initiate the parking maneuver by touching **Summon** on the mobile app, then holding down the **FORWARD** or **REVERSE** button.

**Note:** If the **Require Continuous Press** setting is **NO**, you do not need to hold down the button, just press and release.

**Note:** You can also initiate the parking maneuver from inside the vehicle (see [Starting Summon Before Exiting the Vehicle](#) on page 105).

Summon shifts Model Y into Drive or Reverse (based on the direction you specified) and drives into or out of the parking space. When parking is complete, or if an obstacle is detected, Summon shifts Model Y into Park. Summon shifts Model Y into Park when:

- Model Y detects an obstacle in its driving path (within the **Bumper Clearance** setting that you specified).
- Summon has moved Model Y the maximum distance of 39 feet (12 meters).
- You release the **FORWARD** or **REVERSE** button (when Require Continuous Press is turned on).
- You press any button to manually stop Summon.

If you used Summon to park Model Y, you can then use Summon to return Model Y back to its original position (provided the vehicle has remained in Park), or to the maximum **Summon Distance** that you have specified (whichever comes first). Simply specify the opposite direction on the mobile app and Summon moves the vehicle along the original path, provided no obstructions have been introduced. If the ultrasonic sensors detect an obstacle, Summon attempts to avoid the obstacle while staying very close to its original path (Summon does not steer around obstacles).

**Note:** To move Summon multiple times in the same direction (not to exceed the maximum of 39 feet (12 meters), cancel Summon and then restart the parking process using the same direction.

**Note:** Although Summon can move Model Y a short distance laterally to avoid an obstacle, it does not attempt to steer around an obstacle to return the vehicle to its original driving path. Only Smart Summon (if equipped) can steer the vehicle around objects.

**Note:** If you release the direction button on the mobile app, Summon stops moving Model Y.

**Note:** Summon requires that Model Y can detect a valid key nearby.

**Note:** Summon requires that Model Y can detect an authenticated phone nearby (Canada only).

**Warning:** Model Y cannot detect obstacles that are located lower than the bumper, are very narrow, or are hanging from a ceiling (for example, bicycles). In addition, many unforeseen circumstances can impair Summon's ability to move in or out of a parking space and, as a result, Summon may not move Model Y appropriately. Therefore, you must continually monitor the vehicle's movement and its surroundings and remain prepared to stop Model Y at any time.

### Operating Summon with the Key

**Note:** Using the key to operate Summon is available only in the United States.

**Note:** Summon may not operate if the key fob accessory's battery is low.

Follow these steps to park Model Y from outside the vehicle using the key fob accessory:



1. On the touchscreen, ensure that **Require Continuous Press** is disabled (touch **Controls > Autopilot > Summon > Require Continuous Press > NO**).
2. With Model Y in Park, stand within 10 feet (3 meters) and press and hold the top center button on the key fob accessory (Lock/Unlock All button) until the hazard lights blink continuously.  
**Note:** The hazard lights flash once as Model Y locks, then within five seconds, Model Y powers on and the hazard lights flash continuously. Do not proceed to the next step until the hazard lights are flashing. If, after five seconds, the hazard lights are not flashing, release the button on the key fob accessory, move closer to Model Y, and try again. If Summon receives no further input within ten seconds, Summon cancels.
3. Press the Front Trunk button on the key fob accessory to move Model Y forward into the parking space, or press the Rear Trunk button to reverse Model Y into the parking space.

**Starting Summon Before Exiting the Vehicle**

To start a Summon parking sequence before exiting Model Y:

1. On the touchscreen, ensure that **Require Continuous Press** is disabled (touch **Controls > Autopilot > Summon > Require Continuous Press > NO**).
2. Close all doors and trunks.
3. With Model Y powered on and the Park gear engaged, double press the Park button on the gear stalk. The touchscreen displays a popup window.
4. On the touchscreen, choose the direction of travel.
5. Exit Model Y and close the driver’s door.

Summon now moves Model Y according to the direction you specified on the touchscreen.

**Note:** To cancel the parking maneuver before exiting, touch **Cancel** on the popup window.

**Note:** If you do not choose a direction of travel on the touchscreen, Summon does not start a parking maneuver when you exit.

**Stopping or Canceling Summon**

You can stop Model Y at any time while Summon is active by using the mobile app or by pressing any button on the key fob accessory. Summon also cancels when:

- A door handle is engaged or a door is opened.
- You interact with the steering wheel, brake pedal, accelerator pedal, or gear stalk.
- Model Y detects an obstacle.
- Summon has moved Model Y the maximum distance of approximately 39 feet (12 meters).
- Your phone enters sleep mode or loses connectivity to Model Y.

**Limitations**

Summon is unlikely to operate as intended in the following types of situations:







- The driving path is sloped. Summon is designed to operate on flat roads only (up to 10% grade).
- A raised concrete edge is detected. Summon will not move the vehicle over an edge that is higher than approximately 1 in (2.5 cm).
- One or more of the ultrasonic sensors is damaged, dirty, or obstructed (such as by mud, ice, or snow, or by a vehicle bra, excessive paint, or adhesive products such as wraps, stickers, rubber coating, etc.).
- Weather conditions (heavy rain, snow, fog, or extremely hot or cold temperatures) are interfering with sensor operation.
- The sensors are affected by other electrical equipment or devices that generate ultrasonic waves.

**Note:** Summon is disabled if Model Y is in Valet mode (see [Valet Mode](#) on page 51).

**Warning:** The list above does not represent an exhaustive list of situations that may interfere with proper operation of Summon. It is the driver’s responsibility to remain in control of Model Y at all times. Pay close attention whenever Summon is actively moving Model Y and stay prepared to take immediate action. Failure to do so can result in serious property damage, injury or death.



**Smart Summon** (if equipped) is designed to allow you to move Model Y to your location (using your phone's GPS as a target destination) or to a location of your choice, maneuvering around and stopping for objects as necessary. Smart Summon works with the Tesla mobile app when your phone is located within approximately 213 feet (65 meters) of Model Y. Using ultrasonic sensors, cameras, and GPS data, Smart Summon maneuvers Model Y out of parking spaces and around corners. This is useful for moving Model Y out of a tight parking spot, through puddles, or helping you retrieve your car while carrying packages. You must maintain a clear line of sight between you and Model Y and closely monitor the vehicle and its surroundings at all times.

-  **Caution:** Ensure all cameras and sensors are clean. Unclean cameras and sensors, as well as environmental conditions such as rain and faded lane markings, can affect Autopilot performance.
-  **Warning:** Smart Summon is designed and intended for use only on parking lots and driveways located on private property where the surrounding area is familiar and predictable. Do not use Smart Summon on public roads.
-  **Warning:** Smart Summon must only be used on paved surfaces.
-  **Warning:** Smart Summon is a BETA feature. You must continually monitor the vehicle and its surroundings and stay prepared to take immediate action at any time. It is the driver's responsibility to use Smart Summon safely, responsibly, and as intended.
-  **Warning:** Smart Summon may not stop for all objects (especially very low objects such as some curbs, or very high objects such as a shelf) and may not react to all traffic. Smart Summon does not recognize the direction of traffic, does not navigate around empty parking spaces, and may not anticipate crossing traffic.
-  **Warning:** Smart Summon's performance depends on the ultrasonic sensors, the visibility of the cameras, and the availability of an adequate cellular signal and GPS data.
-  **Warning:** When using Smart Summon, you must maintain a clear line of sight between you and Model Y and stay prepared to stop the vehicle at any time

by releasing the button on the mobile app.



## Before Using Smart Summon

- Download the latest version of the Tesla mobile app to your phone, and ensure your phone has cellular service and GPS enabled.
- Your phone must be connected to Model Y and located within approximately 213 feet (65 meters).
- The vehicle's Autopilot cameras must be fully calibrated (see [Drive to Calibrate Cameras](#) on page 83).
- You must have a clear line of sight to Model Y.
- Model Y must be in Park, not charging, and all doors and trunks must be closed.

## Using Smart Summon

1. Open the Tesla mobile app, and press **SUMMON**.
2. Press the **Smart Summon** icon located in the center of the image of your Model Y. It may take several seconds for Smart Summon to start up.

**Note:** You can use Standby Mode to eliminate the delay that occurs when Smart Summon is starting up (see [Standby Mode](#) on page 108).

The mobile app displays a map with a blue circle, which represents the maximum proximity of 213 feet (65 meters) that you must maintain between your phone and Model Y. The blue dot on the map represents your location, and the red arrow represents the location of Model Y.

3. Position yourself anywhere within the blue circle where you have a clear line of sight to Model Y.
4. You can now operate Smart Summon using either of these modes:
  - **COME TO ME** mode: Press and hold the **COME TO ME** button. Model Y moves to your GPS location. As you move, Model Y follows you. When Model Y reaches you, it stops and shifts into park.

- **GO TO TARGET** mode: Touch the crosshair icon then drag the map to position the pin on a chosen destination. Press and hold the **GO TO TARGET** button. Model Y moves to the destination. When reaching the location, Model Y stops and shifts into Park and the mobile app displays a message indicating that Summon has completed.

**Note:** To subsequently change the location, lift your finger, reposition the map, then press and hold **GO TO TARGET** again.

To stop Model Y at any time, simply release the **COME TO ME** or **GO TO TARGET** button.



The map's crosshair icon toggles between **GO TO TARGET** and **COME TO ME** modes. When **COME TO ME** mode is selected, the icon is blue.

**Note:** The map also has an icon that allows you to display/hide satellite imagery.

Immediately after initiating Smart Summon in either mode, hazard lights briefly flash, mirrors fold, and Model Y shifts into the appropriate driving gear (Drive or Reverse). Model Y then slowly moves to within 3 feet (1 meter) of you (**COME TO ME**) or your chosen destination (**GO TO TARGET**), navigating obstacles as needed. As Model Y moves, the corresponding red arrow on the map also moves to show the vehicle's location. As you move, the corresponding blue dot also moves to show your location.

In either mode, Model Y stops moving and shifts into park when:

- You release the button on the mobile app.
- The maximum proximity of 213 feet (65 meters) between your phone and Model Y is exceeded (if moving Model Y to a destination away from you, you may need to follow the car to maintain this distance).
- The driving path is blocked.



- Model Y has moved the maximum distance of 475 feet (145 meters) since the start of the Smart Summon session, or has moved 492 feet (150 meters) away from the location from which the vehicle was last driven manually.

**Note:** If Smart Summon moves Model Y forward three feet and then backwards two feet, this is considered five feet of travel.

**Note:** There is no need to look at the mobile app—just hold down the button while keeping your eye on Model Y and its driving path at all times, remaining ready to release the button to stop the vehicle if needed.

If equipped and Auto HomeLink is enabled for Summon (touch **Controls** > **Autopilot** > **Summon** > **Use Auto HomeLink**, Smart Summon automatically opens a HomeLink device if you start the Smart Summon maneuver when Model Y is located inside a garage. The mobile app informs you that the door has opened.

**Warning:** When you release the button to stop Model Y, a slight delay occurs before the vehicle stops. Therefore, it is critical that you pay close attention to the vehicle's driving path at all times and proactively anticipate obstacles that the vehicle may be unable to detect.

**Warning:** Use extreme caution when using Smart Summon in environments where movement of obstacles can be unpredictable. For example, where people, children or animals are present.

**Warning:** Smart Summon may not stop for all objects (especially very low objects such as some curbs, or very high objects such as a shelf) and may not react to all oncoming or side traffic. Pay attention and be ready to stop Model Y at all times by releasing the button on the mobile app.

## Standby Mode

To keep Model Y ready to Summon and reduce the time it takes to warm up, turn on Standby Mode. Touch **Controls** > **Autopilot** > **Customize Summon** > **Standby Mode**. When Standby Mode is turned on, you can conserve Battery energy by disabling Standby Mode at these locations:

- **Exclude Home** - Disables Standby Mode at the location you set as Home in your Favorites list.

- **Exclude Work** - Disables Standby Mode at the location you set as Work in your Favorites list.
- **Exclude Favorites** - Disables Standby Mode at any location in your Favorites list.

**Note:** To conserve energy, Smart Summon automatically exits Standby mode from midnight to 6:00 am. During these hours, you will experience a delay as Smart Summon starts up.

**Note:** Additional battery power may be consumed while Standby Mode is active.

**Note:** For details on how to designate a location as Home, Work, or Favorites, see [Recent, Favorite, Home and Work Destinations](#) on page 136).

## Stopping or Canceling Smart Summon

Smart Summon stops Model Y whenever you release the button on the mobile app. To resume the Smart Summon session, simply press the **COME TO ME** or **GO TO TARGET** button again.

**Warning:** Always anticipate when you need to stop Model Y. Depending on the quality of the connectivity between the phone and Model Y, there may be a slight delay between when you release the button and when the car stops.

Smart Summon cancels, and requires you to restart it, when:

- A door handle is engaged or a door is opened.
- You interact with the steering wheel, brake pedal, accelerator pedal, or gear stalk.
- Model Y is blocked by an obstacle.
- Smart Summon has moved Model Y the maximum distance of approximately 475 feet (145 meters) within a 213 foot (65 meter) radius of the phone's location. To move further than this distance, you must shift Model Y into a driving gear (Drive or Reverse) and then re-initiate an Smart Summon session.
- Your phone enters sleep mode or loses connectivity to Model Y.

## Limitations

Smart Summon is unlikely to operate as intended in the following types of situations:



- GPS data is unavailable due to poor cellular coverage.
- The driving path is sloped. Smart Summon is designed to operate on flat roads only (up to 10% grade).
- A raised concrete edge is detected. Depending on the height of the concrete edge, Smart Summon may not move Model Y over it.
- One or more of the ultrasonic sensors or cameras is damaged, dirty, or obstructed (such as by mud, ice, or snow, or by a vehicle bra, excessive paint, or adhesive products such as wraps, stickers, rubber coating, etc.).
- Weather conditions (heavy rain, snow, fog, or extremely hot or cold temperatures) are interfering with sensor or camera operation.
- The sensors are affected by other electrical equipment or devices that generate ultrasonic waves.

**Note:** Smart Summon is disabled if Model Y is in Valet mode (see [Valet Mode](#) on page 51).

**⚠ Warning:** The list above does not represent an exhaustive list of situations that may interfere with proper operation of Smart Summon. It is the driver's responsibility to remain in control of Model Y at all times. Pay close attention whenever Smart Summon is actively moving Model Y and stay prepared to take immediate action. Failure to do so can result in serious property damage, injury or death.



The Autopilot cameras and ultrasonic sensors monitor the markers on the lane you are driving in as well as the areas surrounding Model Y for the presence of vehicles or other objects.

When an object is detected in your blind spot or close to the side of Model Y (such as a vehicle, guard rail, etc.), colored lines radiate from the image of your vehicle on the touchscreen. The location of the lines correspond to the location of the detected object. The color of the lines (white, yellow, orange, or red) represent the object's proximity to your vehicle, with white being the farthest and red being very close, requiring your immediate attention. These colored lines only display when driving between approximately 7 and 85 mph (12 and 140 km/h). When Autosteer is active, these colored lines also display if driving slower than 7 mph (12 km/h). However, the colored lines do not display if Model Y is at a standstill (for example, in heavy traffic).



Lane Assist also warns you when a desired lane departure is not appropriate. When you engage the turn signal and a vehicle or object is detected in the adjacent lane you are planning to move into, the touchscreen displays a red lane line to indicate that a vehicle or object is detected. When the vehicle or object is no longer detected, the lane line returns to normal.

**⚠️ Caution:** Ensure all cameras and sensors are clean. Unclean cameras and sensors, as well as environmental conditions such as rain and faded lane markings, can affect Autopilot performance.

**⚠️ Warning:** Lane Assist features are for guidance purposes only and are not intended to replace your own direct visual checks. Before changing lanes, always

visually check the lane you are moving into by using side mirrors and performing the appropriate shoulder checks.

**⚠️ Warning:** Never depend on Lane Assist to inform you of unintentionally driving outside of the driving lane, or informing you that a vehicle is in your blind spot or close to the side of your vehicle. Several external factors can reduce the performance of Lane Assist such as a lack of lane markings or curbs. This may result in false, or lack of, warnings (see [Limitations and Inaccuracies](#) on page 111). It is the driver's responsibility to stay alert, pay attention to the driving lane and always be aware of other road users. Failure to do so can result in serious injury or death.

Lane Assist also consists of the following features to assist you in staying safe in the driving lanes:

- Lane Departure Avoidance
- Emergency Lane Departure Avoidance
- Blind Spot Collision Warning Chime

## Lane Departure Avoidance

Depending on your vehicle's configuration, this feature may not be available.

Lane Departure Avoidance provides steering interventions if Model Y drifts into (or close to) an adjacent lane when driving between 40 and 90 mph (64 and 145 km/h) on major roadways with clearly visible lane markings. Touch **Controls** > **Autopilot** > **Lane Departure Avoidance** and choose:

- **OFF:** You are not warned of lane departures or potential collisions with a vehicle in an adjacent lane.
- **WARNING:** The steering wheel vibrates if a front wheel passes over a lane marking while the associated turn signal is off. A visual warning on the touchscreen is also displayed.
- **ASSIST:** In addition to the steering wheel vibration and a visual warning, Model Y attempts to steer to a safer position in its driving lane if the vehicle detects drifting or a potential collision while the associated turn signal is off.

Your setting is retained until you manually change it.



When Lane Departure Avoidance detects drifting and applies a steering intervention, the designated lane line is highlighted in blue on the touchscreen.

**Note:** Lane Departure Avoidance is intended to help keep you safe, but it does not work in every situation and does not replace the need to remain attentive and in control.

**Warning:** Keep your hands on the steering wheel at all times. If the vehicle senses your hands are not on the steering wheel, Model Y sounds a chime and the hazard warning lights flash.

**Warning:** Steering interventions are minimal and are not designed to move Model Y out of its driving lane. Do not rely on steering interventions to avoid side collisions.

## Emergency Lane Departure Avoidance

Depending on your vehicle's configuration, this feature may not be available.

For emergency situations, Emergency Lane Departure Avoidance attempts to prevent a potential collision with a vehicle in an adjacent lane by steering Model Y back into your driving lane when traveling between 40 and 90 mph (64 and 145 km/h). This operates if the cameras can detect the edge of the lane, such as a lane line or curb. When this steering intervention is applied, you will hear a chime and the touchscreen displays a warning while highlighting the lane line red until Model Y returns to the driving lane. To turn on or off, touch **Controls > Autopilot > Emergency Lane Departure Avoidance**.

## Blind Spot Collision Warning Chime

If you want a chime to sound when a vehicle is in your blind spot and possible collision is detected, touch **Controls > Autopilot > Blind Spot Collision Warning Chime**.

**Warning:** Blind Spot Collision Warning Chime cannot detect every collision. It is the driver's responsibility to remain alert and check their blind spots.

## Adjacent Lane Speed

Due to market region and vehicle configuration, this feature may not be available on your vehicle.

When your vehicle is moving at a significantly faster speed than neighboring lanes, Model Y automatically reduces your driving speed. This is especially helpful in heavy traffic situations or when vehicles are constantly merging into different lanes. When Model Y detects that neighboring driving speeds are significantly slower, the neighboring lane is highlighted with arrows and detected vehicles are highlighted gray on the touchscreen, and your vehicle slows down as appropriate. This functionality can be temporarily overridden by pressing the accelerator pedal. Never rely on Autopilot to determine a safe driving speed; you are responsible for the vehicle and obeying traffic laws.

## Limitations and Inaccuracies

Lane Assist cannot always clearly detect lane markings and you may experience unnecessary or invalid warnings in these situations:

- Visibility is poor and lane markings are not clearly visible (due to heavy rain, snow, fog, etc.). The exact detection zone of the ultrasonic sensors varies depending on environmental conditions.
- Bright light (such as from oncoming headlights or direct sunlight) is interfering with the view of the camera(s).
- A vehicle in front of Model Y is blocking the view of the camera(s).
- The windshield is obstructing the view of the camera(s) (fogged over, dirty, covered by a sticker, etc.).
- Lane markings are excessively worn, have visible previous markings, have been adjusted due to road construction, or are changing quickly (for example, lanes branching off, crossing over, or merging).
- The road is narrow or winding.
- Objects or landscape features are casting strong shadows on lane markers.

Lane Assist may not provide warnings, or may apply inappropriate warnings, in these situations:

- One or more of the ultrasonic sensors is damaged, dirty, or obstructed (such as by mud, ice, or snow).
- Weather conditions (heavy rain, snow, fog, or extremely hot or cold temperatures) are interfering with sensor operation.
- The sensors are affected by other electrical equipment or devices that generate ultrasonic waves.





- An object that is mounted to Model Y is interfering with and/or obstructing a sensor (such as a bike rack or a bumper sticker).

In addition, Lane Assist may not steer Model Y away from an adjacent vehicle, or may apply unnecessary or inappropriate steering, in these situations:

- You are driving Model Y on sharp corners or on a curve at a relatively high speed.
- Bright light (such as from oncoming headlights or direct sunlight) is interfering with the view of the camera(s).
- You are drifting into another lane but an object (such as a vehicle) is not present.
- A vehicle in another lane cuts in front of you or drifts into your driving lane.
- Model Y is traveling slower than 30 mph (48 km/h) or faster than 90 mph (145 km/h).
- One or more of the ultrasonic sensors is damaged, dirty, or obstructed (such as by mud, ice, or snow).
- Weather conditions (heavy rain, snow, fog, or extremely hot or cold temperatures) are interfering with sensor operation.
- The sensors are affected by other electrical equipment or devices that generate ultrasonic waves.
- An object mounted to Model Y (such as a bike rack or a bumper sticker) is interfering with or obstructing a sensor.
- Visibility is poor and lane markings are not clearly visible (due to heavy rain, snow, fog, etc.).
- Lane markings are excessively worn, have visible previous markings, have been adjusted due to road construction or are changing quickly (for example, lanes branching off, crossing over, or merging).

 **Warning:** The lists above do not represent every possible situation that may interfere with Lane Assist warnings. Lane Assist may not operate as intended for many other reasons. To avoid a collision, stay alert and always pay attention to the roadway when driving so you can anticipate the need to take corrective action as early as possible.



The following collision avoidance features are designed to increase the safety of you and your passengers:

- **Forward Collision Warning** - provides visual and audible warnings in situations when Model Y detects that there is a high risk of a frontal collision (see [Forward Collision Warning](#) on page 113).
- **Automatic Emergency Braking** - automatically applies braking to reduce the impact of a frontal collision (see [Automatic Emergency Braking](#) on page 114).
- **Obstacle-Aware Acceleration** - reduces acceleration if Model Y detects an object in its immediate driving path (see [Obstacle-Aware Acceleration](#) on page 115).

**⚠ Caution:** Ensure all cameras and sensors are clean. Unclean cameras and sensors, as well as environmental conditions such as rain and faded lane markings, can affect Autopilot performance.

**⚠ Warning:** Forward Collision Warning is for guidance purposes only and is not a substitute for attentive driving and sound judgment. Keep your eyes on the road when driving and never depend on Forward Collision Warning to warn you of a potential collision. Several factors can reduce or impair performance, causing either unnecessary, invalid, inaccurate, or missed warnings. Depending on Forward Collision Warning to warn you of a potential collision can result in serious injury or death.

**⚠ Warning:** Automatic Emergency Braking is not designed to prevent all collisions. In certain situations, it can minimize the impact of a frontal collision by attempting to reduce your driving speed. Depending on Automatic Emergency Braking to avoid a collision can result in serious injury or death.

**⚠ Warning:** Obstacle-Aware Acceleration is not designed to prevent a collision. In certain situations, it can minimize the impact of a collision. Depending on Obstacle-Aware Acceleration to avoid a collision can result in serious injury or death.

## Forward Collision Warning

The forward looking camera(s) and the radar sensor monitor the area in front of Model Y for the presence of an object such as a vehicle, motorcycle, bicycle, or pedestrian. If a collision is considered likely unless you take immediate corrective action, Forward Collision Warning is designed to sound a chime and highlight the vehicle in front of you in red on the touchscreen. If this happens, **TAKE IMMEDIATE CORRECTIVE ACTION!**



Warnings cancel automatically when the risk of a collision has been reduced (for example, you have decelerated or stopped Model Y, or the object in front of your vehicle has moved out of your driving path).

If immediate action is not taken when Model Y issues a Forward Collision Warning, Automatic Emergency Braking (if enabled) may automatically apply the brakes if a collision is considered imminent (see [Automatic Emergency Braking](#) on page 114).

By default, Forward Collision Warning is turned on. To turn it off or adjust its sensitivity, touch **Controls > Autopilot > Forward Collision Warning**. Instead of the default warning level of **Medium**, you can turn the warning **Off**, or you can choose to be warned **Late** or **Early**.

**Note:** Your chosen setting for Forward Collision Warning is retained until you manually change it.

**⚠ Warning:** The camera(s) and sensors associated with Forward Collision Warning are designed to monitor an approximate area of up to 525 feet (160 meters) in your driving path. The



area being monitored by Forward Collision Warning can be adversely affected by road and weather conditions. Use appropriate caution when driving.

**Warning:** Forward Collision Warning is designed only to provide visual and audible alerts. It does not attempt to apply the brakes or decelerate Model Y. When seeing and/or hearing a warning, it is the driver's responsibility to take corrective action immediately.

**Warning:** Forward Collision Warning may provide a warning in situations where the likelihood of collision may not exist. Stay alert and always pay attention to the area in front of Model Y so you can anticipate whether any action is required.

**Warning:** Forward Collision Warning operates only when driving between approximately 7 mph (10 km/h) and 90 mph (150 km/h).

**Warning:** Forward Collision Warning does not provide a warning when the driver is already applying the brake.

## Automatic Emergency Braking

The forward looking camera(s) and the radar sensor are designed to determine the distance from a detected object traveling in front of Model Y. When a frontal collision is considered unavoidable, Automatic Emergency Braking is designed to apply the brakes to reduce the severity of the impact.

When Automatic Emergency Braking applies the brakes, the touchscreen displays a visual warning and sounds a chime. You may also notice abrupt downward movement of the brake pedal. The brake lights turn on to alert other road users that you are slowing down.



Emergency braking in progress

If driving 35 mph (56 km/h) or faster, the brakes are released after Automatic Emergency Braking has reduced your driving speed by 30 mph (50 km/h). For example, if Automatic Emergency Braking applies braking when driving 56 mph (90 km/h), it releases the brakes when your speed has been reduced to 26 mph (40 km/h).

Automatic Emergency Braking operates only when driving between approximately 7 mph (10 km/h) and 90 mph (150 km/h).

Automatic Emergency Braking does not apply the brakes, or stops applying the brakes, when:

- You turn the steering wheel sharply.
- You press and release the brake pedal while Automatic Emergency Braking is applying the brakes.
- You accelerate hard while Automatic Emergency Braking is applying the brakes.
- The vehicle, motorcycle, bicycle, or pedestrian is no longer detected ahead.

Automatic Emergency Braking is always enabled when you start Model Y. To disable it for your current drive, touch **Controls** > **Autopilot** > **Automatic Emergency Braking**.

**Warning:** It is strongly recommended that you do not disable Automatic Emergency Braking. If you disable it, Model Y does not automatically apply the brakes in situations where a collision is considered likely.

**Warning:** Automatic Emergency Braking is designed to reduce the severity of an impact. It is not designed to avoid a collision.

**Warning:** Several factors can affect the performance of Automatic Emergency Braking, causing either no braking or inappropriate or untimely braking, such as when a vehicle is partially in the path of travel or there is road debris. It is the driver's responsibility to drive safely and remain in control of the vehicle at all times. Never depend on Automatic Emergency Braking to avoid or reduce the impact of a collision.

**Warning:** Automatic Emergency Braking is designed to reduce the impact of frontal collisions only and does not function when Model Y is in Reverse.

**Warning:** Automatic Emergency Braking is not a substitute for maintaining a safe traveling distance between you and the vehicle in front of you.

**Warning:** The brake pedal moves downward abruptly during automatic braking events. Always ensure that the brake pedal can move freely. Do not place material under or on top of the Tesla-supplied driver's floor mat (including an additional mat) and always ensure that the driver's floor mat is properly secured. Failure to do so can impede the ability of the brake pedal to move freely.







## Obstacle-Aware Acceleration

Obstacle-Aware Acceleration is designed to reduce the impact of a collision by reducing motor torque if Model Y detects an object in its driving path. For example, Model Y, while parked in front of a closed garage door with the Drive gear engaged, detects that you have pressed hard on the accelerator pedal. Although Model Y still accelerates and hits the garage door, the reduced torque may result in less damage.

Obstacle-Aware Acceleration is designed to operate only when all of these conditions are simultaneously met:

- A driving gear is engaged (Drive or Reverse).
- Model Y is stopped or traveling less than 10 mph (16 km/h).
- Model Y detects an object in its immediate driving path.

To disable Obstacle-Aware Acceleration, touch **Controls > Autopilot > Obstacle-Aware Acceleration**.

-  **Warning:** Obstacle-Aware Acceleration is designed to reduce the severity of an impact. It is not designed to avoid a collision.
-  **Warning:** Obstacle-Aware Acceleration may not limit torque in all situations. Several factors, including environmental conditions, distance from an obstacle, and a driver's actions, can limit, delay, or inhibit Obstacle-Aware Acceleration.
-  **Warning:** Obstacle-Aware Acceleration may not limit torque when performing a sharp turn, such as into a parking space.
-  **Warning:** Do not rely on Obstacle-Aware Acceleration to control acceleration or to avoid, or limit, the severity of a collision, and do not attempt to test Obstacle-Aware Acceleration. Doing so can result in serious property damage, injury, or death.
-  **Warning:** Several factors can affect the performance of Obstacle-Aware Acceleration, causing an inappropriate or untimely reduction in motor torque. It is the driver's responsibility to drive safely and remain in control of Model Y at all times.

## Limitations and Inaccuracies

Collision Avoidance features cannot always detect all objects, vehicles, bikes, or pedestrians, and you may experience unnecessary, inaccurate, invalid, or missed warnings for many reasons, particularly if:

- The road has sharp curves.
- Visibility is poor (due to heavy rain, snow, fog, etc.).
- Bright light (such as from oncoming headlights or direct sunlight) is interfering with the view of the camera(s).
- The radar sensor is obstructed (dirty, covered, etc.).
- The windshield is obstructing the view of the camera(s) (fogged over, dirty, covered by a sticker, etc.).

 **Warning:** The limitations previously described do not represent an exhaustive list of situations that may interfere with proper operation of Collision Avoidance Assist features. These features may fail to provide their intended function for many other reasons. It is the driver's responsibility to avoid collisions by staying alert, paying attention, and taking corrective action as early as possible.

 **Caution:** If a fault occurs with a Collision Avoidance Assist feature, Model Y displays an alert. Contact Tesla Service.



## How Speed Assist Works

Model Y displays a speed limit on the touchscreen and you can choose if and how you are warned when you exceed the speed limit. You can touch this speed limit sign to automatically change the set speed to the detected speed limit (including any offsets that you have set). Also, instead of using the detected speed limit, you can base warnings on an arbitrary speed limit that you enter manually.

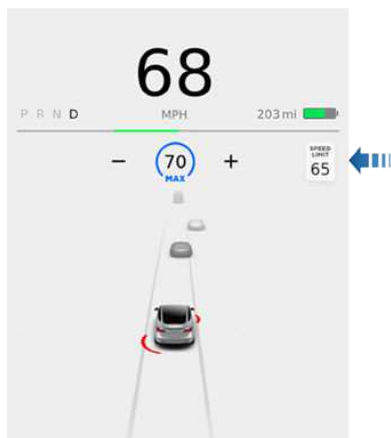

In situations where Model Y is unable to determine a speed limit, or if Speed Assist is uncertain that an acquired speed limit is accurate, the touchscreen may not display a speed limit sign and warnings do not take effect.

If you set the speed limit warning to **Display** (see [Controlling Speed Assist](#) on page 116) and exceed the determined speed limit, the speed limit sign on the touchscreen increases in size.

If you set the speed limit warning to **Chime** (see [Controlling Speed Assist](#) on page 116) and exceed the determined speed limit, the speed limit sign on the touchscreen increases in size and Model Y also sounds a warning chime.

**Note:** Speed limit warnings go away after ten seconds, or when Model Y slows down below the specified limit.

**Warning:** Do not rely on Speed Assist to determine the appropriate speed limit or driving speed. Always drive at a safe speed based on traffic and road conditions.

## Controlling Speed Assist

To adjust the Speed Limit Warning setting, touch **Controls > Autopilot > Speed Limit Warning**, then choose one of these options:

- **Off** - Speed limit warnings do not display and chimes are not sounded.
- **Display** - Speed limit signs display on the touchscreen and the sign increases in size when you exceed the determined limit.
- **Chime** - In addition to the visual display, a chime is sounded whenever you exceed the determined speed limit.

You can also specify how the speed limit is determined:

- **Relative** - You can set a speed limit offset (+ or -) if you want to be alerted only when you exceed the offset speed limit by a specified amount. For example, you can increase the offset to +10 mph (10 km/h) if you only want to be warned when you exceed the speed limit by 10 mph (10 km/h).
- **Absolute** - Manually specify any speed limit between 20 and 140 mph (30 and 240 km/h).

**Note:** Speed Assist is not always accurate. A road's location can be miscalculated and instead Speed Assist can display a speed for a directly adjacent road that may have a different speed limit. For example, Speed Assist can assume Model Y is on a freeway or highway when it is actually on a nearby surface street, and vice versa.

**Note:** Your chosen setting is retained until you manually change it.

## Limitations and Inaccuracies

Speed Assist may not be fully functional or may provide inaccurate information in these situations:

- Visibility is poor and speed limit signs are not clearly visible (due to heavy rain, snow, fog, etc.).
- Bright light (such as from oncoming headlights or direct sunlight) is interfering with the view of the camera(s).
- Model Y is being driven very close to a vehicle in front of it which is blocking the view of the camera(s).
- The windshield is obstructing the view of the camera(s) (fogged over, dirty, covered by a sticker, etc.).



- Speed limit signs are concealed by objects.
- The speed limits stored in the map database are incorrect or outdated.
- Model Y is being driven in an area where GPS or map data is not available.
- Traffic signs do not conform to standard recognizable formats.
- A road or a speed limit has recently changed.

 **Warning:** The list above does not represent an exhaustive list of situations that may interfere with proper operation of Speed Assist. Speed Assist may fail to provide warnings for many other reasons.



## Overview



Touch **Controls** on the bottom corner of the touchscreen to control features and customize Model Y to suit your preferences. The Controls window appears over the map. Touch an option on the left side of the window to display the associated controls and settings. By default, **Quick Controls** displays for quicker access to commonly used settings.



To close the Controls window, touch the **X** in the top left corner, touch **Controls** again, or swipe down on the window.



When an information icon displays beside a specific setting, touch it to display a popup that provides helpful details about the associated setting.

**Note:** The following illustrations are for demonstration purposes only. Depending on vehicle options, software version and market region, the options available may be different.

## Summary of Controls

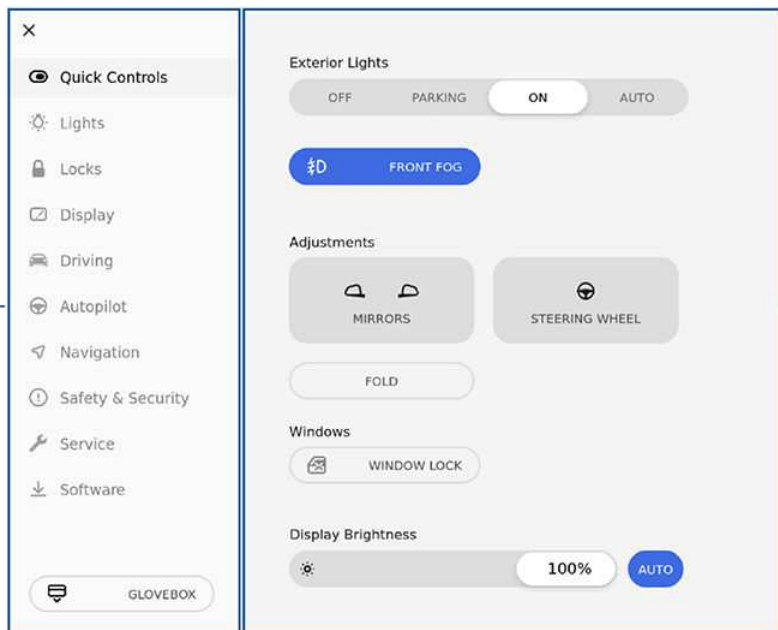

1. Control tabs and open glovebox. When you select an item from the list of tabs, its associated controls and options display in the main viewing area.
2. Main viewing area. The options available for your chosen controls category display here.

**Note:** Depending on vehicle configuration and market region, some settings may not be available for your vehicle.



**Quick Controls** provides easy access to the following commonly-used features:

- **Exterior lights**

<b>OFF</b>	Exterior lights are off until you manually turn them back on. The exterior lights are set to AUTO by default at the start of every drive.
<b>PARKING</b>	The exterior side marker lights, parking lights, tail lights, and license plates lights turn on.
<b>ON</b>	Exterior lights are on.
<b>AUTO</b>	Exterior lights automatically turn on if Model Y detects low lighting conditions.

**Note:** For more information on exterior lights, see [Lights](#) on page 60.

- **Front Fog:** Activates the front fog lights (only available in some regions).
- **Rear Fog:** If equipped (only available in some regions).
- **Adjust the mirrors:** See [Adjusting Exterior Mirrors](#) on page 54.
- **Adjust the steering wheel:** See [Adjusting Steering Wheel Position](#) on page 52.
- **Fold the mirrors:** See [Mirrors](#) on page 54.
- **Window Lock:** Lock the rear window switches (see [Windows](#) on page 17).
- **Display Brightness:** Adjust the brightness of the display.

### Lights

- **Exterior Lights:** Described previously in Quick Controls, or see [Lights](#) on page 60.
- **Front Fog:** (Only available in some regions).
- **Rear Fog:** (Only available in some regions).
- **Interior Lights**

**Dome Lights:** Turn the overhead lights to OFF, ON, or AUTO. When set to AUTO, the dome lights automatically turn on when you unlock the vehicle, open a door upon exiting, or shift into Park.

**Ambient Lights:** If turned on, the interior lights turn on whenever the headlights are on (if equipped).

- **Auto High Beam:** If on, the high beam headlights can automatically switch to low beam when there is light (for example, from an oncoming vehicle) detected in front of Model Y. See [High Beam Headlights](#) on page 61.
- **Headlights after Exit:** If on, the headlights remain on when you stop driving and park Model Y in low lighting conditions. They automatically turn off after one minute or when you lock Model Y.
- **Steering Wheel Lights:** If on, the arrows associated with the scroll buttons on the steering wheel are backlit when the headlights are turned on.





## Locks

- **Keys:** You can see all the keys used for Model Y and their associated driver profiles. You can add, delete, and change the driver profile associated with each key (see [Driver Profiles](#) on page 50).
- **Window Lock:** Lock the rear window switches (see [Windows](#) on page 17).
- **Child-Protection Lock:** If on, safety locks prevent the rear doors from being opened from inside the vehicle (see [Child-Protection Lock](#) on page 16).
- **Unlock on Park:** If on, doors automatically unlock when you engage the Park gear (see [Interior Locking and Unlocking](#) on page 15).
- **Lock Confirmation Sound:** If on, an audible tone sounds when you lock or unlock Model Y.
- **Walk-Away Door Lock:** If on, doors automatically lock when you walk away from the vehicle while carrying your authenticated phone with you (see [Walk-Away Door Lock](#) on page 15).

## Display

- **Display Mode:** Customize the DAY (light background) or NIGHT (dark background) setting of the touchscreen. When set to AUTO, the brightness changes automatically between day and night brightness based on ambient lighting conditions.
- **Brightness:** Drag the slider to manually control the brightness level of the touchscreen. When the AUTO brightness is on, the touchscreen is further adjusted based on both the surroundings and by learning your preferences (for example, it remembers the type of manual adjustments you make).
- **Screen Clean Mode:** When enabled, your touchscreen darkens and is temporarily disabled to facilitate cleaning. Follow the onscreen instructions to exit Screen Clean Mode.

Customize how the units and languages are displayed:

- **Language:** Choose the language that is displayed on the touchscreen.  
**Note:** Model Y must be in Park to change the language. When you change the language, you experience a brief delay as the vehicle shuts down and restarts the touchscreen.
- **Time Format:** Choose if time is displayed in 12 or 24 hour format.
- **Energy Display:** Display remaining energy and charging units as either a percentage of battery energy remaining, or as an estimate of the distance you can drive.
- **Distance:** Choose if miles or kilometers are used when displaying range, speed, energy, trip meters, map searches and navigation routes.
- **Temperature:** Choose if temperature is displayed in °C or °F.
- **Tire Pressure:** Choose if tire pressures are displayed in BAR or PSI.



## Driving

- **Acceleration:** Adjust the amount of acceleration. **Chill** limits acceleration for a slightly smoother and gentler ride, whereas **Standard** or **Sport** (depending on vehicle configuration) provides the normal level of acceleration.  
**Note:** When Chill is selected, **Chill** displays on the touchscreen above the driving speed.
- **Steering Mode:** Adjust the amount of effort required to turn the steering wheel. **Sport** feels more responsive whereas **Comfort** feels easier to drive and park (see [Adjusting Steering Effort](#) on page 52).
- **Regenerative Braking:** When you release the accelerator when driving, regenerative braking slows Model Y and feeds any surplus energy back to the Battery. If set to **LOW**, Model Y does not slow down as quickly, but also feeds less energy back to the Battery (see [Regenerative Braking](#) on page 69).  
**Note:** Regardless of the setting selected, the energy gained by regenerative braking is reduced if the Battery is full, or is extremely cold or hot (in which case, surplus energy is used to heat or cool it).
- **Stopping Mode:** Choose how you want Model Y to behave once regenerative braking has reduced the driving speed to a very low speed, a driving gear is still engaged, and both the accelerator and brake pedals are released. See [Stopping Mode](#) on page 69. You can adjust this setting only when Model Y is in Park.
- **Slip Start:** Turn Slip Start ON to disable traction control and allow wheels to spin to make it easier to dislodge the vehicle when stuck in mud, snow, ice, etc. (see [Traction Control](#) on page 72).
- **Off-Road Assist:** Turn Off-Road Assist ON to disable traction control and allow wheels to spin when driving off-road (see [Traction Control](#) on page 72).



**Autopilot** Control features that provide a safer and more convenient driving experience. Some Autopilot features are not controlled through **Controls**. See [About Autopilot](#) on page 82 for more information.

- **Autosteer (Beta)**: Enable the auto steering feature (available only if your vehicle is equipped with an Autopilot package) (see [Autosteer](#) on page 91).
- **Navigate on Autopilot (Beta)**: Navigate on Autopilot automatically exits at off-ramps and interchanges based on your navigation route and can also make lane changes designed to prepare for exits and minimize the driving time to your destination (available only if your vehicle is equipped with an Autopilot package) (see [Navigate on Autopilot](#) on page 94).

**Customize Navigate on Autopilot**: Specify how Navigate on Autopilot performs lane changes and whether you want it to automatically enable at the start of every trip.

**Note**: Navigate on Autopilot is not available in all market regions.

- **Summon (Beta)**: Automatically park and retrieve Model Y from outside the vehicle (available only if your vehicle is equipped with an Autopilot package) (see [Summon](#) on page 103).
- **Customize Summon**: Determine the bumper clearance, distance, amount of side clearance, and whether Summon requires continuous press when active.
- **Full Self-Driving Visualization Preview**: Display more details about the roadway and its surroundings, such as road markings, stop signs, stop lights, objects (such as trash cans and poles), etc. This may not be available on certain vehicle configurations or in some market regions.
- **Speed Limit Warning**: Select the type of warnings, if any, you receive when you exceed the detected speed limit (see [Speed Assist](#) on page 116).
- **Speed Limit**: Specify if you want Speed Assist to use a relative (with offset) or an absolute speed limit (see [Speed Assist](#) on page 116).
- **Offset**: If relative speed limit is selected, set a speed limit offset if you want to be alerted only when you exceed the offset speed limit by a specified amount.
- **Forward Collision Warning**: Choose if and when you want to receive visual and audible warnings in situations where there is a high risk of a frontal collision (see [Collision Avoidance Assist](#) on page 113).
- **Lane Departure Avoidance**: Specify if you want the steering wheel to vibrate slightly if a front wheel passes over a lane marking and the associated turn signal is off (see [Lane Assist](#) on page 110).
- **Emergency Lane Departure Avoidance**: In emergency situations, Model Y attempts to prevent a potential collision with an object in an adjacent lane by steering the vehicle back into your driving lane (see [Emergency Lane Departure Avoidance](#) on page 111).
- **Blind Spot Collision Warning Chime**: Choose if you want a chime to sound when a vehicle is in your blind spot and a possible collision is detected (see [Blind Spot Collision Warning Chime](#) on page 111).
- **Automatic Emergency Braking**: When toggled on, Model Y automatically applies braking when a frontal collision is imminent (see [Collision Avoidance Assist](#) on page 113).
- **Obstacle-Aware Acceleration**: When toggled on, your vehicle automatically reduces acceleration when an obstacle is detected in front of your vehicle while driving at low speeds (see [Collision Avoidance Assist](#) on page 113).

**Note**: Depending on market regions, options purchased, and software version, your vehicle may not be equipped with all Autopilot features.

## Navigation



Customize how the navigation system works by adjusting these settings:

- **Volume Control:** Increase or decrease the volume of spoken navigation instructions by touching - or +, respectively. Decreasing all the way to the left mutes the instructions. You can also mute navigation instructions when a navigation route is active by touching the volume icon on the turn-by-turn direction list.

**Note:** The volume setting applies only to the navigation system's spoken instructions. Volume for Media Player and Phone remains unchanged.

- **Automatic Navigation:** Provided your phone's calendar is synced to Model Y, you are automatically routed to an event if you get into your vehicle within two hours of an event's start time (if the event on your calendar includes a valid address). Automatically navigate to Home and Work on weekdays (see [Automatic Navigation](#) on page 134).
- **Trip Planner:** (If available in your market region) Use Trip Planner to plan your driving and charging routes (see [Trip Planner](#) on page 136).
- **Online Routing:** When toggled on, you may be automatically rerouted to avoid heavy traffic (see [Online Routing](#) on page 136).
- **Avoid Ferries:** When toggled on, navigation routes avoid the use of ferries.
- **Avoid Tolls:** When toggled on, navigation routes avoid the use of tolls.
- **Use HOV Lanes:** When toggled on, navigation routes include the use of High Occupancy Vehicle (HOV) lanes. This is particularly useful when using Navigate on Autopilot, if equipped (see [Navigate on Autopilot](#) on page 94).

**Note:** You can also display navigation settings by touching the settings icon on the map (see [Maps and Navigation](#) on page 132).



## Safety & Security

- **Parking Brake:** Manually apply and release the parking brake (see [Parking Brake](#) on page 70).
- **Power Off:** You can power off your vehicle.
- **Speed Limit Mode:** Specify if and by how much you want to limit acceleration and max speed (see [Speed Limit Mode](#) on page 126).
- **Sentry Mode:** When on, Sentry Mode uses the vehicle's cameras and sensors to monitor its surroundings while the vehicle is locked and in Park. If a threat is detected, Sentry Mode triggers the Alert or Alarm state, depending on the severity of the threat. You can customize Sentry Mode to automatically enable except in places such as Home, Work, or your Favorites (see [Sentry Mode](#) on page 145).
- **Save Clips on Honk:** When using dashcam, you can determine whether you want to save video recordings to a USB flash drive or other storage device when honking the horn on the steering wheel. You must insert a properly formatted USB flash drive or other storage device in one of your vehicle's front USB ports (see [Dashcam](#) on page 78) and toggle **Save Clips on Honk** ON to enable.
- **Park Assist Chimes:** If on, you an audible beep sounds when approaching an object while parking (see [Park Assist](#) on page 73).
- **Joe Mode:** When enabled, Joe Mode lowers the volume of your vehicle's chimes, except for turn signals.
- **Security Alarm:** Enable the security alarm (see [Security Settings](#) on page 145).
- **Tilt/Intrusion:** (if available) Enable a siren that sounds if Model Y detects motion inside the cabin or if the vehicle is moved or tilted (see [Security Settings](#) on page 145).
- **PIN to Drive:** Increase security by preventing Model Y from being driven until a 4-digit PIN (Personal Identification Number) is entered (see [PIN to Drive](#) on page 145).
- **Cabin Overheat Protection:** Reduce the temperature of the cabin in extremely hot ambient conditions for a period of up to twelve hours after you exit Model Y (see [Cabin Overheat Protection](#) on page 130).
- **Allow Mobile Access:** Allow Tesla's mobile applications to access your Model Y (see [Mobile App](#) on page 155).  
**Note:** To disable Allow Mobile Access, enter your Tesla account credentials on the touchscreen.
- **Data Sharing:** Allow sharing of road measurement data (see [Data Sharing](#) on page 211).

**Note:** Sentry Mode and Cabin Overheat Protection operate only when the energy remaining in the Battery is above 20%.



## Service

- **Wiper Service Mode:** Make wiper blades easy to access (see [Wiper Blades and Washer Jets](#) on page 180).
- **Adjust Headlights:** Make adjustments to the level of the headlights (see [Headlight Adjustments](#) on page 62).
  - ⚠ **Caution:** Headlights should only be adjusted by Tesla Service.
- **Towing:** Prepare Model Y for transporting by keeping it in Neutral (which disengages the parking brake and prevents damage to the rear motor that is caused by wheels turning as Model Y is pulled onto a flatbed truck). See [Instructions for Transporters](#) on page 203.
- **Factory Reset:** Erase all personal data (saved addresses, music favorites, etc.) and restore all customized settings to their factory defaults.
- **Wheel Configuration:** Update your vehicle's wheel configuration if you are installing new wheels or swapping them for different ones. This also changes the wheels of your vehicle's avatar on the touchscreen.
  - Note:** Changing your vehicle's wheel configuration can impact range estimates, tire pressure warning levels, and vehicle visualization. See [Tire Care and Maintenance](#) on page 170 for more information.
  - ⚠ **Warning:** Only use Tesla-approved wheels when installing or swapping wheels. Using non Tesla-approved wheels can cause serious damage. Tesla is not liable for damage caused by using wheels not approved by Tesla.
- **Owner's Manual:** Display this manual. You can also display this manual by touching the Tesla "T" at the top of the touchscreen.

## Software

Learn more about your vehicle and the status of software updates.

- Get more information about your vehicle such as the VIN, vehicle name, and odometer. Touch **Additional vehicle information** to display a list of the various options your vehicle is equipped with.
  - Note:** You can also display some of the vehicle information by touching the Tesla "T" at the top center of your touchscreen.
- View your current software version, map version, and release notes.
- See new updates that are available. Your vehicle must be connected to Wi-Fi to start the update (see [Software Updates](#) on page 153).
- Observe your software's download progress.

The yellow clock icon at the top of the touchscreen is replaced by a green download icon when a software update is available, your vehicle is connected to Wi-Fi, and the update is downloading. A yellow download icon appears when a software update is available, but the vehicle is not connected to Wi-Fi. Ensure your vehicle is connected to Wi-Fi to start the download.

- Customize how often you want to receive software updates by touching **Software Update Preferences**.

**Glovebox** Touch to open the glovebox (see [Glovebox](#) on page 23).

## Naming Your Vehicle

To further personalize Model Y, you can name it. The name of your Model Y appears in the mobile app. To name your vehicle, touch the Tesla "T" at the top center of the touchscreen, then touch **Name Your Vehicle** (or touch the vehicle's existing name). Enter the new name in the popup, then touch **Save**.



## Speed Limit Mode

Speed Limit Mode allows you to limit the acceleration and maximum speed – between 50 and 90 mph (80 and 145 km/h) – of your Model Y. This feature is protected by a 4-digit PIN that you create when enabling it for the first time, and which must be entered whenever you want to disable and enable it.

If your Model Y comes within approximately 3 mph (5 km/h) of the selected maximum speed, a chime sounds and text appears on the touchscreen above the driving speed. Additionally, your mobile app sends you a notification.

To enable Speed Limit Mode:

1. Ensure the vehicle is in Park.
2. Touch **Controls** > **Safety & Security** > **Speed Limit Mode** on the touchscreen or **CONTROLS** in your mobile app.
3. Select the maximum driving speed that you would like to limit the vehicle to.
4. Drag the slider to the **ON** position.
5. Enter the 4-digit PIN that you want to use to disable and enable Speed Limit Mode.

**Note:** If you forget the PIN, you can disable Speed Limit Mode by entering the login credentials for your Tesla Account.

**Note:** When Speed Limit Mode is enabled, the acceleration setting (**Controls** > **Driving** > **Acceleration**) is automatically set to **Chill**.

**Warning:** Driving downhill can increase driving speed, causing the vehicle to exceed your chosen maximum speed.

**Warning:** Speed Limit Mode is not a replacement for good judgment, driver training, and the need to closely monitor roadway speed limits and driving conditions. Accidents can occur at any speed.

## Erasing Personal Data

You can erase all personal data (saved addresses, music favorites, HomeLink programming, etc.) and restore all customized settings to their factory defaults. This is useful when transferring ownership of Model Y. Touch **Controls** > **Service** > **FACTORY RESET**. Before erasing, Model Y verifies your credentials by prompting you to enter the user name and password associated with your Tesla Account.



## Overview of Climate Controls

Climate controls are always available at the bottom of the touchscreen. To turn the climate control system on, touch the fan icon or adjust the cabin temperature. To turn it off, touch the fan icon and then touch the off button near the center of the popup window.

By default, climate control is set to the Auto setting, which maintains optimum comfort in all but the most severe weather conditions. When you adjust the cabin temperature in the Auto setting, the system automatically adjusts the heating, air conditioning, air distribution, and fan speed to maintain the cabin at your selected temperature. To override the Auto setting, touch the fan icon, turn off the Auto setting, then manually adjust your settings (see [Adjusting Climate Control Settings](#) on page 128). If you've manually adjusted individual settings, you can also revert back to Auto at any time by touching **AUTO** on the climate control popup window.

**Note:** The following illustration is provided for demonstration purposes only. Depending on vehicle options, software version, market region, and settings, the information displayed may be slightly different.

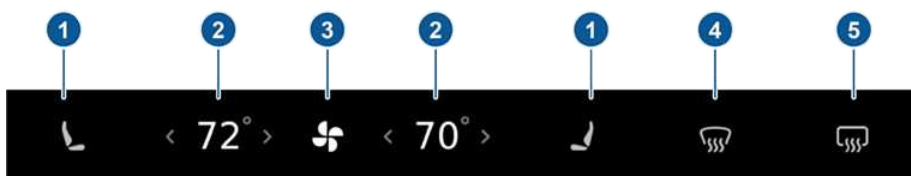

1. Seat heaters operate at three setting levels from 3 (highest) to 1 (lowest). When operating, the associated seat icon displays twisting lines that turn red to indicate the setting level. If equipped with the premium package, rear seats are also equipped with seat heaters (see [Operating Seat Heaters](#) on page 129).
2. Touch an up or down arrow to change the cabin temperature. To apply a temperature setting to both the driver and passenger side, touch **SYNC** on the popup that appears when you touch an arrow. When you apply the same temperature to both sides, only one temperature setting displays. Touch **SYNC** again to display separate temperature settings for the driver and passenger.
3. Touch the fan icon to turn on climate control and to manually customize settings to suit your preferences (see [Adjusting Climate Control Settings](#) on page 128). Touch and hold the fan icon to quickly turn off climate control. If your vehicle is equipped with the premium package, touch this icon to access controls for the rear seat heaters.
4. The windshield defroster distributes air flow to the windshield. Touch once to defog the windshield (the icon turns blue). Touch a second time to defrost the windshield (the icon turns red and the heating and fan operate at maximum levels). Touch a third time to turn off and restore the air distribution, heating, and fan to their previous settings. The exterior side mirrors are also heated whenever the windshield defroster is operating. See [Cold Weather Best Practices](#) on page 80 for more information on preparing for cold weather.
5. Touch to warm up the rear window. When operating, the icon turns red. After 15 minutes, the rear window defroster automatically turns off. The exterior side mirrors are also heated whenever the rear window defroster is operating.

**⚠ Warning:** To avoid burns resulting from prolonged use, individuals who have peripheral neuropathy, or whose capacity to feel pain is limited because of diabetes, age, neurological injury, or some other condition, should exercise caution when using the climate control system and seat heaters.

**Note:** The climate control system is powered by the high voltage battery. Therefore, prolonged use decreases driving range.





## Adjusting Climate Control Settings

To override the Auto setting, touch the fan icon, turn off the Auto setting, then use the buttons that appear to manually adjust settings.



In addition to the settings shown, if Model Y is in Park, the Keep Climate On, Dog Mode, and Camp Mode setting displays when you touch the fan icon when the vehicle is in Park (see [Keep Climate On, Dog Mode, and Camp Mode](#) on page 130).

1. Touch **AUTO** to turn the Auto setting on or off.
2. Touch to turn the climate control system off.
3. The general settings tab displays by default and is represented by the fan icon. Touch the seat heater icon to access controls for the front and rear seat heaters (see [Operating Seat Heaters](#) on page 129).
4. Choose where air flows into the cabin (windshield, face-level, or foot-level vents). You can choose more than one location.

**Note:** When air is directed to the foot-level vents, air continues to flow to the windshield vents to assist in defogging. When air is directed to the face-level vents, air does not flow to the windshield.

5. Touch to turn air flow to the rear cabin area on or off. When on, air flows from the vents located at the back of the center console. See [Adjusting the Rear Vents](#) on page 129.
6. Touch to adjust air flow from the front passenger vent. See [Adjusting the Front Vents](#) on page 129.
7. Touch to choose how air is drawn into Model Y. If on, air inside Model Y is recirculated. If off, outside air is drawn into Model Y.
8. Touch **+** or **-** to increase or decrease the fan speed.

**Note:** Adjusting the fan speed may change the selected setting for how air is drawn into Model Y in order to increase or reduce air flow.

9. Touch to turn the air conditioning system on or off. Turning it off reduces cooling, but saves energy.

**Note:** Because Model Y runs much quieter than a gasoline-powered vehicle, you may notice the sound of the air conditioning compressor as it is operating. To minimize noise, reduce the fan speed.

10. Touch to adjust air flow from the driver's vent. See [Adjusting the Front Vents](#) on page 129.



## Operating Seat Heaters

To control the front seat heaters for the driver and passenger, touch the corresponding control on the main climate control area at the bottom of the touchscreen. To control the rear seat heaters (if equipped) or access duplicate controls for the front seat heaters, touch the fan icon, then touch the seat heater icon followed by the seat for which you want to adjust heating. Seat heaters operate at three setting levels from 3 (highest) to 1 (lowest). When operating, the associated seat icon displays twisting lines that turn red to indicate the setting level. You can touch **All Off** to turn off all seat heaters simultaneously.

## Adjusting the Front Vents

Model Y has a unique horizontal face-level vent that spans the width of the dashboard. Using the touchscreen, you can pinpoint exactly where you want to direct the air flowing from this vent when heating or cooling the front cabin area.

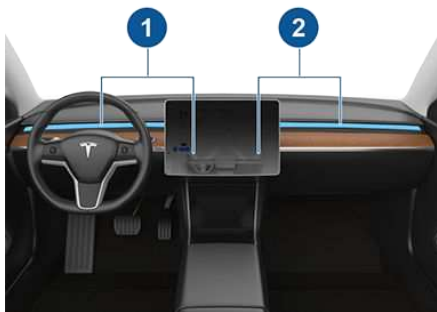

1. Driver vent and controls
2. Passenger vent and controls

When the face-level vent is on you can adjust the direction of the air flow from each vent. To adjust the direction of the air flow, simply touch the radiating air waves from the corresponding vent on the touchscreen. The air flows in a single stream when centered or splits into mirrored air streams when air is directed outward or inward from the center of the vent.

When Model Y detects that there are no passengers sitting in the passenger seat, the passenger vent and controls automatically turn off. Adjust the climate settings to enable passenger air flow.

**Note:** When you split a vent into two separate air flows, the air flow in each direction is not as strong as when all air is flowing in a single direction.

**Note:** Outside air is drawn into Model Y through the grill in front of the windshield. Keep the grill clear of obstructions, such as leaves and snow.

## Adjusting the Rear Vents

Model Y has vents located at the back of the center console where air flows from when the setting is turned on from the touchscreen. To direct the flow of air in the rear cabin area, adjust the vents at the rear of the center console up, down, or from side to side as necessary.

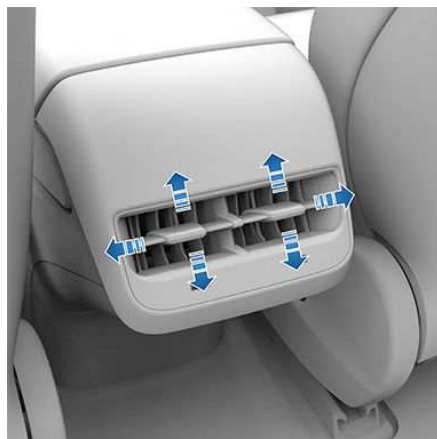



## Keep Climate On, Dog Mode, and Camp Mode

The **Keep Climate On**, **Dog**, and **Camp** settings allow you to keep the climate control system running when in Park, even after you've left Model Y or choose to stay inside the vehicle. These settings are useful when it is important to maintain the cabin temperature in hot or cold weather conditions. For example, when leaving groceries in Model Y on hot days, you may want to use Keep Climate On to prevent spoilage.

Dog mode keeps your pet comfortable while also displaying the current cabin temperature on the touchscreen so people nearby are informed that your pet does not need to be rescued.

Camp Mode allows you to power electronics through the USB ports and 12V outlet in addition to maintaining the cabin temperature. The touchscreen remains on so you can play music, browse the internet, play games in the arcade, or watch shows in Tesla Theater. You can also control media and climate settings from a paired phone. Camp Mode is ideal for remaining inside your vehicle, such as camping or staying with a child.

**Note:** In Camp Mode, Sentry Mode and the vehicle alarm system are disabled.

To operate Keep Climate On, Dog Mode, or Camp Mode:

1. Engage the Park gear. The **Keep Climate On**, **Dog**, and **Camp** settings are available only when Model Y is in Park.
2. If necessary, adjust the climate settings.
3. Touch the fan icon then touch **Keep Climate On**, **Dog**, or **Camp**.

**Note:** To initiate Keep Climate On, Dog Mode, or Camp Mode, the Battery's charge level must be at least 20%.

The climate control system maintains your climate settings until you shift out of Park or manually turn it off. If the Battery's charge level drops below 20%, the Tesla mobile app repeatedly starts sending you notifications reminding you to check on anything that you have left in Model Y.

The next time you drive Model Y, the climate control system continues operating using the previous climate settings from your most recent trip.

**Note:** Software updates cannot be performed when Keep Climate On, Dog Mode, or Camp Mode is active.

**Note:** The intrusion sensor (if equipped) automatically disables when Keep Climate On, Dog Mode, or Camp Mode is active. However, you can override this behavior and keep the intrusion sensor enabled. To do so, touch

**Controls > Safety & Security > Tilt/Intrusion** after enabling Keep Climate On, Dog mode, or Camp mode. However, note that keeping the intrusion sensor enabled while Keep Climate On, Dog Mode, and Camp Mode is active can trigger an alarm event as a result of air movement inside the cabin.

**Warning:** You can adjust the climate control system remotely using the mobile app. However, if you use the mobile app to turn off the climate control system, Keep Climate On, Dog Mode, and Camp Mode stop operating.

**Warning:** Avoid using Keep Climate On, Dog Mode, or Camp Mode when the battery charge is low. When leaving a dog or pet in Model Y, you must ensure that you have your phone with you and that the Tesla mobile app is running. This allows you to proactively monitor the cabin temperature. To ensure the safety and comfort of anyone or anything in your vehicle, always make sure you have adequate cellular coverage to receive notifications and allow enough time to return to Model Y should the climate control system stop operating—on hot days, the cabin temperature can become dangerously high within a few minutes.

**Warning:** Check local laws for any restrictions on leaving pets unattended in your vehicle.

**Warning:** Never leave a child unattended in your vehicle.

## Cabin Air Filter

Model Y has an air filter that prevents pollen, industrial fallout, road dust and other particles from entering through the vents. Tesla recommends replacing the cabin air filter every 2 years.

## Cabin Overheat Protection

The climate control system can reduce the temperature of the cabin in extremely hot ambient conditions for a period of up to twelve hours after you exit Model Y. Touch **Controls > Safety & Security > Cabin Overheat Protection** and choose:

- **OFF:** Disable Cabin Overheat Protection.



- **NO A/C:** Only the fan operates when the cabin temperature exceeds 105° F (40° C). This option consumes less energy but the cabin temperature may exceed 105° F (40° C).
- **ON:** The air conditioning operates when the cabin temperature exceeds 105° F (40° C).

**Note:** Cabin Overheat Protection operates only when the energy remaining in the Battery is above 20%.

**Warning:** Never leave children or pets in the vehicle unattended. Due to automatic shut-off or extreme outside conditions, the inside of the vehicle can become dangerously hot, even when Cabin Overheat Protection is enabled.

## Climate Control Operating Tips

- You can direct the face-level vents toward the windows to help defrost or defog them.
- When you use the mobile app to turn on the climate control system, it automatically turns off after four hours or if the charge level drops to 20%. To cool or heat the cabin for a longer period, you must turn it on again.
- Your charge port latch may freeze in extremely cold weather or icy conditions. In cases where you cannot remove or insert the charge cable, or your vehicle is not Supercharging due to the latch being frozen in place, use your Tesla mobile app to precondition your vehicle on **HI** for approximately 30-45 minutes (you must use your mobile app to precondition the vehicle; setting your climate to **HI** using the touchscreen is not effective). This helps thaw ice on the charge port latch so the charge cable can be removed or inserted. See [Cold Weather Best Practices](#) on page 80 for more information.
- If the climate control system is louder than you prefer, manually reduce the fan speed.
- In addition to cooling the interior, the air conditioning compressor also cools the Battery. Therefore, in hot weather, the air conditioning compressor can turn on even if you turned it off. This is normal because the system's priority is to cool the Battery to ensure it stays within an optimum temperature range to support longevity and optimum performance.
- Even when not in use, you may hear Model Y emit a whining noise or the sound of water circulating. These sounds are normal and occur when the internal cooling systems turn on to support various vehicle functions, such as maintaining the 12V battery and balancing the temperature of the high voltage Battery.
- To ensure the climate control system operates efficiently, close all windows and ensure that the exterior grill in front of the windshield is free of ice, snow, leaves, and other debris.
- In very humid conditions, it is normal for the windshield to fog slightly when you first turn on the air conditioning.
- It is normal for a small pool of water to form under Model Y when parked. Extra water produced by the dehumidifying process is drained underneath.
- Model Y uses a heat pump to maximize efficiency; therefore, your air conditioning compressor and external fan may run and make noise even when the outside temperature is cold and your vehicle is heating or supercharging.
- To reduce the temperature in the cabin in hot weather conditions, the fan may turn on to vent the cabin when the vehicle is parked. This occurs only if the battery's charge level is above 20%.



## Overview

The touchscreen displays a map at all times. To move the map in any direction, hold and drag a finger. To rotate the map in any direction, hold and turn two fingers.

To set the map's orientation, touch the icon in the top right corner of the map:



North Up - North is always at the top of the screen.

Heading Up - The direction you are driving is always at the top of the screen. The map rotates as you change direction. This icon has an integrated compass that indicates the direction you are driving.



**Note:** When navigating, this icon also allows you to view the route overview view and guide you by displaying the current portion of your navigation route (see [Navigating](#) on page 133).

When you rotate or move the map, your current location is no longer tracked. The message "Tracking Disabled" displays briefly next to the map orientation icon and the icon turns gray. To re-enable tracking, touch the map's orientation icon to choose North Up or Heading Up.

Touch the + and - icons to zoom the map in and out on your current or chosen location. When you zoom in or out using these icons, tracking remains enabled.

Touch the following icons to customize what the map displays and to access navigation settings:

**Note:** These icons disappear after a few seconds when not in use. Touch anywhere on the map to re-display them.



Display/hide satellite imagery (if equipped with premium connectivity).



Display/hide traffic conditions (if equipped with premium connectivity). Green lines indicate no traffic; orange lines indicate light traffic; red lines indicate moderate traffic; and pink lines indicate heavy traffic. To ensure traffic is easy to identify along a navigation route, green traffic lines display under the blue route line, whereas orange, red, and pink traffic lines display on top of the blue route line.



Display/hide all charging locations and a popup list that includes the city and proximity of the corresponding stations on the map. Charging locations include Tesla Superchargers, Tesla destination chargers, third party fast chargers (see note below), and public chargers that you have used previously. See [Charging Locations](#) on page 134.

**Note:** In some market regions, third party fast chargers are also included on the map as dark grey pins when you display chargers.

**Note:** The map always displays Superchargers, even when you hide charging locations.



Increase or decrease the volume of spoken navigation instructions by touching **-** or **+**, respectively. Decreasing all the way to the left mutes the instructions. You can also mute navigation instructions when a navigation route is active by touching the volume icon on the turn-by-turn direction list.

Customize how the navigation system works by adjusting these settings (the available settings vary depending on your market region and vehicle configuration):

- Touch **Trip Planner** to minimize the time you spend driving and charging (see [Trip Planner](#) on page 136).
- Touch **Online Routing** to be automatically rerouted to avoid heavy traffic (see [Online Routing](#) on page 136).
- Touch **Avoid Ferries** to be automatically routed to avoid ferries.
- Touch **Avoid Tolls** to be automatically routed to avoid tolls.
- Touch **Use HOV Lanes** to include High Occupancy Vehicle (HOV) lanes on navigation routes. This is particularly useful when using Navigate on Autopilot, if equipped (see [Navigate on Autopilot](#) on page 94).

**Note:** You can also access the above navigation settings by touching **Controls > Navigation**.

**Note:** The volume setting applies only to the navigation system's spoken instructions. Volume for Media Player and Phone remains unchanged.

Drop a pin by pressing and holding your finger anywhere on the map. When you drop a pin, or touch an existing pin, the chosen location is centered on the map, and a popup window provides information about the location. From this popup, you can navigate to the location, call the location (if a phone number is available) and add or remove the location from your list of favorite destinations (see [Recent, Favorite, Home and Work Destinations](#) on page 136).

## Navigating

To navigate to a location, touch **Navigate**, send the destination from your phone, or speak a voice command (see [Using Voice Commands](#) on page 144). You can enter or speak an address, landmark, business, etc. You can also choose a saved **Home** or **Work** location and select from a list of recently used locations (the most recent displays at the top of the list), including charging stations you have visited.

**Note:** To remotely start navigation from your iOS® or Android™ device, use the “share” functionality after giving access to the Tesla mobile app.

When you specify a location, the touchscreen zooms out to provide an overview of the route you need to travel, and, after calculating the route, zooms back in to your starting point and begins to provide instructions. A turn-by-turn direction list displays the first navigation instruction and an estimate of total mileage, driving time, and arrival time. To expand the list to show each turn on your navigation route, touch the instruction. Note the following about the turn-by-turn direction list:

- A battery displays below the destination to provide an estimate of how much battery energy will remain when you reach your destination. Touch to expand battery information to show a round trip estimate back to your starting point. See [Predicting Energy Usage](#) on page 135.
- If charging is needed to reach your destination and Trip Planner is enabled (and available in your market region), the navigation route automatically includes Supercharger stops (see [Trip Planner](#) on page 136) and you may need to touch **BEGIN TRIP** to initiate navigation.
- If you won't have enough energy to reach your destination and there is no Supercharger on the route, an alert tells you that charging is needed to reach your destination.
- Each turn is preceded by the distance to the maneuver.
- To see the bottom of the list, you may need to drag the list upward.
- Touch the top of the list again to minimize it.

While navigating, the map tracks your location and displays the current leg of your trip. You can display the entire route at any time.



If Navigate on Autopilot (if available in your market region) is enabled, you can turn it on for the navigation route by touching **Navigate on Autopilot** in the turn-by-turn direction list. Navigate on Autopilot is an extension of Autosteer that automatically changes lanes and steers Model Y onto the appropriate exit(s) when navigating on controlled access roads (such as freeways). For details, see [Navigate on Autopilot](#) on page 94.



The route overview icon displays when a navigation route is active. Touch this icon at any time to view an overview of your navigation route, or to change the orientation of the map (see [Overview](#) on page 132), which also zooms the map to show the current leg of your trip. The black pin at the end of the route line represents your destination.



Mute/unmute navigation volume.

**Note:** You can also mute the volume of the navigation system by pressing the scroll button on the left side of the steering wheel while navigation instructions are being spoken. A volume control specific to navigation instructions is also available by touching the settings icon on the map (see [Overview](#) on page 132).

To stop navigating, touch **CANCEL**, located below the turn-by-turn direction list.

**Note:** If a data connection is not available, onboard maps allow you to navigate to any location, but you must enter the location's exact and complete address.

## Automatic Navigation

Automatic Navigation can predict a destination when you get in your vehicle. When your phone's calendar is synced to Model Y, and the calendar includes an event that takes place within two hours of when you get in your vehicle to drive, Automatic Navigation suggests the location of the event (assuming a valid address is associated with the event).

In addition, if you are Home and get in your vehicle on weekdays (Monday to Friday) from 5:00 AM to 11:00 AM, Automatic Navigation can automatically route you to your specified Work location (see [Recent, Favorite, Home and Work Destinations](#) on page 136). Likewise, if you are at work on weekdays from 3:00 PM to 11:00 PM, Automatic Navigation can automatically route you to your specified Home location.

To enable Automatic Navigation, touch **Controls > Navigation > Automatic Navigation**. You must have your phone's calendar correctly synced to your vehicle with a uniquely specified and valid address for each event (see [Calendar](#) on page 143). Your Automatic Navigation settings are saved to your Driver Profile (see [Driver Profiles](#) on page 50).

**Note:** Navigation instructions that you enter manually, or send to Model Y, override routes suggested by Automatic Navigation.

**Note:** Availability of this feature depends on market region and vehicle configuration.

## I'm Feeling Lucky, Hungry

In addition to navigating to a destination of your choice, Model Y can also suggest nearby locations based on whether you are feeling **Hungry** or **Lucky**. In the navigation search bar, touch **Hungry** or **Lucky**. **Hungry** suggests popular restaurants, whereas **Lucky** suggests popular destinations (such as museums and amusement parks). For a new suggestion, go back and touch **Hungry** or **Lucky** again for different results. When you discover a destination that interests you, touch **Navigate** to proceed to the destination.

This feature requires the latest version of Navigation maps. To download, connect your vehicle to Wi-Fi and navigate to **Controls > Software** to check if an update is available (see [Map Updates](#) on page 137).

**Note:** Availability of this feature depends on market region and vehicle configuration.

## Charging Locations

The map always displays Supercharger locations, represented by red pins that you can touch to display more information, navigate to it, or mark it as a favorite. The appearance of the pin itself reveals information about the Supercharger location:



The Supercharger location is operational. At locations with multiple Superchargers, a row of bars displays above the icon, with each bar representing a Supercharger. If a Supercharger is in use, the bar is filled in to provide a quick visual that indicates how many Superchargers are currently being used at the location.

**Note:** A Supercharger pin is colored black if located on your current navigation route.



The Supercharger location may be out of operation or is operating at a reduced capacity. Touch the pin to display details.

When you touch the pin for a Supercharger location, a popup displays information, including the total number of Superchargers, the number of Superchargers available, the address of the Supercharger location, and its approximate distance from your current location. The popup also displays amenities that are available at the Supercharger location, including restrooms, restaurants, lodging, shopping, and Wi-Fi.

Touch the map's charging icon to display all nearby charging stations of the map. In addition to the Superchargers, the map displays Tesla's destination chargers, third party fast chargers (see note below), and any public charging stations that you have previously used. Display details about a charging location by touching its pin.

**Note:** In some market regions, third party fast chargers are also included as dark grey pins when you choose to display all charging stations on the map.



The location is equipped with a Tesla Wall Connector. Touch to display more information such as usage restrictions and available charge current. The charging list also displays your proximity to these charging stations.

**Note:** When the map is zoomed out and more than one Tesla Wall Connector is available in an area, the pin is round and displays the number of stations. Touch the pin to zoom in. Then you can touch an individual pins for details about a specific charging location.

**Note:** When navigating to a Supercharger location, Model Y may allocate energy to pre-heat the Battery, ensuring you arrive at the Supercharger with the optimal Battery temperature, reducing the amount of time it takes to charge. In some circumstances (such as cold weather), it is normal for the front motor to make noise as it generates heat to warm the Battery (see [Warming the Battery Before Supercharging](#) on page 81).

## Predicting Energy Usage

When navigating to a destination, Model Y helps you anticipate your charging needs by calculating the amount of energy that remains when you reach your destination. The calculation is an estimate based on driving style (predicted speed, etc.) and environmental factors (elevation changes, temperature, etc.). When navigating, the map displays this calculation at the bottom of the expanded turn-by-turn direction list (see [Navigating](#) on page 133). When the turn-by-turn direction list is compressed, touch the top of the list to expand it.

Throughout your route, Model Y monitors energy usage and updates the calculation. A popup warning displays at the bottom of the turn-by-turn direction list in these situations:

- A yellow warning displays when you have very little energy remaining to reach your destination and should drive slowly to conserve energy. For tips on conserving energy, see [Getting Maximum Range](#) on page 76.
- A red warning displays when you must charge to reach your destination.





If you also want to know if you have enough energy for a round trip, touch the energy calculation to display an estimate of your round trip energy usage.

## Online Routing

Model Y detects real-time traffic conditions and automatically adjusts the estimated driving and arrival times based on traffic. In situations where traffic conditions will delay your estimated time of arrival and an alternate route is available, the navigation system can reroute you to your destination. To turn this feature on or off, touch the map's settings icon (see [Overview](#) on page 132), then touch **Online Routing**. You can also specify the minimum amount of minutes that must be saved before you are rerouted by touching the arrows associated with the **Re-Route if it saves more than** setting.

## Trip Planner

Trip Planner (available in some market regions) helps you take longer road trips with confidence. If reaching your destination requires charging, Trip Planner routes you through the appropriate Supercharger locations. Trip Planner selects a route and provides charging times to minimize the amount of time you spend driving and charging. To enable Trip Planner, touch the map's settings icon (see [Overview](#) on page 132), then touch **Trip Planner**.

When Trip Planner is enabled and charging is required to reach your destination, the turn-by-turn direction list includes Supercharger stops and a recommended charging time at each Supercharger, and an estimate of how much energy will be available when you arrive at the Supercharger.

**Note:** When navigating to a Supercharger using Trip Planner, your vehicle will allocate some energy to pre-heat the Battery. The vehicle arrives at the Supercharger with an optimal Battery temperature, reducing the amount of time it takes to charge (see [Warming the Battery Before Supercharging](#) on page 81).

To remove Supercharger stops and display only directions, touch **Remove charging stops** at the bottom of the list of directions (if you remove charging stops, the turn-by-turn direction list may display an alert indicating that charging is needed to reach your destination). To add Supercharger stops to the directions, touch **Add charging stops**.

While charging at a Supercharger, the charging screen displays the remaining charging time needed to drive to your next Supercharger stop, or destination (if no further charging is needed). If you charge for a shorter or longer length of time, the charging time for subsequent Supercharger stops is adjusted.

**Note:** You can also monitor remaining charging time needed in the Tesla Mobile App.

**Note:** If a Supercharger located on your route experiences an outage, Trip Planner displays a notification and reroutes you to a different Supercharger location.

If Trip Planner estimates that you won't have enough energy for your round trip, and there are no Superchargers available on your route, Trip Planner displays an alert at the top of the turn-by-turn direction list notifying you that charging is needed to reach your destination.

## Recent, Favorite, Home and Work Destinations

When you touch **Navigate** on the map, a list of **Recent** destinations appear and you can easily navigate to any recent destination by selecting it from the list.

If you frequently drive to a destination, you may want to add it as a favorite to avoid having to enter the location's name or address each time. When you add a destination as a Favorite, you can easily navigate to it by touching **Navigate > Favorites** and then selecting it from the list of favorites.



To add a destination to your Favorites list touch its pin on the map, then touch the heart icon on the popup window that appears. You will be prompted to name the Favorite. Enter a name (or leave as-is to accept the default name), then touch **Add to Favorites**. The heart becomes solid gray and the destination is included on the Favorites list.

To delete a Recent or Favorite destination, touch and hold it down briefly, then touch the **X** that appears.



The top of the navigation list also provides shortcuts for **Home** and **Work** locations. Touch to set an address to either of these locations. After entering the address, touch **SAVE AS HOME** or **SAVE AS WORK**. Then simply touch these shortcuts whenever you want to navigate home or to work.

To change the location associated with Home or Work, press and hold the shortcut icon and enter a new address in the popup window. To delete, press and hold the shortcut button, then touch **CLEAR HOME** or **CLEAR WORK**.

**Note:** Based on your usage patterns, you may be prompted to save a location as Home or Work.

**Note:** Once a Home or Work location is saved, Model Y may prompt you to navigate to your Work location in the mornings and to your Home location in the evenings and tell you how long it will take to arrive based on current traffic conditions.

For security reasons, if you sell Model Y, it is recommended that you delete your Home and Work Locations. You can delete these individually or you can perform a factory reset to erase all personal data (see [Erasing Personal Data](#) on page 126).

## Map Updates

As updated maps become available, they are automatically sent to Model Y over Wi-Fi. To ensure you receive them, periodically connect Model Y to a Wi-Fi network (see [Connecting to Wi-Fi](#) on page 152). The touchscreen displays a message informing you when new maps are installed.



## Overview



Touch the Media Player icon at the bottom of the touchscreen to play various types of media through your vehicle's speaker system. The media options available to you depend on market region and options chosen at time of purchase. For example, you can stream internet radio or podcasts (if equipped with premium connectivity), listen to FM radio. You can also play audio files from a Bluetooth or USB-connected device.

Media Player provides three different levels of viewing that you can access by dragging the Media Player window upward or downward. Initially, just the Miniplayer displays. The Miniplayer, which occupies the least amount of space on the touchscreen, displays what's currently playing and provides only the basic functions, mostly associated with what's playing. Drag upward to display Recents and Favorites and access the icons you can use to change your media source (described next). Drag upward again to browse through all available options for the chosen type of source content.

Use the icons across the bottom of Media Player to change your media source (for example, FM, Streaming, or a Bluetooth-connected device). Use the tabs on the left to narrow down the type of content you want to browse through—the associated content displays on the right. For Radio, you can browse through Favorite Stations or you can touch **Direct Tune** to enter the frequency of a specific channel. For Streaming, you can browse through Favorites, Top Stations, DJ Series, and Genres.

## Volume Control

Roll the scroll button on the left side of the steering wheel up or down to increase or decrease volume respectively. The scroll button adjusts the volume for media, navigation instructions, or phone calls, based on what is currently being heard through the speakers. You can also adjust the volume by touching the arrows associated with the speaker icon on the bottom of the touchscreen.

To mute the volume, press the left scroll button. Press again to unmute.

**Note:** Pressing the left scroll button during a phone call mutes both the sound and your microphone.

**Note:** If you're playing media and you receive a phone call, or the navigation system is speaking directions, the volume of what you are listening to is temporarily muted.

## Searching Media Content



Touch Media Player's magnifying glass icon to search for a particular song, album, artist, podcast, or station. Select a filter to narrow the scope of your search, or leave it at its default setting to include top results from all available source content. If available, touch **HD** to play high definition versions of the selected frequency.

**Note:** Use voice commands to search hands-free (see [Using Voice Commands](#) on page 144).

## FM Radio



If available in your market region and location, Media Player provides FM radio stations that you can select from the Radio source. Touch the next or previous arrows to move from one frequency to the next (or previous). Or touch **Direct Tune** to enter a specific frequency. If available, touch **HD** to play high definition versions of the selected frequency.

For easy access to radio stations you listen to frequently, mark it as a favorite so it's readily available in your Favorites list (see [Favorites and Recents](#) on page 139).

## Internet Radio and Music Streaming Services (if equipped)

If equipped with premium connectivity, internet radio and music streaming services are available over a data connection. To listen, touch the Media Player icon and choose the streaming service you want to listen to.



You can use your Tesla account or you can sign in with your own account by scrolling to the bottom of the streaming service window and entering your account credentials.

Browse through the available categories and/or stations, then touch what you want to play. When browsing through a large category such as genres, you may need to drag the window upward to enlarge it and view more available options. When you choose an option that displays multiple results on a new window, touch **BACK** at the top of the window to return to the main browse page.

You can also use voice commands to play a specific song, artist, or album from an Internet radio service (see [Using Voice Commands](#) on page 144).

When listening to internet radio or a music streaming service, the options available on Miniplayer can vary depending on what you are listening to:

- Touch the next (or previous) arrows to play the next (and in some cases previous) available station, episode, or track being provided by the Internet radio service.
- Like or dislike a song or podcast. When you like a song, for example, the radio station plays similar songs. When you dislike a song, the song won't be played again.
- Touch the **DJ** icon (if available) to include commentary for the content you are streaming. DJ commentary includes music history and behind-the-scenes stories.

**Note:** When playing a podcast (if available), you can rewind or fast forward to any location in the show. On the Miniplayer, drag the slider to the desired location or touch the rewind/fast forward icons to move back or forward 15 seconds at a time.

### Caraoke

In addition to various streaming services, your vehicle is equipped with Caraoke. To access Caraoke, touch the Music icon near the bottom of the touchscreen. You can browse through various songs and select the song you want to sing. Touch the microphone icon to enable or disable the song's main vocals. Disabling the microphone leaves only the song's instrumentals and background vocals. Touch the lyrics icon (located next to the microphone icon) to enable or disable the song's lyrics.

**Note:** Depending on vehicle configuration and market region, Caraoke may not be available on your vehicle.

**Warning:** Never read Caraoke lyrics while driving. You must always pay attention to the road and traffic conditions. When driving, the Caraoke lyrics are intended only for use by a passenger.

## Favorites and Recents

For most source content, your favorites display at the top of Media Player's expanded view for easy access.



To add a currently playing station, podcast, or audio file to your Favorites list, touch the **Favorites** icon on Miniplayer.



To remove an item as a favorite, touch the highlighted **Favorites** icon on Miniplayer. You can also remove multiple favorites by expanding Miniplayer one level to show all favorites for the applicable type of source content. Then press and hold any favorite. An **X** appears on all favorites and you can then touch the **X** to remove it from your Favorites list.

To see selections that you have recently played, scroll up one level from Miniplayer and touch **Recent**. Your recently played selections are updated continuously so you don't need to remove them.

**Note:** Selections you play on FM radio are not included in your Recent list.

## Playing Media from Devices



You can play audio files from a Bluetooth-connected device (like a phone) or a USB-connected flash drive. When you connect a Bluetooth-capable device, the name of the device displays when you choose the Phone source. When you connect a USB flash drive, Media Player displays the driver's source content.



To play the next song in a selected playlist or album, touch the previous or next arrows on Miniplayer. You can also shuffle tracks in a playlist or repeat a playlist or track using the shuffle/repeat icons (if available).

## USB Connected Flash Drives

Connect a flash drive to a front USB connection (see [Interior Storage and Electronics](#) on page 23). Touch **Media Player** > **USB**, and then touch the name of the folder that contains the song you want to play. After you display the contents of a folder on the USB connected flash drive, you can touch any song in the list to play it. Or use the previous and next arrows in Miniplayer to scroll through your songs.

**Note:** To play media from a USB connection, Model Y recognizes flash drives only. You can play media from other types of devices (such as an iPod) by connecting the device using Bluetooth.

**Note:** Media Player supports USB flash drives with FAT32 formatting (NTFS and exFAT are not currently supported).

**Note:** Use a USB connection located at the front of the center console. The USB connections at the rear of the console are for charging only.

## Bluetooth<sup>®</sup> Connected Devices

If you have a Bluetooth-capable device such as a phone that is paired and connected to Model Y (see [Pairing a Bluetooth Phone](#) on page 141), you can play audio files stored on it and you can stream music from it. Choose Media Player's **Phone** source, then touch the name of your Bluetooth-connected device, and then touch **CONNECT**.

Your Bluetooth device begins playing the audio file that is currently active on your device, and Media Player displays the Miniplayer view. If no audio file is playing on your device, use your device to choose the audio file you want to listen to. When the chosen file begins to play, you can then use Miniplayer's next and previous icons to play other tracks.

**Note:** To play media from a Bluetooth-connected device, ensure that access to the device's media is turned on (see [Pairing a Bluetooth Phone](#) on page 141).

## Audio Settings



Press the equalizer icon at the bottom corner of Media Player to access audio settings for tone and balance. Other settings may be available based on your vehicle features and market region. For example, you can turn immersive sound on or off, but if equipped with the premium package, you can choose between Standard, High, and Off.

To adjust any of the five frequency bands (Bass, Bass/Mid, Mid, Mid/Treble, and Treble) drag the corresponding slider up or down the decibel (dB) bar.

To adjust balance, touch **Balance** and drag the center circle of the cross bars to the location in Model Y where you want to focus the sound.



## Bluetooth<sup>®</sup> Compatibility

You can use your Bluetooth-capable phone hands-free in Model Y provided your phone is within operating range. Although Bluetooth typically supports wireless communication over distances of up to approximately 30 feet (9 meters), performance can vary based on the phone you are using.

Before using your phone with Model Y, you must pair it. Pairing sets up Model Y to work with your Bluetooth-capable phone (see [Pairing a Bluetooth Phone](#) on page 141).

**Note:** Authenticating your phone to use as a Model Y key (see [Keys](#) on page 9) does not also allow you to use the phone hands-free, play media from it, etc. You must also pair it as described below.

You can pair up to ten Bluetooth phones. Model Y always automatically connects to the last phone that was used (provided it is within range). If you want to connect to a different phone, see [Connecting to a Paired Phone](#) on page 142.

**Note:** On many phones, Bluetooth turns off if the phone's battery is low.

**Note:** In addition to phones, you can also pair Bluetooth-enabled devices with Model Y. For example, you can pair an iPod Touch or an iPad or Android tablet to stream music.

## Pairing a Bluetooth Phone

Pairing allows you to use your Bluetooth-capable phone hands-free to make and receive phone calls, access your contact list, recent calls, etc. It also allows you to play media files from your phone. Once a phone is paired, Model Y can connect to it whenever the phone is within range.

To pair a phone, follow these steps while sitting inside Model Y:

1. Ensure both the touchscreen and the phone are powered on.
2. On your phone, enable Bluetooth and ensure it is discoverable.  
**Note:** On some phones, this may require you to go to Bluetooth Settings for the remainder of the procedure.
3. Touch the Bluetooth icon on the top of the touchscreen.
4. On the touchscreen, touch **Add New Device** > **Start Search**. The touchscreen displays a list of all available Bluetooth devices within operating distance.

5. On the touchscreen, touch the phone with which you want to pair. Within a few seconds, the touchscreen displays a randomly generated number, and your phone should display the same number.
6. Check that the number displayed on your phone matches the number displayed on the touchscreen. Then, on your phone, confirm that you want to pair.
7. If prompted on your phone, specify whether you want to allow Model Y to access your contacts and media files.

When paired, Model Y automatically connects to the phone, and the touchscreen displays the Bluetooth symbol next to the phone's name to indicate that the connection is active.

## Importing Contacts and Recent Calls

Once paired, you can use the Bluetooth settings screen (touch the Bluetooth icon on the touchscreen's top status bar) to specify whether you want to allow access to your phone's contacts and recent calls. If access is turned on, you can use the phone app to display, and make calls to, people in your list of contacts and on your recent calls lists (see [Using the Phone App](#) on page 142).

**Note:** Before contacts can be imported, you may need to either set your phone to allow syncing, or respond to a popup on your phone to confirm that you want to sync contacts. This varies depending on the type of phone you are using. For details, refer to the documentation provided with your phone.

**Note:** You can turn access to your contacts and recent calls on or off at any time by displaying the Bluetooth settings screen, choosing the phone, and then changing the setting associated with contacts and recent calls.

## Unpairing a Bluetooth Phone

If you want to disconnect your phone and use it again later, simply touch **Disconnect** on the Bluetooth settings screen. If you do not want to use your phone with Model Y again, touch **Forget This Device**. Once you forget a device, you need to pair it again if you want to use it with Model Y (see [Pairing a Bluetooth Phone](#) on page 141).

**Note:** Your phone automatically disconnects whenever you leave Model Y.



**Note:** Unpairing the phone has no effect on using the phone as a key. To forget an authenticated phone, see [Keys](#) on page 9.

## Connecting to a Paired Phone

Model Y automatically connects with the last phone to which it was connected, provided it is within operating range and has Bluetooth turned on. If the last phone is not within range, it attempts to connect with the next phone that it has been paired with.

To connect to a different phone, touch the Bluetooth icon on the top of the touchscreen. The Bluetooth window displays a list of paired phones. Choose the phone you want to connect to, then touch **Connect**. If the phone you want to connect to is not listed, you must pair the phone. See [Pairing a Bluetooth Phone](#) on page 141.

When connected, the Model Y touchscreen displays the Bluetooth symbol next to the phone name to show that the connection is active.

## Using the Phone App

When your phone is connected to Model Y using Bluetooth, and you have allowed access to your phone's contacts (see [Importing Contacts and Recent Calls](#) on page 141), you can use the phone app to display and make a hands-free call to anyone listed on your phone:

- **Recent Calls** list. The list displays calls in chronological order with the most recent call listed first. You can display all calls or just those that are missed, incoming, or outgoing.
- **Contacts**: Contacts are listed in alphabetical order and can be sorted by first name or last name. You can also choose a letter on the right side of the list to quickly scroll to the names that begin with the selected character. When you touch a name on your contacts list, the contact's available number(s) displays on the right pane, along with other available information (such as address). Touch the contact's number to make a call.

You can also view, send, and receive text messages on the touchscreen. Instead of typing a text message, touch the microphone to enter text using your voice.

**Warning:** To minimize distraction and ensure the safety of vehicle occupants as

well as other road users, do not view or send text messages when the vehicle is in motion. Pay attention to road and traffic conditions at all times when driving.

## Making a Phone Call

You can make a phone call by:

- Speaking a voice command (see [Using Voice Commands](#) on page 144).
- Choosing a number from your contact or recent calls list in the phone app.
- Using the Model Y on-screen dialer in the phone app.

**Note:** If it is safe and legal to do so, you can also initiate a call by dialing the number or selecting the contact directly from your phone.

**Note:** You can also make a phone call by touching a pin on the map and choosing the phone number (if available) on the popup window.

## Receiving a Phone Call

When your phone receives an incoming call, the touchscreen displays the caller's number or name (if the caller is in your phone's contact list and Model Y has access to your contacts).

Touch one of the options on the touchscreen to **Answer** or **Ignore** the call.

**Note:** Depending on the phone you are using and what speakers you used for your most recent call, your phone may prompt you to choose which speakers you want to use for the incoming call.

**Warning:** Stay focused on the road at all times while driving. Using or programming a phone while driving, even with Bluetooth enabled, can result in serious injury or death.

**Warning:** Follow all applicable laws regarding the use of phones while driving, including, but not limited to, laws that prohibit texting and require hands-free operation at all times.



## Overview

The Calendar app allows you to view scheduled events from your phone's (iPhone® or Android™) calendar for the current and next day. The Calendar is conveniently integrated with navigation and the Phone app so you can navigate to, or dial into, your next meeting. The Calendar app requires that:

- The Tesla mobile app is running, you are logged in, and the Calendar Sync setting is enabled. The mobile app can then periodically (and automatically) send calendar data from your phone to Model Y.

**Note:** To ensure you have access to all features of the Calendar app, it is recommended that you use the most recent version of the mobile app.

- Your phone is connected to Model Y via Bluetooth (for privacy reasons, calendar data displays only from a connected phone).
- Mobile access to Model Y is turned on (touch **Controls** > **Safety & Security** > **Allow Mobile Access**).
- Both your phone and Model Y have good connectivity.

When you enter Model Y, the touchscreen can display a reminder of the day's events. You can customize if and when your calendar events are displayed by touching the settings icon located in the top left corner of the Calendar app, then choosing from one of the options available for the **Show Calendar Upon Entry** setting.

If a calendar event includes an address, a navigation arrow displays to indicate that you can touch the address to navigate to the event's location. When an event on your Calendar takes place within the next hour and has a uniquely specified address, the touchscreen notifies you if there is a better route due to traffic, even when you're not currently using navigation.

If an event has a uniquely specified address and takes place within two hours of you entering your vehicle and preparing to drive, Model Y will automatically route you to the event's address (see [Automatic Navigation](#) on page 134).

Touch an event's information icon to display all notes associated with the event. If the notes include one or more phone numbers, the information icon shows a phone icon and the calendar displays the first phone number found. Touch to initiate a phone call. You can also initiate a phone call by touching any number in an event's notes popup window (this is especially useful for conference calls). If the notes contain a web link, you can touch the link to open it in the web browser (if equipped).

If events are displayed from multiple calendars, touch the list icon in the top right corner to filter the list of events to show only those from one or more specified calendars.





Voice commands are designed to understand natural requests. You can use voice commands to:

- Call a contact.
- Navigate to a location.
- Listen to Internet music.
- Control various aspects of Model Y.



To initiate a voice command, tap the microphone button on the touchscreen. When you hear the tone, speak your command. As you speak, the touchscreen displays an interpretation of your command. It also displays tips to remind you of the type of commands you can speak. When you finish speaking the command, tap the voice button again or simply wait.

**Note:** Voice commands may be spoken in English or French (Canada).

**Note:** You can also initiate a voice command by pressing the right scroll button.

- To call a contact on your Bluetooth-connected phone, say “Call” or “Dial”, followed by the contact’s first and/or last name(s). For example, “Call Joe” or “Call Joe Smith”.
- To search for, or navigate to, a location, say “Where is”, “Drive to”, or “Navigate to”, followed by an address, business name, business category, or landmark. For example, “Where is Stanford University?”, “Drive to Tesla in Palo Alto”, or “Navigate to Starbucks on Homestead in Cupertino”. If you have defined a navigation address for your home or work locations, you can use a voice command to navigate there by saying “Navigate home” or “Navigate to work”.
- To listen to an Internet music service, say “Listen to” or “Play”, followed by the name of the song, album, artist, or combination. To improve voice recognition accuracy, provide multiple cues in your command, such as artist plus song (for example, “Listen to Yellow Brick Road” or “Play Yellow Brick Road by Elton John”).
- Control various aspects of Model Y by speaking statements or commands. For example, “Speed up the wipers”, “The screen is too bright!”, “Turn on the driver’s seat heater”, “I’m cold”.

**Note:** Tesla is continuously improving the ability of Model Y to recognize voice

commands. To support these ongoing quality improvements, Tesla captures short voice recordings anonymously. To protect your privacy, these short recordings are not associated with your personal information or with your vehicle’s identification number. Tesla assures that it is not possible to search any system for a recording associated with a specific customer or vehicle.



## About the Security System

If Model Y does not detect an authenticated phone, key fob, or key card and a locked door or trunk is opened, an alarm sounds and the headlights and turn signals flash. To deactivate the alarm, press any button on the mobile app or tap your key card or key fob against the card reader located approximately one third the way up of the driver's side door pillar.

To manually enable or disable the alarm system, touch **Controls > Safety & Security > Security Alarm**. When enabled, Model Y activates its alarm one minute after you exit, the doors lock, and a recognized key is no longer detected.

If your Model Y is equipped with the security package, a battery-backed siren sounds in situations where a locked door or trunk is opened and Model Y does not detect a key nearby. If you also want this siren to sound in situations where Model Y detects motion inside the cabin, or is moved or tilted (for example, with a tow truck or jack), turn on the **Tilt/Intrusion** setting (**Controls > Safety & Security > Tilt/Intrusion**).

**Note:** If you plan to leave something that moves inside your locked Model Y, remember to turn off **Tilt/Intrusion** (if equipped). If this setting is on, any motion detected inside Model Y activates the intrusion alarm.

**Note:** The **Security Alarm** must be on to enable **Tilt/Intrusion**.

**Note:** The Intrusion Sensor automatically disables in situations where the climate control system is operating when you have left your vehicle (see [Keep Climate On, Dog Mode, and Camp Mode](#) on page 130). To override, you can manually turn the Intrusion Sensor on again after choosing **Keep Climate On, Dog, or Camp Mode** (touch **Controls > Safety & Security > Tilt/Intrusion**).

## PIN to Drive

To increase security, you can prevent Model Y from being driven until a 4-digit PIN (Personal Identification Number) is entered. To enable this setting, touch **Controls > Safety & Security > PIN to Drive** and follow the on-screen prompts to create a driving PIN.

**Note:** When enabled, in addition to entering the 4-digit driving PIN to drive, you must also use it to enter Valet mode for the first time and create the 4-digit valet PIN that you can use to enter and exit Valet mode. When in Valet mode, Model Y can be driven without

the need for the valet to enter a driving PIN. In addition, the **PIN to Drive** setting is disabled whenever Valet mode is active.

If you forget your driving PIN, or to disable **PIN to Drive**, return to this setting, touch the link to enter your Tesla login credentials, then follow the on-screen prompts.

**Note:** In the unlikely event that your touchscreen is unresponsive, you may be unable to enter the PIN. In this case, first try to restart the touchscreen (see [Restarting the Touchscreen](#) on page 56). If the touchscreen is still unresponsive, you can still bypass PIN to Drive by turning on Keyless Driving in the Tesla mobile app.

## Sentry Mode

In Sentry Mode, cameras and sensors remain powered on and ready to record suspicious activity whenever Model Y is locked and in Park.

To turn Sentry Mode on or off, touch the Sentry Mode icon at the top of your touchscreen. Alternatively, you can use voice commands, the mobile app, or you can touch **Controls > Safety & Security > Sentry Mode**. To activate Sentry Mode using voice commands, say "Keep Tesla safe", "Keep my car safe", "Sentry on", or "Enable Sentry" (for details using voice commands, see [Using Voice Commands](#) on page 144).

**Note:** Sentry Mode requires the Battery to be at least 20% charged. If the Battery falls below 20%, Sentry Mode turns off and the mobile app sends you a notification.

**Note:** Power consumption may increase when Sentry Mode is active.

**Note:** Software updates cannot be installed when Sentry Mode is activated.

**Warning:** Do not rely on Sentry Mode to protect Model Y from all possible security threats. While it may help deter some threats, no security system can prevent all attacks.

## Standby, Alert, and Alarm States

When in Sentry Mode, Model Y may go through three states depending on its surroundings—Standby, Alert, and Alarm:



- **Standby** - Your vehicle automatically enters the Standby state when you activate Sentry Mode. In the Standby state, the cameras constantly monitor the area surrounding Model Y for possible security threats.
- **Alert** - If Sentry Mode detects a threat, such as someone leaning on Model Y, Sentry Mode switches to the Alert state. The headlights flash and the touchscreen displays a message indicating that the cameras are recording the event.
- **Alarm** - For major threats, such as someone breaking a window, Sentry Mode triggers the Alarm state. In the Alarm state, the security alarm activates, the audio system generates a loud and unexpected sound, and the message on the touchscreen displays at maximum brightness. Sentry mode sends an alert to the mobile app on phones that are paired to Model Y to inform you that the alarm state is triggered. After 30 seconds, Sentry Mode returns to the Standby state.

When in the Alert or Alarm state, Sentry Mode saves the most recent ten minutes of footage prior to the event that triggered either state, provided that a properly configured USB flash drive is inserted into one of the USB ports (see [USB Flash Drive Requirements for Videos and Recording](#) on page 146).

**Note:** When the Alarm state is triggered, the most recent six seconds prior to the security event may be sent to Tesla for temporary backup for approximately 72 hours. You can enable or disable the collection of this video at any time by touching **Controls > Safety & Security > Data Sharing**.

**Note:** Sentry Mode can operate without a flash drive installed. If your vehicle enters the Alarm state, the security alarm activates and Sentry Mode sends an alert to your phone. However, video recordings of the event are not available.

## Location-Based Settings

You can customize Sentry Mode to automatically activate at specific locations where you park Model Y:

- **Exclude Home** - When on, Sentry Mode does not automatically activate at the location you set as Home in your Favorites list (see [Recent, Favorite, Home and Work Destinations](#) on page 136), but activates at any other parking location.

**Note:** To set up your Home location, touch **Navigate** and hold down **Home**, then enter your address. Touch **Save as Home**.

- **Exclude Work** - When on, Sentry Mode does not automatically activate at the location you set as Work in your Favorites list, but activates at any other parking location. Set your Work location the same way you set up your Home location, as previously described.
- **Exclude Favorites** - When on, Sentry Mode does not automatically activate at any location in your Favorites list, but activates at any other parking location.

To recognize a location listed as Home, Work, or a Favorite, Sentry Mode requires that Model Y is parked within 32 feet (10 meters) of the location listed as a Home, Work, or Favorite.

## USB Flash Drive Requirements for Videos and Recording

To store video from your vehicle's cameras, follow these requirements and guidelines for using flash drives:

- The flash drive must have a sustained write speed of at least 4 MB/s. A sustained write speed is different from the peak write speed. Check the product details of your flash drive for more information.
- The flash drive must be USB 2.0 compatible. If using a USB 3.0 flash drive, it must be able to support USB 2.0.
- Use a dedicated flash drive exclusively for saving Sentry Mode recordings.
- The flash drive must be properly formatted (see [Formatting the USB Flash Drive](#) on page 147).
- Use a flash drive with as much available storage as possible. Video footage can occupy a large amount of space. Tesla recommends using a flash drive with at least 32 GB of storage. Some personal computer operating systems may be unable to format flash drives larger than 32 GB as FAT 32. Consider using a third party application to format flash drives larger than 32 GB.



Although not a comprehensive list, Tesla has testing the following flash drives and confirmed that they meet the requirements for using Dashcam and Sentry Mode:

- SanDisk Ultra Fit USB 3.1 Flash Drive
- Samsung MUF-64AB/AM FIT Plus - 200MB/s USB 3.1 Flash Drive

### Formatting the USB Flash Drive

To correctly save and retrieve video footage, Model Y requires the USB flash drive to be formatted as FAT 32 (for Windows), MS-DOS FAT (for Mac), ext3, or ext4. NTFS and exFAT are not currently supported. In addition, the USB flash drive must contain a base-level folder called “TeslaCam” (without quotation marks). Follow the steps below to prepare a USB flash drive.

#### For MacOS:

1. Insert the USB flash drive into your personal computer.
2. Navigate to **Utilities > Disk Utility** (or conduct a Spotlight Search).
3. Select your flash drive in the left menu.
4. Navigate to **Erase** in the top menu ribbon.
5. In the pop-up menu, select the correct format (MS-DOS FAT) and click **Erase**.

**Note:** Selecting **Erase** removes all existing content from your flash drive. If you have content that you want to keep, you must move it to a different device before erasing.

6. Once the flash drive is successfully erased, navigate to **Finder** and select your USB flash drive from the left menu. The flash drive should not contain any files.
7. Right-click in the empty space of the flash drive and select **New Folder**. A folder appears in your flash drive space.
8. Right-click on the folder, select **Rename**, and name the folder to “**TeslaCam**” (without quotation marks). Click “Save”. This folder will contain all recent and saved clips from Sentry Mode and dashcam.
9. Properly eject the USB flash drive.

#### For Windows:

1. Insert the USB flash drive into your personal computer.
2. Navigate to **File Explorer**.
3. Right-click on your USB flash drive and select “Format...”.

4. In the pop-up menu, under the File System section, select “FAT 32”.

**Note:** You can also name your USB flash drive (under Volume Label) for easier recognition.

5. Check the **Quick format** box and click **Start**.
6. Go back to File Explorer, click on your flash drive, and right-click to create a folder, or select **New Folder** in the top menu.
7. Name the folder “**TeslaCam**” (without quotation marks) and click **Save**. This folder will contain all recent and saved clips from Sentry Mode and dashcam.
8. Properly eject the USB flash drive.

Once you have formatted the USB flash drive and created the **TeslaCam** folder, insert it into one of the front USB ports in Model Y. Do not use the rear USB ports—they are for charging only. It may take Model Y up to 15 seconds to recognize the flash drive. When recognized, icons for dashcam and Sentry Mode appear at the top of your touchscreen (note that you may need to enable Sentry Mode by touching **Controls > Safety & Security > Sentry Mode**). Model Y is ready to record video.

#### Retrieving Footage

To retrieve video footage from the USB flash drive, remove the flash drive from the front USB port and use a personal computer or other device to access the files. Navigate to the **TeslaCam** folder.

Within the **TeslaCam** folder, there are three sub-folders:



- **Recent Clips** - The footage in Recent Clips continuously loops in 60-minute cycles whenever the cameras are activate. Therefore, footage is constantly overwritten every hour unless you save it. When an event is recorded, one video is recorded for each of the front, rear, left, and right cameras.
- **Saved Clips** - Contains all recordings that you have manually saved using **Dashcam** on page 78.
- **Sentry Clips** - Contains all footage from Sentry Mode events which have been automatically saved when an Alert or Alarm state is triggered. The last 10 minutes of an event's footage is saved and labeled with a unique timestamp.

**Note:** As the USB flash drive runs out of available space, the oldest footage in Sentry Clips is deleted to make room for new footage. Once deleted, you will be unable to retrieve them. When the flash drive is full, Sentry Mode and Dashcam can no longer save video footage. To prevent the flash drive from getting full, you must regularly move saved videos to another device, and delete them from the flash drive.

**Note:** You are responsible for complying with all local laws, regulations, and property restrictions regarding video recordings.

**Note:** The cameras do not record audio.

## Save Clips on Honk

Once a properly formatted USB flash drive is inserted in one of the vehicle's front USB ports, you can choose to save dashcam clips while driving when you honk the horn on your steering wheel. Navigate to **Controls > Safety and Security > Save Clips on Honk > ON** to enable. The most recent ten minutes of footage is saved. You can also save dashcam footage by touching the dashcam icon at the top of the touchscreen.



## About HomeLink

If your vehicle is equipped with the HomeLink® Universal Transceiver, you can operate up to three Radio Frequency (RF) devices, including garage doors, gates, lights, and security systems.

**Note:** Depending on date of manufacture, market region, and options selected at time of purchase, some vehicles are not equipped with a HomeLink Universal Transceiver.

**Warning:** Do not use the HomeLink Universal Transceiver with a device that does not have safety stop and reverse features. Using a device without these safety features increases the risk of injury or death.

## Supported Modes

HomeLink supports three different transmit modes, which is how your vehicle and the RF device communicate. Selecting a transmit mode is determined by your RF device's compatibility:

- **Standard Mode:** Use Standard Mode if your RF device is equipped with a remote and the remote must be used to operate the device (for example, a remote-controlled garage door). This is the most common mode used with devices.
- **D-Mode or UR-Mode:** Use D-Mode or UR-Mode if the RF device does not have a remote, and the receiver has a "Learn" button (may also be called "Program" or "Smart"). D-Mode and UR-Mode function similarly because the vehicle directly communicates with the device's receiver, so you don't have to pair a remote.

**Note:** D-Mode is used mainly in North America while UR-Mode is popular in Europe, the Middle East, and Asia. To determine with which mode your device is compatible, contact HomeLink ([www.homelink.com](http://www.homelink.com) or call 1-800-355-3515).

Each of your devices can be set to a different mode. For example, your garage door can be set to Standard Mode, your front gate can be set to D-Mode, etc. To change a transmit mode, touch the HomeLink icon on the touchscreen's status bar and select the device you want to change. Then, select **Program** and choose the desired mode for your device. Confirm by touching **Set Mode** and follow the onscreen instructions.

For older vehicles, changing the mode for one device changes the mode for all devices, so be careful when changing transmit modes.

Devices not compatible with your selected mode may not work. Touch the HomeLink icon on the touchscreen's status bar and touch **Change Transmit Mode**.

**Note:** Check the product information for your garage door, gate, light, etc. to determine which mode is compatible with your device.

## Programming HomeLink®

To program HomeLink® (if equipped):

1. Park Model Y so that the front bumper is in front of the garage door, gate, or light you want to program.
  - Caution:** Your device might open or close during programming. Before programming, make sure that the device is clear of any people or objects.
2. Get the device's remote control and ensure it has a healthy battery. Tesla recommends replacing the battery in the device's remote control before Programming HomeLink.
3. Touch the HomeLink icon at the top of the touchscreen.
4. Touch **Create HomeLink**, then select which mode you wish to use: Standard, D-Mode, or UR-Mode.
5. Use the touchscreen to enter a name for your device and touch **Enter** or **Create HomeLink**.
6. Touch **Start** then follow the onscreen instructions.
 

**Note:** If you see a screen called "Train the receiver" while programming the device, remember that this is a time-sensitive step. After pressing the Learn/Program/Smart button on the device's remote, you only have approximately 30 seconds to return to your vehicle, press **Continue**, and then press the trained HomeLink device name twice. Consider having an assistant help with this step.
7. Once your device is programmed, touch **Save** to complete the HomeLink programming routine.
8. Ensure HomeLink works as expected. In some cases the programming process may require multiple attempts before succeeding.



Once programmed, you can operate the device by touching its corresponding HomeLink icon on the touchscreen's status bar. HomeLink remembers the location of your programmed devices. When you approach a known location, the HomeLink control on the touchscreen automatically drops down. When you drive away, it disappears.

**Note:** For additional assistance or compatibility questions, contact HomeLink ([www.homelink.com](http://www.homelink.com) or call 1-800-355-3515).

## Auto Opening and Closing

To operate a HomeLink device without touching the touchscreen, you can automate the device to open as you approach, and close as you drive away:

1. Touch the HomeLink icon at the top of the touchscreen and choose the device you want to automate.
2. Select the **Auto-open when arriving** checkbox if you want the device to open as you approach.
3. Touch the arrows to specify the distance you want your vehicle to be from the device before it opens.
4. Select the **Auto-close when leaving** checkbox if you want the device to close as you drive away.

As you approach (or drive away from) a device that is set to operate automatically, the HomeLink status icon displays a count-down message to let you know when the device will automatically open or close. In situations where you don't want the device to automatically open or close, touch **Skip Auto-Open** or **Skip Auto-Close** at any time during the count-down message.

## Resetting the Location of the HomeLink Device

If you experience situations in which you sometimes drive up to your HomeLink device and it doesn't open, or the HomeLink icon on the touchscreen's status bar does not display the dropdown when you approach the device, you may need to reset the device's location. To do so, park as close as possible to the HomeLink device (garage door, gate, etc.) and display the HomeLink settings page by touching the HomeLink icon at the top of the touchscreen. Touch the name of the device you want to reset, then **Reset Location**.

## Deleting a Device

To delete a HomeLink device, touch the HomeLink icon at the top of the touchscreen. Touch the name of the device you want to delete, then touch **Delete**.

**Note:** You can also perform a factory reset to erase your HomeLink settings, along with all other personal data (saved addresses, music favorites, imported contacts, etc.). See [Erasing Personal Data](#) on page 126.

**Note:** For security reasons, delete your HomeLink devices if you sell your Model Y.

## Troubleshooting HomeLink

### Standard Mode

In Standard Mode, Model Y records the signal from the remote of your RF device. The touchscreen instructs you to stand in front of the vehicle, point the remote at the front bumper, and press and hold the button until the headlights flash. When the headlights flash, Model Y has learned the remote and you can touch **Continue** on the touchscreen. If the headlights do not flash, refer to the following guidelines:

- Check the batteries in the remote. It is a good idea to replace the batteries before you start programming.
- While standing in front of your vehicle, press and hold the button on your device's remote, with the remote approximately 2 inches (5 cm) in front of the Tesla emblem. In some cases you must hold the button on the remote for up to three minutes.
- Certain garage door remotes may require multiple short remote presses (approximately 1 second each press) instead of one long duration press.

### D-Mode and UR-Mode

In D Mode and UR-Mode, the device's receiver learns Model Y. The touchscreen instructs you to press the "Learn" button (may also be called "Program" or "Smart") on the device's receiver. If this does not work, refer to the following guidelines:

- Park Model Y with its bumper as close as possible to the garage door, gate, etc. that you are trying to program.



- Make sure you are pressing the receiver's Learn/Program/Smart button. For instructions on how to put the receiver into learning mode, refer to the product details provided with your RF device that you are trying to program.
- If you see a screen called "Train the receiver" while programming the device, remember that this is a time-sensitive step. After pressing the Learn/Program/Smart button on the device's remote or receiver, you only have approximately 30 seconds to return to your vehicle, press **Continue**, then press the trained HomeLink device name twice. Consider having someone assist you with this step.
- Most devices stay in learning mode for only three to five minutes. Immediately after pressing the device's Learn/Program/Smart button, follow the instructions displayed on the vehicle's touchscreen.

For additional assistance or compatibility questions, contact HomeLink ([www.homelink.com](http://www.homelink.com) or call 1-800-355-3515).





Wi-Fi is available as a data connection method and is often faster than cellular data networks. Connecting to Wi-Fi is especially useful in areas with limited or no cellular connectivity. To ensure fast, reliable delivery of software and map updates, Tesla recommends leaving your vehicle connected to a Wi-Fi network whenever possible (for example, if parked in your garage overnight).

To connect to a Wi-Fi network:

1. Touch the cellular icon (usually **LTE** or **3G**) on the top corner of your touchscreen. Model Y will start scanning and display the detected Wi-Fi networks that are within range.
2. Select the Wi-Fi network you want to use, enter the password (if necessary), then touch **Confirm**.
3. Your vehicle connects to the Wi-Fi network and will automatically connect to it whenever the network is within range.

You can also connect to a hidden network that isn't shown on the list of scanned networks.

Just touch **Wi-Fi Settings**, enter the name of the network in the resulting dialog box, select the security setting, then touch **Add Network**.

**Note:** If more than one previously connected network is within range, Model Y connects to the one most recently used.

**Note:** You can also use a mobile hotspot or your phone's Internet connection via Wi-Fi tethering (subject to fees and restrictions of your mobile carrier).

**Note:** At Tesla Service Centers, Model Y automatically connects to the Tesla Service Wi-Fi network.



## Loading New Software

Tesla updates your vehicle's software wirelessly, constantly providing new features. Tesla recommends you install software updates as soon as they are available on your vehicle. To ensure the fastest and most reliable delivery of software updates, leave Wi-Fi turned on and connected whenever possible. In most cases, your vehicle must be connected to Wi-Fi to start an update (see [Connecting to Wi-Fi](#) on page 152).

**Note:** On an as-needed basis, Tesla also sends software updates using a cellular connection.

**Note:** Software updates are not performed when Keep Climate On, Dog Mode, or Camp Mode is active.

**Warning:** Do not attempt to use the vehicle while the software is being updated. Vehicle functions, including some safety systems, may be limited or disabled when a software update is in progress and you could damage the vehicle.

When a software update is available, a yellow clock icon appears at the top of the touchscreen. There are three ways you can install software updates:

- Touch the yellow clock icon to display the scheduling window, which prompts you to select a time to install the update (**SET FOR THIS TIME**) or install it now (**INSTALL NOW**). Once scheduled, the yellow clock icon changes to a white clock icon until the update begins. At any time before the update begins, you can touch this clock icon to reschedule the update.
- Go to **Controls > Software** to determine if an update is available for your vehicle. If available, touch **Software Update Available** to navigate to the scheduling window, as mentioned above.
- Start updates using the Tesla mobile app.

**Note:** Some software updates can take up to three hours to complete. Model Y must be in Park while the software is being updated. To ensure the fastest and most reliable delivery of software updates, leave the Wi-Fi turned on and connected whenever possible (see [Connecting to Wi-Fi](#) on page 152).

The yellow clock icon becomes a green download icon when a software update is downloading. If a yellow download icon displays, a software update is available but your vehicle is not connected to Wi-Fi. Connect your vehicle to Wi-Fi to start the download.

## Software Update Preferences

You can choose how quickly and often you receive software updates. To change your preference, navigate to **Controls > Software > Software Update Preferences** and choose either of these options:

- **STANDARD:** Receive software updates using the normal rollout timeframe for your region and vehicle configuration. When a software release is made available it has generally been running on other customer vehicles for a period of time.
- **ADVANCED:** Receive the latest software updates for your region and vehicle configuration as soon as they are available. Tesla determines how, when, and where to send updates to vehicles based on various factors unique to each release. Keep in mind that although you receive updates as soon as they are available for your specific vehicle, you may not be in the first Tesla group of Tesla owners to receive the update. Choosing Advanced does not enroll your vehicle in Tesla's early access program.

**Note:** Tesla does not update software upon request for those wanting to receive the latest features and improvements. Selecting **ADVANCED** and consistently connecting to Wi-Fi (see [Connecting to Wi-Fi](#) on page 152) is the best way to receive the latest software updates.

**Note:** The software update window persists until you install the update. You must install a software update as soon it becomes available. Any harm resulting from failure to install a software update is not covered by the vehicle's warranty. Failure or refusal to install updates can cause some vehicle features to become inaccessible, digital media devices to become incompatible, and can limit Tesla's ability to diagnose and service your vehicle.

**Note:** Reverting to a previous software version is not possible.

If the touchscreen displays a message indicating that a software update was not successfully completed, contact Tesla.



## Charging

If Model Y is charging when the software update begins, charging stops. Charging resumes automatically when the software update is complete. If you are driving Model Y at the scheduled update time, the update is canceled and must be rescheduled.

## Viewing Release Notes

When a software update is complete, read the release notes displayed on the touchscreen to learn about changes or new features. To display release notes about the current version of your vehicle's software at any time, touch the Tesla "T" at the top center of the touchscreen, then touch **Release Notes**. You can also view the release notes by touching **Controls > Software**.

Tesla strongly recommends reading all release notes. They may contain important safety information or operating instructions for your Model Y.



The Tesla mobile app allows you to communicate with Model Y remotely using your iPhone® or Android™ phone.

## To use the mobile app

To set up the Tesla mobile app to communicate with your Model Y:

1. Download the Tesla mobile app to your phone.
2. Log in to the Tesla mobile app by entering your Tesla account credentials.
3. Enable mobile access to your Model Y by touching **Controls** > **Safety & Security** > **Mobile Access** (see [Controls](#) on page 118).
4. Turn your phone's Bluetooth setting **ON** and ensure that Bluetooth is turned on within your phone's global settings for the Tesla mobile app if you want to use an authenticated phone as a key. For example, on your phone, navigate to Settings, choose the Tesla mobile app, and ensure the Bluetooth setting is enabled.

Your smartphone and vehicle must both be actively connected to cellular service to allow the mobile app to communicate with your vehicle. Tesla recommends that you always have a functional physical key readily available if parking in an area with limited or absent cellular service, such as an indoor parking garage.

If multiple vehicles are linked to the Tesla Account, you must switch to the Model Y you want to access in the mobile app before the phone can be used as a key. Swipe left or right to change vehicles.

**Note:** In the event that you require lockout assistance from Tesla due to a non-warranty issue, such as having limited cellular connectivity and having no secondary key available, your expenses are not covered under the Roadside Assistance policy.

**Note:** Tesla does not support the use of third party applications to contact Model Y.

## Overview

The Tesla mobile app's home screen allows you to:

- See the name of your vehicle (if you have one)
- View your vehicle's estimated range.
- See which gear the vehicle is in (driving, park, etc.).

- Enable maximum defrost to warm your vehicle in cold conditions.
- Enable keyless driving.
- Open the front trunk.
- Lock or unlock your vehicle.
- At the bottom, view your vehicle's odometer, VIN, and firmware version it is currently running.

For supported video sources, send videos to play in the Tesla Theater by sharing the link through the mobile app. Navigate to the movie, show, or video you want to play on your smartphone and touch the share button. Share the video with the Tesla app and it will appear on your vehicle's touchscreen if Model Y is in Park.

## Phone Key

Set up your phone as the key (as described in [Authenticated Phone](#) on page 9). Once authenticated, your phone's Bluetooth signal is detected as you approach your vehicle and the doors unlock when you press a door handle. Likewise, when you exit and walk away with the phone, doors automatically lock (provided the **Walk-Away Door Lock** feature is turned on, as described in [Walk-Away Door Lock](#) on page 15). You must be near your vehicle and have a key card ready to set up your smartphone as a phone key.

**Note:** You should always carry a key card or fob in the event you park somewhere with inadequate cell service.

## Climate

Check the interior temperature and heat or cool the cabin before driving (even if it's in a garage). You can also turn the seat heaters on (see [Seat Heaters](#) on page 31) and defrost the windshield by touching the windshield defrost icon at the bottom.

**Turn Climate On:** This allows you to precondition the cabin by moving the direction of air flow from the vents, and turning on or off the steering wheel and seat heaters.

**Note:** It is possible that your charge port latch may freeze in place in extremely cold weather or icy conditions. In cases where you cannot remove or insert the charge cable, or the vehicle is not Supercharging due to the latch being frozen in place, use your Tesla mobile app to precondition your vehicle on **HI** for approximately 30-45 minutes (you must use



your mobile app to precondition the vehicle; setting your climate to **HI** using the touchscreen will not be effective). This helps thaw ice on the charge port latch so the charge cable can be removed or inserted.

## Controls

The Controls tab allows you do the following:

- Vent or close the windows.
- Lock or unlock Model Y from afar.
- Flash the lights or honk the horn to find where Model Y is parked.
- Enable Keyless Driving.

**Note:** Keyless Driving can be used when you do not have your key or to bypass PIN to Drive in cases where you forgot your PIN or your touchscreen is unresponsive (see [PIN to Drive](#) on page 145).

- Open the front or rear trunk.
- Open and close your garage door if your vehicle has a programmed HomeLink connection, if available (see [HomeLink Universal Transceiver](#) on page 149).
- Enable or disable valet mode (see [Valet Mode](#) on page 51).
- Enable/disable Sentry Mode (see [Sentry Mode](#) on page 145).
- Enable/disable Speed Limit Mode and receive notifications when the vehicle's driving speed is within approximately 3 mph (5 km/h) of your selected maximum speed (see [Speed Limit Mode](#) on page 126).

## Charging

Check charging progress, stop charging, and receive notifications when charging is started, interrupted, almost complete, or complete. You can also view nearby chargers and send the directions to your vehicle's touchscreen.

**Note:** When Supercharging, additional notifications alert you when you will be charged idle fees for parking at a supercharger after charging is complete. The idle fees are waived if your vehicle is moved within five minutes of when the vehicle finishes charging. See [Supercharger Usage Fees and Idle Fees](#) on page 167.

## Location

Locate Model Y with directions, or track its movement across a map.

## Summon

You can park or retrieve Model Y using Summon (see [Summon](#) on page 103) or Smart Summon (see [Smart Summon](#) on page 106) , if equipped.

## Upgrades

View and purchase the latest upgrades available for your vehicle, such as full self-driving.

## Schedule Service

Scheduling a service visit through the mobile app is easy. After touching **Schedule Service**, select the type of service needed and follow the directions in the mobile app. Provide as much detail as possible, such as:

- Photos, sound recordings, or videos.
- Date(s), time(s), and time zone when the issue occurred.
- Country of use and location.
- Approximate speed the vehicle was traveling (if applicable).
- Environmental conditions (rain, snow, cold, etc.).
- Road name and type of road (if applicable).
- Quality of lane markings (if applicable).
- Applicable vehicle settings.
- Identifiable symptoms.

## Settings

In this settings tab located at the top corner of your smartphone's screen (shown as a gear icon), you can:

- Switch to a different vehicle associated with your Tesla account, if you have access to more than one.
- Access the Tesla inbox.
- View Notifications and customize the notifications you receive, such as when your security alarm has been triggered, charging updates, and new software updates. You can start them from afar and check its progress.
- Enable or disable Touch ID.
- Support the Model Y Calendar app on the touchscreen by allowing the mobile app to send your phone's calendar data to your vehicle.



**Note:** Some of these features require installation of the latest version of the mobile app.

**Note:** The above list may not represent an exhaustive list of the functions available on the Tesla mobile app. To ensure access to new and improved features, download updated versions of the mobile app as they become available.



## High Voltage Components

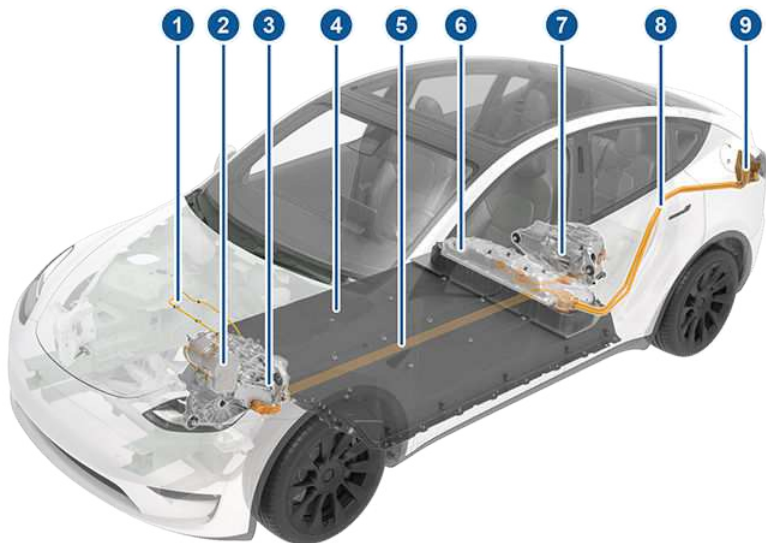

1. High Voltage Cabling
2. Heat Pump
3. Front Motor (Dual Motor vehicles only)
4. High Voltage Battery
5. High Voltage Cabling
6. High Voltage Battery Service Panel
7. Rear Motor
8. High Voltage Busbars
9. Charge Port

**Warning:** The high voltage system has no user serviceable parts. Do not disassemble, remove or replace high voltage components, cables or connectors. High voltage cables are typically colored orange for easy identification.

**Warning:** Read and follow all instructions provided on the labels that are attached to Model Y. These labels are there for your safety.

**Warning:** In the unlikely event that a fire occurs, immediately contact your local fire emergency responders.



## Charging Equipment

Charging equipment designed specifically to charge your Model Y is available from Tesla. A Tesla Wall Connector, which installs in your garage, is the fastest way to charge Model Y at home.

In most market regions, Model Y is equipped with a Mobile Connector and the adapter(s) needed to plug into the most commonly used power outlets. When using the Mobile Connector, first plug the Mobile Connector into the power outlet, and then plug in Model Y. For more information about your Mobile Connector, see the Mobile Connector Owner's Manual (available on the touchscreen). Additional adapters can be purchased from Tesla.

Tesla offers adapters (for example, J1772 and CHAdeMO) to allow you to plug into the most commonly used public charging stations in your region. Open the charge port door using the touchscreen (see [Charging Instructions](#) on page 162), plug the adapter into the charging port on Model Y, and then connect the station's charging connector to the adapter. For information on the charging equipment available for your region, go to [www.tesla.com](http://www.tesla.com), choose your region, and then view the available charging options.

More details on public charging station adapters is available at <https://www.tesla.com/chademo>.





## About the Battery

Model Y has one of the most sophisticated battery systems in the world. The most important way to preserve the Battery is to **LEAVE YOUR VEHICLE PLUGGED IN** when you are not using it. This is particularly important if you are not planning to drive Model Y for several weeks. When plugged in, Model Y wakes up when needed to automatically maintain a charge level that maximizes the lifetime of the Battery.

**Note:** When left idle and unplugged, your vehicle periodically uses energy from the Battery for system tests and recharging the 12V battery when necessary.

There is no advantage to waiting until the Battery's level is low before charging. In fact, the Battery performs best when charged regularly.

**Note:** If you allow the Battery to discharge to 0%, other components may become damaged or require replacement (for example, the 12V battery). In these cases, you are responsible for repair and/or transporting expenses. Discharge-related expenses are not covered by the warranty or under the Roadside Assistance policy.

The peak charging rate of the Battery may decrease slightly after a large number of DC Fast Charging sessions, such as those at Superchargers. To ensure maximum driving range and Battery safety, the Battery charge rate is decreased when the Battery is too cold, when the Battery's charge is nearly full, and when the Battery conditions change with usage and age. These changes in the condition of the Battery are driven by battery physics and may increase the total Supercharging duration by a few minutes over time.

## Battery Care

Never allow the Battery to fully discharge. Even when Model Y is not being driven, its Battery discharges very slowly to power the onboard electronics. The Battery can discharge at a rate of approximately 1% per day, though the discharge rate may vary depending on environmental factors (such as cold weather), vehicle configuration, and your selected settings on the touchscreen. Situations can arise in which you must leave Model Y unplugged for an extended period of time (for example, at an airport when traveling). In these situations, keep the 1% in mind to ensure that you leave the Battery with a sufficient charge level. For example, over a two week period (14 days), the Battery may discharge by approximately 14%.

Discharging the Battery to 0% may result in damage to vehicle components. To protect against a complete discharge, Model Y enters a low-power consumption mode when the displayed charge level drops to approximately 0%. In this mode, the Battery stops supporting the onboard electronics and auxiliary 12V battery. Once this low-power consumption mode is active, immediately plug in Model Y to prevent a jump-start and 12V battery replacement.

**Note:** If the vehicle is unresponsive and will not unlock, open, or charge, then the 12V battery may have become discharged. In this situation, contact Tesla.

## Temperature Limits

For better long-term performance, avoid exposing Model Y to ambient temperatures above 140° F (60° C) or below -22° F (-30° C) for more than 24 hours at a time.



## Battery Warnings and Cautions

**Warning:** The Battery has no parts that an owner or a non-Tesla authorized service technician can service. Under no circumstances should you open or tamper with the Battery. Always contact Tesla to arrange for Battery servicing.

**Caution:** If the Battery's charge level falls to 0%, you must plug it in. If you leave it unplugged for an extended period, it may not be possible to charge or use Model Y without jump starting or replacing the 12V battery (see [Instructions for Transporters](#) on page 203 for instructions on how to jump start the battery). Leaving Model Y unplugged for an extended period can



also result in permanent Battery damage. If you are unable to charge Model Y, contact Tesla immediately.

-  **Caution:** The Battery requires no owner maintenance. Do not remove the coolant filler cap and do not add fluid. If the touchscreen warns you that the fluid level is low, contact Tesla immediately.
-  **Caution:** Do not use the Battery as a stationary power source. Doing so voids the warranty.



## Opening the Charge Port

The charge port is located on the left side of Model Y, behind a door that is part of the rear tail light assembly. Before charging, park Model Y to ensure that the charge cable easily reaches the charge port.

With Model Y unlocked (or an authenticated phone is within range) and in Park, press and release the button on the Tesla charge cable to open the charge port door.



You can also open the charge port door using any of these methods:

- On the touchscreen, use the app launcher to open the Charging app, then touch **Open Charge Port**.
- On the car status on the touchscreen, touch the charging icon.
- On the "Cards" area on the touchscreen, touch the charging icon, then press **OPEN CHARGE PORT**.
- Press the bottom of the charge port door when Model Y is unlocked or an authenticated phone is nearby.
- On the key fob accessory (sold separately), hold down the rear trunk button for 1-2 seconds.

**Note:** The following image is provided for demonstration purposes only. Depending on market region, your charge port may be slightly different.



**Note:** The Tesla "T" lights up white when you open the charge port door. If you do not insert a charge cable into the charge port within a few minutes after opening the charge port door, the charge port door closes. If this happens, use the touchscreen to open the charge port door again

**⚠ Caution:** Do not try to force the charge port door open.

## Plugging In

If desired, use the touchscreen to change the charge limit and the charging current (see [Charging Status and Settings](#) on page 165).

To charge at a public charging station, plug the appropriate adapter into the vehicle's charging port, and then connect the station's charging connector to the adapter. The most commonly used adapter(s) for each market region are provided. Depending on the charging equipment you are using, you may need to start and stop charging using a control on the charging equipment.

If you are using the Mobile Connector, plug it into the power outlet before plugging it into Model Y.

Align the connector to the charge port and insert fully. When the connector is properly inserted, charging begins automatically after Model Y:

- Engages a latch that holds the connector in place;
- Shifts into Park (if it was in any other gear);
- Heats or cools the Battery, if needed. If the Battery requires heating or cooling, you may notice a delay before charging begins.



**Note:** Whenever Model Y is plugged in but not actively charging, it draws energy from the wall outlet instead of using energy stored in the Battery. For example, if you are sitting in Model Y and using the touchscreen while parked and plugged in, Model Y draws energy from the wall outlet instead of the Battery.

**⚠ Caution:** The connector end of the charge cable can damage the paint if dropped onto the vehicle.

## During Charging

During charging, the charge port light (the Tesla "T" logo) pulses green, and the touchscreen displays the charging status. The frequency at which the charge port light pulses slows down as the charge level approaches full. When charging is complete, the light stops pulsing and is solid green.

**Note:** If Model Y is locked, the charge port light does not light up.

If the charge port light turns red while charging, a fault is detected. Check the touchscreen for a message describing the fault. A fault can occur due to something as common as a power outage. If a power outage occurs, charging resumes automatically when power is restored.

**Note:** When charging, particularly at high currents, the refrigerant compressor and fan operate as needed to keep the Battery cool. Therefore, it is normal to hear sounds during charging.

**Note:** Air conditioning performance is generally not affected by charging. However, under certain circumstances (for example, you are charging at high currents during a particularly warm day), the air coming from the vents may not be as cool as expected and a message displays on the touchscreen. This is normal behavior and ensures that the Battery stays within an optimum temperature range while charging to support longevity and optimum performance.

**⚠ Warning:** Never spray liquid at a high velocity (for example, if using a pressure washer) towards the charge port while charging. Failure to follow these instructions can result in serious injury or damage to the vehicle, charging equipment, or property.

## Stopping Charging

Stop charging at any time by disconnecting the charge cable or touching **Stop Charging** on the touchscreen.

**Note:** To prevent unauthorized unplugging of the charge cable, the charge cable latch remains locked and Model Y must be unlocked or able to recognize your authenticated phone before you can disconnect the charge cable.

To disconnect the charge cable:

1. Press and hold the button on the connector handle to release the latch. Alternatively, unlock the vehicle by opening a door, using a key card or key fob, or touching **Stop Charging** on the touchscreen. These methods unlock the charge port as well.
2. Pull the connector from the charge port.

**Note:** The charge port automatically closes within approximately 10 seconds of removing the connector from the charge port.

**⚠ Caution:** Tesla strongly recommends leaving Model Y plugged in when not in use. This maintains the Battery at the optimum level of charge.

**⚠ Caution:** Model Y will not shift out of Park if the charge port is unable to determine whether a charging cable is plugged in. Ensure any charging cables are unplugged and follow the instructions on the touchscreen to proceed (see [Park](#) on page 58).

## Manually Releasing Charge Cable

If the usual methods for releasing a charge cable from the charge port (using the charge handle release button, touchscreen, or mobile app) do not work, carefully follow these steps:

1. Ensure that Model Y is not actively charging by displaying the charging screen on the touchscreen. If necessary, touch **Stop Charging**.
2. Open the rear trunk.



3. Pull the charge port's release cable downwards to unlatch the charge cable.



**Note:** The release cable may be recessed within the opening of the trim.

4. Pull the charge cable from the charge port.

**Caution:** The release cable is designed for use only in situations where the charge cable cannot be released from the charge port using the usual methods. Continuous use may result in damage to the release cable or charging equipment.

**Warning:** Do not perform this procedure while your vehicle is charging or if any orange high voltage conductors are exposed. Failure to follow these instructions can result in electric shock and serious injury or damage to the vehicle. If you have any uncertainty as to how to safely perform this procedure, contact your closest Service Center.

**Warning:** Do not attempt to remove the charge cable while simultaneously pulling the release cable. Always pull the release cable before attempting to remove the charge cable from the charge port. Failure to follow these instructions can result in electric shock and serious injury.

- **BLINKING GREEN:** Charging is in progress. As Model Y approaches a full charge, the frequency of the blinking slows.
- **SOLID GREEN:** Charging is complete.
- **SOLID AMBER:** The connector is not fully plugged in. Realign the connector to the charge port and insert fully.
- **BLINKING AMBER:** Model Y is charging at a reduced current (AC charging only).
- **RED:** A fault is detected and charging has stopped. Check the touchscreen for a fault message.

## Charge Port Light

- **WHITE:** The charge port door is open. Model Y is ready to charge and the connector is not inserted, or the charge port latch is unlocked and the connector is ready to be removed.
- **BLUE:** Model Y detects that a connector has been plugged in.
- **BLINKING BLUE:** Model Y is communicating with the connector. Either Model Y is preparing to charge, or a charging session is scheduled to begin at a specified future time.



## Charging Status and Settings

The charging screen displays on the touchscreen whenever the charge port door is open. To display the charging screen at any time:



Touch the charging icon on the "Cards" area on the touchscreen.

The charging screen displays a representative image of the status of the Battery and information about your charging session including:

- Charging rate (in kilowatt hours, miles per hour, or kilometers per hour, depending on your display setting).
- Added energy or estimated increase in driving distance achieved so far in this charging session (in kilowatt hours, miles per hour, or kilometers per hour, depending on your display setting).
- Current supplied/available from the connected power supply.
- Voltage supplied by the charge cable.

**Note:** To change how energy units are displayed, touch **Controls** > **Display** > **Energy Display**.

**Note:** The following illustration is provided for demonstration purposes only and may vary slightly depending on software version and market region.

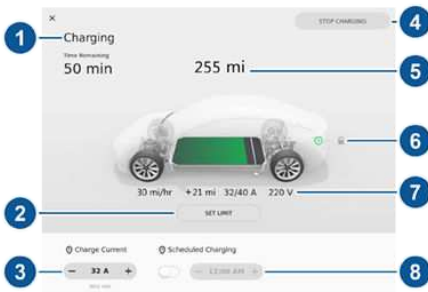

1. Charge status messages (such as Charging, Charging Scheduled) display here. While charging, the estimated time remaining to achieve your set limit is also displayed.

2. Adjust the charge limit by touching **Set Limit**, and drag the arrow to move the charge limit setting. The setting you choose applies to immediate and scheduled charging sessions.
3. The current automatically sets to the maximum current available from the attached charge cable, unless it was previously reduced to a lower level. If needed, touch **-** or **+** to change the current (for example, you may want to reduce the current if you are concerned about overloading a domestic wiring circuit shared by other equipment). It is not possible to set the charging current to a level that exceeds the maximum available from the attached charge cable. When you change the current, Model Y remembers the location. If you charge at the same location, you do not need to change it again.

**Note:** If Model Y is charging and detects unexpected fluctuations in input power, the charging current is automatically reduced by 25%. For example, a 40 amp current is reduced to 30 amps. This automatic current reduction increases robustness and safety in situations when an external problem exists (for example, a home wiring system, receptacle, adapter or cord is unable to meet its rated current capacity). As a precaution, when Model Y automatically reduces current, it saves the reduced current at the charging location. Although you can manually increase it, Tesla recommends charging at the lower current until the underlying problem is resolved and the charging location can provide consistent power.

4. Touch to open the charge port door or to start (or stop) charging.
5. Displays the total estimated driving distance or energy percentage (depending on your display setting) available.
6. Shows if the charge cable is locked in the charge port or not. If Model Y is not charging, you can touch the lock icon to unlock the charge cable from the charge port.

**Note:** In cold ambient temperatures below 41° F (5° C), the charge cable remains unlocked whenever the vehicle is not charging.



7. Charging rate, estimated increase in driving distance (or energy) achieved so far in this charging session, current supplied/available from the connected power supply, and voltage supplied by the charge cable.
8. Set a recurring charging schedule for the location (see [Scheduled Charging and Scheduled Departure](#) on page 167).

**Note:** If charging at a Tesla Supercharger, the charging screen also displays information about your previous or current Supercharger session (see [Supercharger Usage Fees and Idle Fees](#) on page 167).

**Note:** To reduce congestion at high-usage supercharger sites, you may be automatically limited to a maximum charge of 80% when not using Trip Planner (see [Trip Planner](#) on page 136). You can manually increase the limit by tapping “Set Limit” on the touchscreen or mobile app.



## Scheduled Charging and Scheduled Departure

There are two ways in which you can schedule your vehicle's charging:

- **Scheduled Charging:** When you set a scheduled charging time, Model Y displays the set time to begin charging when you are parked at the scheduled location. If, at the scheduled time, Model Y is not plugged in at the location, charging starts as soon as you plug it in, provided you plug it in within six hours of the scheduled time. If plugged in after six hours, charging does not start until the scheduled time on the next day. To override this setting, touch **Start Charging** or **Stop Charging**.
- **Scheduled Departure:** For any location, such as Home, you can simply plug in Model Y and select a time for when you want your vehicle to be ready to drive. Once your specified time is set, Model Y prepares itself by determining the best time to start charging to optimize energy costs, Battery longevity, and ensure charging completes in time for your drive. Your vehicle also preconditions the cabin to a comfortable temperature and warms the Battery. To set up a scheduled departure time, go to **Charging > Scheduled Departure > Schedule** and follow the onscreen instructions to customize your schedule.

Scheduled Charging is best used to determine when your vehicle should start charging; Scheduled Departure is best used to determine when charging should complete for your drive.

**Note:** Your vehicle aims to finish charging before 6am (end of off-peak hours). If given sufficient time to charge, charging may stop at 6am, even if your scheduled departure is later. The vehicle warms the Battery and preconditions the cabin shortly before your scheduled departure time. If the vehicle does not have enough time to complete charging before 6am, it will continue to charge until it reaches the target Battery percentage.

**Note:** If your vehicle is not plugged into a charger, Scheduled departure will not precondition the cabin or battery.

## Supercharger Usage Fees and Idle Fees

When charging using a Tesla supercharger, **SUPERCHARGING** information displays at the bottom of the charging screen. This information includes the location, the time that charging started, and an estimate of how much the session will cost. When you stop supercharging, the estimated cost of that session displays until a new supercharging session begins.

**Note:** Estimated pricing is displayed for your convenience only and may not reflect the actual final price you will be charged for that supercharging session. Final pricing for supercharging sessions can be found in your Tesla Account.

When charging at a Tesla supercharger, you are subject to idle fees. Idle fees are designed to encourage drivers to move their vehicle from the Supercharger when charging is complete. Idle fees are in effect only when half or more of the Superchargers at a site are occupied. The Tesla mobile app notifies you when charging nears completion, and again when charging is complete. Additional notifications are sent if idle fees are incurred. Idle fees are waived if you move your vehicle within five minutes of charging completion.

Log into your Tesla Account to view fees and details about Supercharger sessions, set up a payment method, and make payments. Once a payment method is saved, fees are automatically paid from your account.





## Service Intervals

Your vehicle should generally be serviced on an as-needed basis. However, Tesla recommends the following maintenance items and intervals, as applicable to your vehicle, to ensure continued reliability and efficiency of your Model Y.

- Brake fluid health check every 2 years (replace if necessary)
- A/C desiccant bag replacement every 6 years
- Cabin air filter replacement every 2 years
- Clean and lubricate brake calipers every year or 12,500 miles (20,000 km) if in an area where roads are salted during winter
- Rotate tires every 10,000-12,000 miles (16,000-20,000 km) or if tread depth difference is 2/32 in (1.5 mm) or greater

**Note:** The above intervals are based on normal driving behaviors and scenarios. Additionally, the above list should not be considered comprehensive and does not include consumable parts such as windshield wipers, brake pads, etc.

**Note:** Damages or failures caused by maintenance or repairs performed by non-Tesla certified technicians are not covered by the warranty.

## Daily Checks

- Check the Battery's charge level, displayed on the touchscreen or mobile app.
- Check the condition and pressure of each tire (see [Tire Care and Maintenance](#) on page 170).
- Check that all exterior lights, horn, turn signals, and wipers and washers are working.
- Check for any unexpected indicator lights or vehicle alerts on the touchscreen.
- Check the operation of the brakes, including the parking brake.
- Check the operation of the seat belts (see [Seat Belts](#) on page 32).
- Look for abnormal fluid deposits underneath Model Y that might indicate a leak. It is normal for a small pool of water to form (caused by the air conditioning system's dehumidifying process).

- Look around the exterior of Model Y and immediately remove any corrosive substances (such as bird droppings, tree resin, tar spots, dead insects, industrial fallout, etc.) to prevent damage to the paint (see [Cleaning](#) on page 177).

## Monthly Checks

- Check windshield washer fluid level and top up if necessary (see [Topping Up Windshield Washer Fluid](#) on page 182).
- Check that the air conditioning system is operating correctly (see [Climate Controls](#) on page 127).

**Note:** In addition to cooling the interior, the air conditioning compressor also cools the Battery. Therefore, in hot weather, the air conditioning compressor can turn on even if you turned it off. This is normal because the system's priority is to cool the Battery to ensure it stays within an optimum temperature range to support longevity and optimum performance. Also, even when not in use, you may hear Model Y emit a whining noise or the sound of water circulating. These sounds are normal and occur when the internal cooling systems turn on to support various vehicle functions, such as maintaining the 12V battery and balancing the temperature of the high voltage Battery.

**Warning:** Contact Tesla immediately if you notice any significant or sudden drop in fluid levels or uneven tire wear.

## Fluid Replacement Intervals



Your Battery coolant does not need to be replaced for the life of your vehicle under most circumstances. Brake fluid should be checked every 2 years, replacing if necessary\*.

**Note:** Any damage caused by opening the Battery coolant reservoir is excluded from the warranty.

## High Voltage Safety

Your Model Y has been designed and built with safety as a priority. However, be aware of these precautions to protect yourself from the risk of injury inherent in all high-voltage systems:



- Read and follow all instructions provided on the labels that are attached to Model Y. These labels are there for your safety.
  - The high voltage system has no user-serviceable parts. Do not disassemble, remove or replace high voltage components, cables or connectors. High voltage cables are colored orange for easy identification.
  - If a collision occurs, do not touch any high voltage wiring, connectors, or components connected to the wiring.
  - In the unlikely event that a fire occurs, immediately contact your local fire emergency responders.
-  **Warning:** Always disconnect the charge cable before working underneath Model Y, even if charging is not in progress.
-  **Warning:** Keep your hands and clothing away from cooling fans. Some fans operate even when Model Y is powered off.
-  **Warning:** Some fluids (battery acid, Battery coolant, brake fluid, windshield washer additives, etc.) used in vehicles are poisonous and should not be inhaled, swallowed, or brought into contact with open wounds. For your safety, always read and follow instructions printed on fluid containers.



## Maintaining Tire Pressures

Keep tires inflated to the pressures shown on the Tire and Loading Information label, even if it differs from the pressure printed on the tire itself. The Tire and Loading Information label is located on the center door pillar and is visible when the front door is open.

**Note:** If your Model Y is fitted with Tesla accessory wheels or tires, some information may be different from the labels on the vehicle.



The Tire Pressure indicator light on the touchscreen alerts you if one or more tires is under-inflated.

After inflating the tire to the recommended pressure, you must drive over 15 mph (25 km/h) for a short amount of time to activate the Tire Pressure Monitoring System (TPMS), which turns off the Tire Pressure indicator light.

If the indicator light flashes for one minute whenever you power on Model Y, a fault with the TPMS is detected (see [TPMS Malfunction](#) on page 175).

**Note:** Display tire pressures in the "Cards" area, located toward the bottom on the left side of the touchscreen, as described in [Touchscreen Overview](#) on page 4. You can also choose whether you want to display tire pressures using BAR or PSI by touching **Controls > Display > Tire Pressure**.

**Warning:** Under-inflation is the most common cause of tire failures and can cause a tire to overheat, resulting in severe tire cracking, tread separation, or blowout, which causes unexpected loss of vehicle control and increased risk of injury. Under-inflation also reduces the vehicle's range and tire tread life.

**Warning:** Check tire pressures using an accurate pressure gauge when tires are cold. It takes only about one mile (1.6 km) of driving to warm up the tires sufficiently to affect tire pressures. Parking the vehicle in direct sunlight or in hot weather can also affect tire pressures. If you must check warm tires, expect increased pressures. Do not let air out of warm tires in an attempt to match recommended cold tire pressures. A hot tire at or below the recommended cold tire inflation pressure is dangerously under-inflated.

**Warning:** Do not use any tire sealant other than the type provided in a Tesla tire repair kit. Other types can cause tire pressure sensors to malfunction. If your Model Y did not include a tire repair kit, you can purchase one from Tesla.



### Checking and Adjusting Tire Pressures

Follow these steps when tires are cold and Model Y has been stationary for over three hours:

1. Refer to the Tire and Loading Information label located on the driver's center door pillar for the target tire pressure.
2. Remove the valve cap.
3. Firmly press an accurate tire pressure gauge onto the valve to measure pressure.
4. If required, add or remove air to reach the recommended pressure.

**Note:** You can release air by pressing the metal stem in the center of the valve.

5. Re-check pressure using the accurate tire gauge.
6. Repeat steps 3 and 4 as necessary until the tire pressure is correct.
7. Reinstall the valve cap to prevent dirt from entering. Periodically check the valve for damage and leaks.

### Inspecting and Maintaining Tires

Regularly inspect the tread and side walls for any sign of distortion (bulges), foreign objects, cuts or wear.

**⚠ Warning:** Do not drive Model Y if a tire is damaged, excessively worn, or inflated to an incorrect pressure. Check tires regularly for wear, and ensure there are no cuts, bulges or exposure of the ply/cord structure.

#### Tire Wear

Adequate tread depth is important for proper tire performance. Tires with a tread depth less than 4/32" (3 mm) are more likely to hydroplane in wet conditions and should not be used. Tires with a tread depth less than 5/32" (4 mm) do not perform well in snow and slush and should not be used when driving in winter conditions.

Model Y is originally fitted with tires that have wear indicators molded into the tread pattern. When the tread has been worn down to 4/32" (3 mm), the indicators start to appear at the surface of the tread pattern, producing the effect of a continuous band of rubber across the width of the tire. For optimal performance and safety, Tesla recommends replacing tires before the wear indicators are visible.

#### Tire Rotation, Balance, and Wheel Alignment

Tesla recommends rotating the tires every 10,000-12,000 miles (16,000-20,000 km) or if tread depth difference is 2/32 in (1.5 mm) or greater.

Unbalanced wheels (sometimes noticeable as vibration through the steering wheel) affect vehicle handling and tire life. Even with regular use, wheels can get out of balance. Therefore, they should be balanced as required.

If tire wear is uneven (on one side of the tire only) or becomes abnormally excessive, check the alignment of wheels.

**Note:** When replacing only two tires, install the new tires on the rear if your vehicle's front and rear tires are the same size.



## Punctured Tires

A puncture eventually causes the tire to lose pressure, which is why it is important to check tire pressures frequently. Permanently repair or replace punctured or damaged tires as soon as possible.

Your tubeless tires may not leak when penetrated, provided the object remains in the tire. If, however, you feel a sudden vibration or ride disturbance while driving, or you suspect a tire is damaged, immediately reduce your speed. Drive slowly, while avoiding heavy braking or sharp steering and, when safe to do so, stop the vehicle. Arrange to have Model Y transported to a Tesla Service Center, or to a nearby tire repair center.

**Note:** In some cases, you can temporarily repair small tire punctures (under 1/4" (6 mm)) using an optional tire repair kit available from Tesla. This allows you to slowly drive Model Y to Tesla or to a nearby tire repair facility.

**Warning:** Do not drive with a punctured tire that has not been repaired, even if the puncture has not caused the tire to deflate. A punctured tire can deflate suddenly at any time.

## Flat Spots

If Model Y is stationary for a long period, tires can form flat spots. When Model Y is driven, these flat spots cause a vibration which gradually disappears as the tires warm up and regain their original shape.

To minimize flat spots during storage, inflate tires to the maximum pressure indicated on the tire wall. Then, before driving, release air to adjust tire pressure to the recommended levels.

## Improving Tire Mileage

To improve the mileage you get from your tires, maintain tires at the recommended tire pressures, observe speed limits and advisory speeds, and avoid:

- Pulling away quickly, or hard acceleration.
- Fast turns and heavy braking.
- Potholes and objects in the road.
- Hitting curbs when parking.
- Contaminating tires with fluids that can cause damage.

## Replacing Tires and Wheels

Tires degrade over time due to the effects of ultraviolet light, extreme temperatures, high loads, and environmental conditions. It is recommended that tires are replaced every six years, or sooner if required, even if tread depth is above the minimum.

Wheel and tires are matched to suit the handling characteristics of the vehicle. Replacement tires must comply with the original specification. If tires other than those specified are used, ensure that the load and speed ratings marked on the tire (see [Understanding Tire Markings](#) on page 196) equal or exceed those of the original specification.

Ideally, you should replace all four tires at the same time. If this is not possible, replace the tires in pairs, placing the new tires on the rear. Always balance the wheel and tire after replacing a tire.

If you replace a wheel, the TPMS (Tire Pressure Monitoring System) sensors need to be reset to ensure they provide accurate warnings when tires are under-inflated (see [Automatic Reset of TPMS Sensors](#) on page 175).

For the specification of the original wheels and tires installed on Model Y, see [Wheels and Tires](#) on page 194.

**Note:** Installing winter tires with aggressive compound and tread design may result in temporarily-reduced regenerative braking power. However, your vehicle is designed to continuously recalibrate itself, and after changing tires it will increasingly restore regenerative braking power after some moderate-torque straight-line accelerations. For most drivers this occurs after a short period of normal driving, but drivers who normally accelerate lightly may need to use slightly harder accelerations while the recalibration is in progress.

**Warning:** For your safety, use only tires and wheels that match the original specification. Tires that do not match the original specification can affect the operation of the TPMS.

**Warning:** Never exceed the speed rating of your vehicle's tires. The speed rating is shown on the sidewall of your tires (see [Understanding Tire Markings](#) on page 196).



### Asymmetric Tires

Model Y tires are asymmetric and must be mounted on the wheel with the correct sidewall facing outward. The sidewall of the tire is marked with the word OUTSIDE. When new tires are installed, make sure that the tires are correctly mounted on the wheels.



**⚠ Warning:** Road holding is seriously impaired if the tires are incorrectly installed on the wheels.

### Removing and Installing Aero Covers

If your Model Y is equipped with aero covers, you must remove them to access the lug nuts.

To remove an aero cover:

1. Grasp the aero cover firmly with both hands.
2. Pull the aero cover toward you to release the retaining clips.



To install an aero cover:

1. Align the aero cover into position so that the notch at the base of the Tesla "T" is aligned with the tire's valve stem.



2. Push firmly around the perimeter of the aero cover until it fully snaps into place.

For Gemini wheels, press on the perimeter of the cover until it aligns with the wheel surface. Press on the Tesla "T" in the center until the cap snaps into place. See [Parts and Accessories](#) on page 184 for more information.

**⚠ Caution:** Make sure the aero cover is fully secure before driving to prevent it from falling off.



## Removing and Installing Lug Nut Covers

If your Model Y is equipped with lug nut covers, you must remove them to access the lug nuts.

To remove a lug nut cover:

1. Place the curved part of the lug nut cover tool (located in the glovebox for some vehicles, or you can use a small allen wrench) into the lowered perimeter around the middle of the lug nut cover.

**Note:** The lug nut cover tool can also be purchased at an auto parts store or through online retailers.



2. Twist the lug nut cover tool so that the end of the curved part is facing away from the Tesla "T".
3. Firmly pull the lug nut tool away from the wheel until the lug nut cover is released.



To install the lug nut cover:

1. Align the lug nut cover into position.
2. Push firmly on the lug nut cover until it fully snaps into place.

**⚠ Caution:** Make sure the lug nut cover is fully secure before driving to prevent it from falling off.

## Tire Pressure Monitoring

Each tire should be checked monthly when cold and inflated to the recommended pressures that are printed on the Tire and Loading Information label located on the driver's door pillar (see [Maintaining Tire Pressures](#) on page 170). If your vehicle has tires of a different size than the size indicated on the vehicle placard or tire inflation pressure label, determine the proper tire inflation pressure for those tires.

As an added safety feature, your vehicle has been equipped with a TPMS that displays a tire pressure telltale (Tire Pressure Warning) on the touchscreen when one or more of your tires is significantly under-inflated. Accordingly, when the Tire Pressure indicator light displays on the touchscreen to alert you about tire pressure, stop and check your tires as soon as possible, and inflate them to the proper pressure (see [Maintaining Tire Pressures](#) on page 170). Driving on a significantly under-inflated tire causes the tire to overheat and can lead to tire failure. Under-inflation also reduces range efficiency and tire tread life, and may affect the vehicle's handling and stopping ability.



If Model Y detects a fault with the TPMS, this indicator flashes for one minute whenever you power on Model Y.

**Note:** Installing accessories that are not approved by Tesla can interfere with the TPMS.

**⚠ Caution:** Avoid placing powered USB devices near the card reader on the center console (see [Keys](#) on page 9) as powered USB devices may interfere with the tire pressure monitoring system.

**⚠ Warning:** The TPMS is not a substitute for proper tire maintenance, including manually checking tire pressures and regularly inspecting the condition of tires. It is the driver's responsibility to maintain correct tire pressure, even if under- or over-inflation has not reached the level for the TPMS to trigger the Tire Pressure Warning on the touchscreen.



### Automatic Reset of TPMS Sensors

After replacing one or more wheels (but not after replacing a tire), the TPMS sensors are relearned to ensure tire pressure warnings are accurate. TPMS sensors reset automatically within 10 minutes of driving over 15 mph (25 km/h).

**Warning:** If your Model Y is equipped with aftermarket tires that differ in size from those printed on the Tire and Loading Information Label (see [Vehicle Loading](#) on page 186), it is the driver's responsibility to determine the correct tire pressure. Do not drive on public roads when tires are not inflated to the correct pressure.

**Warning:** Do not depend on TPMS sensors to accurately determine pressures and trigger alerts. It is the driver's responsibility to maintain correct tire pressures (see [Maintaining Tire Pressures](#) on page 170). Over or under-inflated tires can result in loss of control or tire damage, which can lead to serious injury.

### Replacing a Tire Sensor

If the Tire Pressure warning indicator displays frequently, contact Tesla to determine if a tire sensor needs to be replaced. If a non-Tesla Service Center repairs or replaces a tire, the tire sensor may not work until Tesla performs the setup procedure.

### TPMS Malfunction

Model Y has also been equipped with a TPMS malfunction indicator to indicate when the system is not operating properly.



The TPMS malfunction indicator is combined with the tire pressure indicator light. When the system detects a malfunction, the indicator flashes for approximately one minute, then remains continuously lit. This sequence continues upon subsequent vehicle start-ups as long as the malfunction exists. When the TPMS malfunction indicator is on, the system might not be able to detect or signal under-inflated tires as intended.

TPMS malfunctions can occur for a variety of reasons, including installing replacement or alternate tires or wheels that prevent the TPMS from functioning properly. Always check the TPMS malfunction indicator light after replacing one or more tires or wheels on your vehicle to ensure that the replacement tires or wheels allow the TPMS to continue to function properly.

**Note:** If a tire has been replaced or repaired using a different tire sealant than the one available from Tesla, and a low tire pressure is detected, it is possible that the tire sensor has been damaged. Contact Tesla to have the fault repaired as soon as possible.





## Seasonal Tire Types

### Summer Tires

Your vehicle may be originally equipped with high performance summer tires or all season tires. Tesla recommends using winter tires if driving in cold temperatures or on roads where snow or ice may be present. Contact Tesla for winter tire recommendations.

**Warning:** In cold temperatures or on snow or ice, summer tires do not provide adequate traction. Selecting and installing the appropriate tires for winter conditions is important to ensure the safety and optimum performance of your Model Y.

### All-Season Tires

Your Model Y may be originally equipped with all-season tires. These tires are designed to provide adequate traction in most conditions year-round, but may not provide the same level of traction as winter tires in snowy or icy conditions. All-season tires can be identified by “ALL SEASON” and/or “M+S” (mud and snow) on the tire sidewall.

### Winter Tires

Use winter tires to increase traction in snowy or icy conditions. When installing winter tires, always install a complete set of four tires at the same time. Winter tires must be the same diameter, brand, construction and tread pattern on all four wheels. Contact Tesla for winter tire recommendations.



Winter tires can be identified by a mountain/snowflake symbol on the tire's sidewall.

When driving with winter tires, you may experience more road noise, shorter tread life, and less traction on dry roads.

**Note:** Installing winter tires with aggressive compound and tread design may result in temporarily-reduced regenerative braking power. However, your vehicle is designed to recalibrate itself to restore regenerative braking power after a short period of normal driving.

## Driving in Low Temperatures

Tire performance is reduced in low ambient temperatures, resulting in reduced grip and an increased susceptibility to damage from impacts. Performance tires can temporarily harden when cold, causing you to hear rotational noise for the first few miles (kilometers) until the tires warm up.

## Using Tire Chains

Refer to the Owner's Manual on your vehicle's touchscreen for information on recommended tire chains.

When installing tire chains, follow the instructions and warnings provided by the tire chain manufacturer. Mount them evenly and as tight as possible.

When using tire chains:

- Inspect the tire chains for loose fittings and damaged links before each use.
- Avoid heavily loading Model Y (heavy loads can reduce the clearance between the tires and the body).
- Do not drive the vehicle without the chains properly installed.
- Drive slowly. Do not exceed 30 mph (48 km/h).
- Remove the tire chains as soon as conditions allow.

**Note:** Tire chains are prohibited in some jurisdictions. Check local laws before installing tire chains.

**Caution:** Using non-recommended tire chains, or using tire chains on other sized tires can damage the suspension, body, wheels, and/or brake lines. Damage caused by using non-recommended tire chains, or incorrectly installing tire chains, is not covered by the warranty.

**Caution:** Do not use tire chains on the front tires.

**Caution:** Never deflate your tires to put on tire chains. When re-inflated, the chains might fit too tightly and cause tire damage.

**Caution:** Ensure that the tire chains cannot touch suspension components or brake lines. If you hear the chains making unusual noises that would indicate contact with Model Y, stop and investigate immediately.



## Cleaning the Exterior

To prevent damage to the paint, immediately remove corrosive substances (bird droppings, tree resin, dead insects, tar spots, road salt, industrial fallout, etc.). Do not wait until Model Y is due for a complete wash. If necessary, use denatured alcohol to remove tar spots and stubborn grease stains, then immediately wash the area with water and a mild, non-detergent soap to remove the alcohol.

Keep the exterior cameras free of dirt, condensation, or obstructions. Occasionally remove any buildup of dirt by wiping the components with a soft cloth dampened with warm water. These substances can cause autopilot and safety features to stop working (see [Cleaning Cameras and Sensors](#) on page 84).

Follow these steps when washing the exterior of Model Y:

### 1. Rinse Thoroughly

Before washing, flush grime and grit from the vehicle using a hose. Flush away accumulations of mud in areas where debris easily collects (such as wheel wells and panel seams). If salt has been used on the highways (such as during winter months), thoroughly rinse all traces of road salt from the underside of the vehicle, wheel wells, and brakes.

### 2. Hand Wash

Hand wash Model Y using a clean soft cloth and cold or lukewarm water containing a mild, high-quality car shampoo.

### 3. Rinse with Clean Water













After washing, rinse with clean water to prevent soap from drying on the surfaces.

### 4. Dry Thoroughly and Clean Exterior Glass

After washing and rinsing, dry thoroughly with a chamois. If necessary, dry the brakes by going on a short drive and applying the brakes multiple times.

Clean windows and mirrors using an automotive glass cleaner. Do not scrape, or use any abrasive cleaning fluid on glass or mirrored surfaces.

## Cautions for Exterior Cleaning

-  **Caution:** Do not use windshield treatment fluids. Doing so can interfere with wiper friction and cause a chattering sound.
-  **Caution:** Do not use hot water or detergents.
-  **Caution:** Do not wash in direct sunlight.
-  **Caution:** If using a pressure washer, maintain a distance of at least 12" (30 cm) between the nozzle and the surface of Model Y. Keep the nozzle moving and do not concentrate the water jet on any one area.
-  **Caution:** Do not aim water hoses directly at window, door, or hood seals.
-  **Caution:** Do not aim water hoses at electronic modules or exposed cabling.
-  **Caution:** To avoid corrosive damage that may not be covered by the warranty, rinse away any road salt from the underside of the vehicle, wheel wells, and brakes. After cleaning the vehicle, dry the brakes by going on a short drive and applying the brakes multiple times.
-  **Caution:** Avoid using tight-napped or rough cloths, such as washing mitts.
-  **Caution:** If washing in an automatic car wash, use touchless car washes only. These car washes have no parts (brushes, etc.) that touch the surfaces of Model Y. Using any other type of car wash could cause damage that is not covered by the warranty.
-  **Caution:** Ensure the wipers are off before washing Model Y to avoid the risk of damaging the wipers.
-  **Caution:** Do not use chemical based wheel cleaners. These can damage the finish on the wheels.
-  **Caution:** Avoid using a high pressure power washer on the camera(s) or parking sensors (if equipped) and do not clean a sensor or camera lens with a sharp or abrasive object that can scratch or damage its surface.
-  **Warning:** Never spray liquid at a high velocity (for example, if using a pressure washer) towards the charge port while Model Y is charging. Failure to follow these instructions can result in serious injury or damage to the vehicle, charging equipment, or property.



## Cleaning the Interior

Frequently inspect and clean the interior to maintain its appearance and to prevent premature wear. If possible, immediately wipe up spills and remove marks. For general cleaning, wipe interior surfaces using a soft cloth (such as microfiber) dampened with a mixture of warm water and mild non-detergent cleaner (test all cleaners on a concealed area before use). To avoid streaks, dry immediately with a soft lint-free cloth.

### Interior Glass

Do not scrape, or use any abrasive cleaning fluid on glass or mirrored surfaces. This can damage the reflective surface of the mirror and the heating elements in the rear window.

### Airbags

Do not allow any substance to enter an airbag cover. This could affect correct operation.

### Dashboard and Plastic Surfaces

Do not polish the upper surfaces of the dashboard. Polished surfaces are reflective and could interfere with your driving view.

### Polyurethane Seats

Wipe spills as soon as possible using a soft cloth moistened with warm water and non-detergent soap. Wipe gently in a circular motion. After cleaning, allow the seats to air dry.

Be careful with dyes, such as from clothing or denim, that come into contact with the seats. Dyes can diffuse into the seat material over time and cause staining.

**⚠ Caution:** Aftermarket, non-Tesla seat covers may inhibit the sensitivity of seat sensors and may cause staining or damage.

### Cloth Seats

Wipe spills as soon as possible using a soft cloth moistened with warm water and non-detergent soap. Wipe gently in a circular motion. Then wipe dry using a soft, lint-free cloth. Vacuum the seats as needed to remove any loose dirt.

### Carpets

Avoid over-wetting carpets. For heavily soiled areas, use a diluted upholstery cleaner.

### Seat Belts

Extend the belts to wipe. Do not use any type of detergent or chemical cleaning agent. Allow the belts to dry naturally while extended, preferably away from direct sunlight.

### Touchscreen

Clean the touchscreen using a soft lint-free cloth specifically designed to clean monitors and displays. Do not use cleaners (such as a glass cleaner) and do not use a wet wipe or a dry statically-charged cloth (such as a recently washed microfiber). To wipe the touchscreen without activating buttons and changing settings, you can enable Screen Clean Mode. Touch **Controls > Display > Screen Clean Mode**. The display darkens to make it easy to see dust and smudges. To exit Screen Clean Mode, press and hold **HOLD TO EXIT**.

### Chrome and Metal Surfaces

Polish, abrasive cleaners or hard cloths can damage the finish on chrome and metal surfaces.

### Cautions for Interior Cleaning

**⚠ Caution:** Using solvents (including alcohol), bleach, citrus, naphtha, or silicone-based products or additives on interior components can cause damage.

**⚠ Caution:** Statically-charged materials can cause damage to the touchscreen.

**⚠ Warning:** If you notice any damage on an airbag or seat belt, contact Tesla immediately.

**⚠ Warning:** Do not allow any water, cleaners, or fabric to enter a seat belt mechanism.

**⚠ Warning:** Exposure to chemical cleaners can be hazardous and can irritate eyes and skin. Read and observe the instructions provided by the manufacturer of the chemical cleaner.

## Polishing, Touch Up, and Body Repair

To preserve the cosmetic appearance of the body, you can occasionally treat the paint surfaces with an approved polish containing:



- Very mild abrasive to remove surface contamination without removing or damaging the paint.
- Filling compounds that fill scratches and reduce their visibility.
- Wax to provide a protective coating between the paint and environmental elements.

Regularly inspect the exterior paint for damage. Treat minor chips and scratches using a paint touch-up pen (available for purchase from Tesla). Use the touch-up pen after washing but before polishing or waxing.

Repair rock chips, fractures or scratches. Refer to <https://www.tesla.com/support/body-shop-support> for more information on repair locations and available services.

**⚠ Caution:** Do not use cutting pastes, color restoration compounds, or polishes containing harsh abrasives. These can scour the surface and permanently damage the paint.

**⚠ Caution:** Do not use chrome polish or other abrasive cleaners.

## Using a Car Cover

To preserve the cosmetic appearance of the body when Model Y is not being used, use a genuine Tesla car cover. Car covers can be purchased from Tesla. See [Parts and Accessories](#) on page 184.

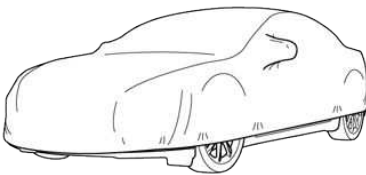

**⚠ Caution:** Use only a Tesla-approved car cover when Model Y is plugged in. Using a non-Tesla car cover can prevent the Battery from being adequately cooled during charging.

## Floor Mats

To extend the life of your carpet and make them easier to clean, use genuine Tesla floor mats (see [Parts and Accessories](#) on page 184). Maintain floor mats by regularly cleaning them and checking that they are properly attached. Replace floor mats if they become excessively worn.

**⚠ Warning:** To avoid potential interference with a foot pedal, ensure that the driver's floor mat is securely fastened, and never place an additional floor mat on top of it. Floor mats should always rest on top of the vehicle carpeting surface and not on another floor mat or other covering.



## Checking and Cleaning Wiper Blades

Periodically clean the edge of the wiper blades and check the rubber for cracks, splits, and roughness. If damaged, replace the blade immediately to prevent damage to the glass and improve visibility.

Contaminants on the windshield, or on the wiper blades, can reduce the effectiveness of the wipers. Contaminants include ice, wax spray from car washes, washer fluid with bug and/or water repellent, bird droppings, tree sap, and other organic substances.

Follow these guidelines for cleaning:

- Clean the windshield and wiper blades using washer fluid, isopropyl (rubbing) alcohol, or non-abrasive glass cleaner approved for use on automotive glass and rubber. Inappropriate products can cause damage or smears, and create glare on the windshield.
- Lift the wiper arm a short distance away from the windshield, just far enough to access the wiper blade. Do not lift a wiper arm beyond its intended position.

If the wipers remain ineffective after cleaning, replace the wiper blades.

## Replacing Wiper Blades

For optimum performance, replace the wiper blades at least once a year.

**Note:** Only install replacement blades that are identical to the original blades. Using inappropriate blades can damage the wiper system and windshield.

To replace the wiper blades:

1. Shift into Park and turn off the wipers.
2. Touch **Controls** > **Service** > **Wiper Service Mode** > **ON** to move the wipers to the service position.
3. Lift the wiper arm a short distance away from the windshield, just far enough to access the wiper blade.
  - ⚠ **Caution:** Wiper blades do not lock into a lifted position. Do not lift a wiper arm beyond its intended position.
4. Place a towel between the wiper arm and windshield to avoid scratching or cracking the windshield.

5. Hold the wiper arm and press the locking tab while sliding the blade down the arm.



6. Align the new wiper blade on the wiper arm and slide it toward the end of the wiper arm until it locks into place.
7. Turn Wiper Service Mode off to return the wipers to their normal position.

## Cleaning Washer Jets

If a windshield washer becomes blocked, use a thin strand of wire to clear any blockages from the nozzles.

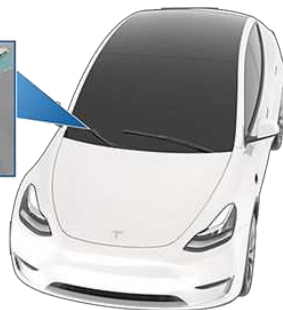
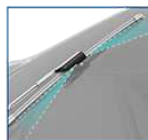

- ⚠ **Warning:** Do not operate the washers while cleaning Model Y. Windshield washer fluid can irritate eyes and skin. Read and observe the washer fluid manufacturer's instructions.



## Removing the Maintenance Panel

To check fluid levels, remove the maintenance panel:

1. Open the hood.
2. Pull the maintenance panel upward to release the clips that hold it in place.



3. If checking the Battery coolant, remove the cabin intake trim panel by pulling it upwards to release the clips that hold it in place.

**⚠ Caution:** The maintenance panel protects the front trunk from water. When re-attaching, make sure it is fully seated.

## Checking Battery Coolant

Your Battery coolant should not need to be replaced for the life of your vehicle under most circumstances. However, if the quantity of fluid in the cooling system drops below the recommended level, the touchscreen displays a warning message. Stop driving Model Y as soon as safety permits and contact Tesla.

### Fluid Level Check

DO NOT REMOVE THE FILLER CAP AND DO NOT ADD FLUID. Doing so can result in damage not covered by the warranty.

### Do Not Top Up Battery Coolant

**⚠ Warning:** Battery coolant can be hazardous and can irritate eyes and skin. Under no circumstances should you remove the filler cap and/or add coolant. If the touchscreen warns you that the fluid level is low, contact Tesla immediately.

To maximize the performance and life of the Battery, the cooling system uses a specific mixture of G-48 ethylene-glycol coolant (HOAT). Contact Tesla for more specific information about the coolant.



## Checking Brake Fluid

**Warning:** Contact Tesla immediately if you notice increased movement of the brake pedal or a significant loss of brake fluid. Driving under these conditions can result in extended stopping distances or complete brake failure.



A red brake indicator on the touchscreen alerts you if the quantity of fluid in the brake reservoir drops below the recommended level. If it displays while driving, stop as soon as safety permits by gently applying the brakes. Do not continue driving. Contact Tesla immediately.

## Topping Up the Brake Fluid

Do not top up your brake fluid. The following instructions are provided for information purposes and future reference only:

1. Clean the filler cap before removing it to prevent dirt from entering the reservoir.
2. Unscrew the cap and remove it.
3. Top up the reservoir to the MAX mark using the appropriate brake fluid.
4. Replace the filler cap, ensuring it is fully secured.

**Warning:** Only use new fluid from a sealed air-tight container. Never use previously used fluid or fluid from a previously opened container—fluid absorbs moisture which decreases braking performance.

**Warning:** Brake fluid is highly toxic. Keep containers sealed and out of the reach of children. In the event of accidental consumption, seek medical attention immediately.

**Caution:** Brake fluid damages painted surfaces. Immediately soak up any spills with an absorbent cloth and wash the area with a mixture of car shampoo and water.

## Topping Up Windshield Washer Fluid

The only reservoir into which you can add fluid is the windshield washer fluid reservoir, which is located behind the front trunk. When the level is low, a message displays on the touchscreen.

To top up the washer fluid:

1. Open the hood.
2. Clean around the filler cap before opening it to prevent dirt from entering the reservoir.
3. Open the filler cap.
4. While avoiding spilling, fill the reservoir until the fluid level is visible just below the filler neck. The reservoir has a capacity of 4.5 liters.

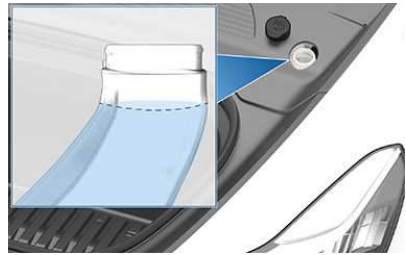

5. Wipe up any spills immediately and wash the affected area with water.
6. Replace the filler cap.

**Note:** Some national or local regulations restrict the use of Volatile Organic Compounds (VOCs). VOCs are commonly used as antifreeze in washer fluid. Use a washer fluid with limited VOC content only if it provides adequate freeze resistance for all climates in which you drive Model Y.

**Caution:** Do not add formulated washer fluids that contain water repellent or bug wash. These fluids can cause streaking, smearing, and squeaking or other noises.

**Warning:** In temperatures below 40° F (4° C), use a washer fluid with antifreeze. In cold weather, using a washer fluid without antifreeze can impair visibility through the windshield.

**Warning:** Windshield washer fluid can irritate eyes and skin. Read and observe the instructions provided by the washer fluid manufacturer.



## Jacking Procedure

Follow the steps below to lift Model Y. Ensure that any non-Tesla repair facility is aware of these lifting points.

1. Position Model Y centrally between the lift posts.
2. Position the lift arm pads under the designated body lift points at the locations shown.

**⚠ Warning:** DO NOT position the lift arm pads under the Battery or side rails, as shown in red.

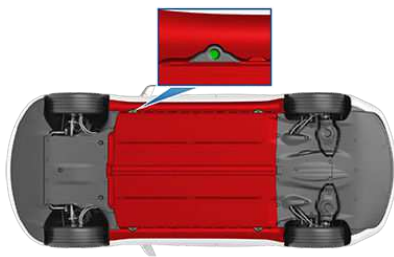

3. Adjust the height and position of the lift arm pads to ensure that they are correctly located.
4. With assistance, raise the lift to the desired height, ensuring the lift arm pads remain in their correct positions.
5. Engage any lift safety locks. Follow the lift manufacturer's instructions.

**⚠ Warning:** Never raise Model Y when the charge cable is connected, even if charging is not in progress.

**⚠ Warning:** Do not work on an incorrectly supported vehicle. Doing so can cause serious damage, bodily injury, or death.

**⚠ Caution:** DO NOT lift from under the Battery or side rails. Place the lift arm pads under the designated body lift points only. The locations shown are the only approved lifting points for Model Y. Lifting at any other points can cause damage. Damage caused by incorrectly lifting Model Y is not covered by the warranty.





## Parts, Accessories, and Modifications

Use only genuine Tesla parts and accessories. Tesla performs rigorous testing on parts to ensure their suitability, safety, and reliability. Purchase these parts from Tesla, where they are professionally installed and where you can receive expert advice about modifications to Model Y. Accessories are available for purchase from Tesla stores or online at [www.tesla.com](http://www.tesla.com).

**Note:** Some accessories may not be available in your market region.

Tesla is unable to assess parts manufactured by other distributors and therefore accepts no responsibility if you use non-Tesla parts on Model Y.

- Warning:** Installing non-approved parts and accessories, or performing non-approved modifications, can affect the performance of Model Y and the safety of its occupants. Any damage caused by using or installing non-approved parts, or by performing non-approved modifications, is not covered by the warranty.
- Warning:** Tesla does not accept liability for death, personal injury or damage that occurs if you use or install non-approved accessories or make non-approved modifications.

## Body Repairs

If your Model Y is in a collision, contact Tesla or a Tesla-approved Body Shop to ensure that it is repaired with genuine Tesla parts. Tesla has selected and approved body shops that meet strict requirements for training, equipment, quality, and customer satisfaction.

Some repair shops and insurance companies might suggest using non-original equipment or salvaged parts to save money. However, these parts do not meet Tesla's high standards for quality, fit and corrosion resistance. In addition, non-original equipment and salvaged parts (and any damage or failures they might cause) are not covered by the warranty.

## Using RFID Transponders

When attaching an RFID transponder (used by many automated toll systems) inside Model Y, place the transponder on the right side of the rear view mirror as shown. This ensures best results and minimizes any obstruction to your driving view.

**Note:** You can also attach a weather-proof transponder to the front license plate.





## Vehicle Identification Number

You can find the VIN at the following locations:

- Touch the Tesla "T" at the top center of the touchscreen. The popup window displays the VIN.
- Stamped on a plate located at the top of the dashboard. Can be seen by looking through the windshield.

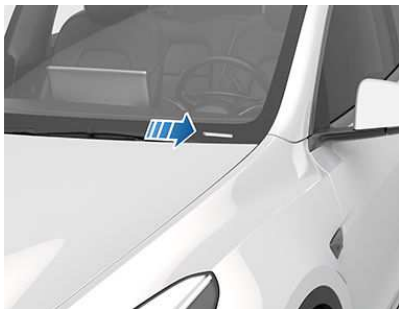

- Printed on the Vehicle Certification label, located on the door pillar. Can be seen when the driver's door is open.



## Emission Control Label

The emission control label is located on the opening face of the liftgate.





## Load Capacity Labeling

It is important to understand how much weight your Model Y can safely carry. This weight is called the vehicle capacity weight and includes the weight of all occupants, cargo and any additional equipment added to your Model Y since it was manufactured.

Two labels attached to Model Y indicate how much weight Model Y can safely carry.

Both labels are visible on the door pillar when the front door is open.

**Note:** If your Model Y is fitted with Tesla accessory wheels or tires, your Model Y may include an additional label indicating that load capacity may differ from what is stated on the label. If this is the case, instead of referring to the label, refer to the Owner's Manual.

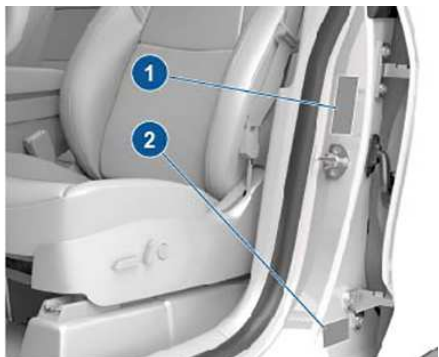

1. Tire and Loading Information Label
2. Vehicle Certification Label

**Warning:** Overloading Model Y has an adverse effect on braking and handling, which can compromise your safety or cause damage.

**Caution:** Never load more than 55 lbs (25 kg) in the front trunk. Doing so can cause damage.

**Caution:** Never load more than 130 lbs (60 kg) on the rear load floor (above the lower trunk compartment) or more than 285 lbs (130 kg) in the lower trunk compartment. Doing so can cause damage.

**Caution:** Never store large amounts of liquid in Model Y. A significant spill can cause electrical components to malfunction.

## Tire and Loading Information Label

The Tire and Loading Information label provides:

- The maximum number of occupant seating positions.
- The maximum vehicle capacity weight.
- The size of the original tires.
- The cold inflation pressures for the original front and rear tires. These pressures are recommended to optimize ride and handling characteristics.



Never change this label, even if you use different tires in the future.

**Note:** If Model Y is loaded to its full capacity, double check all tires to ensure they are inflated to their recommended pressure levels.

## Vehicle Certification Label

The Vehicle Certification label provides:

- GVWR - Gross Vehicle Weight Rating. The maximum allowable total mass of Model Y. This is calculated as the weight of Model Y, all passengers, fluids, and cargo.
- GAWR FRT and GAWR RR - Gross Axle Weight Rating for the front and rear axles. The GAWR is the maximum distributed weight that each axle can support.

United States:

MFD BY TESLA, INC.			
GVWR	WITH TIRES		
GAWR FRT	WITH TIRES	RIM	COLD TIRE PRESSURE
GAWR RR	WITH TIRES	RIM	COLD TIRE PRESSURE
THIS VEHICLE CONFORMS TO ALL APPLICABLE U.S. FEDERAL MOTOR VEHICLE SAFETY STANDARDS IN EFFECT ON THE DATE OF MANUFACTURE SHOWN ABOVE.			

Canada:



<b>EC</b>	<b>MFD BY TESLA, INC./FABRIQUÉ PAR TESLA, INC.</b>		
	<small>GVWR/PNBV</small>	<small>WITH TIRES/AVEC PNEUS</small>	
<small>GAWR FR1/PNBE AVT</small>	<small>WITH TIRES/AVEC PNEUS</small>	<small>RIM/JANTE</small>	<small>COLD TIRE PRESSURE/PRESSION DES PNEUS À FROID</small>
<small>GAWR FR1/PNBE AVT</small>	<small>WITH TIRES/AVEC PNEUS</small>	<small>RIM/JANTE</small>	<small>COLD TIRE PRESSURE/PRESSION DES PNEUS À FROID</small>
<small>THIS VEHICLE CONFORMS TO ALL APPLICABLE STANDARDS PRESCRIBED UNDER THE CANADIAN MOTOR VEHICLE SAFETY REGULATIONS IN EFFECT ON THE DATE OF MANUFACTURE. CE VÉHICULE EST CONFORME À TOUTES LES NORMES QUI LUI SONT APPLICABLES EN VERTU DU RÈGLEMENT SUR LA SÉCURITÉ DES VÉHICULES AUTOMOBILES DU CANADA EN VIGUEUR À LA DATE DE SA FABRICATION.</small>			

**⚠ Caution:** To prevent damage, never load Model Y so that it is heavier than GVWR or exceeds the individual GAWR weights.

## Calculating Load Limits

1. Locate the statement “The combined weight of occupants and cargo should never exceed XXX lbs or XXX kg” on the “Tire and Loading Information” label.
2. Determine the combined weight of all occupants that will ride in the vehicle.
3. Subtract the combined weight of the occupants from XXX lbs or XXX kg (see Step 1).
4. The resulting figure equals the available cargo load capacity. For example, if the “XXX” amount equals 1400 lbs (635 kg) and there will be five 150 lb (68 kg) passengers in the vehicle, the amount of available cargo capacity is 650 lbs (1400 - 750 (5 x 150) = 650 lbs) or 295 kg (635 - 340 (5 x 68) = 295 kg).
5. Determine the combined cargo weight being loaded on the vehicle. That weight must not exceed the available cargo load capacity calculated in Step 4.

**⚠ Warning:** Trunks are the preferred places to carry objects. In a collision, or during hard braking and sharp turns, loose items in the cabin could injure occupants.

### Example Load Limit Calculations

How much cargo Model Y can carry depends on the number and weight of passengers. The following calculated load limit examples assume passengers weigh 150 lbs (68 kg). If passengers weigh more or less, available cargo weight decreases or increases respectively.

#### Driver and one passenger

Description	Total
Vehicle capacity weight	954 lbs (433 kg)

Description	Total
Subtract occupant weight (2 x 150 lbs/68 kg)	300 lbs (136 kg)
Available cargo weight	654 lbs (297 kg)

#### Driver and four passengers

Description	Total
Vehicle capacity weight	954 lbs (433 kg)
Subtract occupant weight (5 x 150 lbs/68 kg)	750 lbs (340 kg)
Available cargo weight	204 lbs (93 kg)

The cargo weight should be distributed between the front and rear trunks.

**⚠ Caution:** Do not exceed the maximum front trunk load weight of 55 lbs (25 kg).

**⚠ Caution:** Never load more than 130 lbs (60 kg) on the rear load floor (above the lower trunk compartment) or more than 285 lbs (130 kg) in the lower trunk compartment. Doing so can cause damage.

## Roof Racks

Model Y supports the use of Tesla-approved roof racks using a Tesla mounting accessory. To install roof racks, you must use this accessory and you must use only roof rack systems that have been approved by Tesla (see [Parts and Accessories](#) on page 184). Failure to do so can cause significant damage.



## Exterior Dimensions

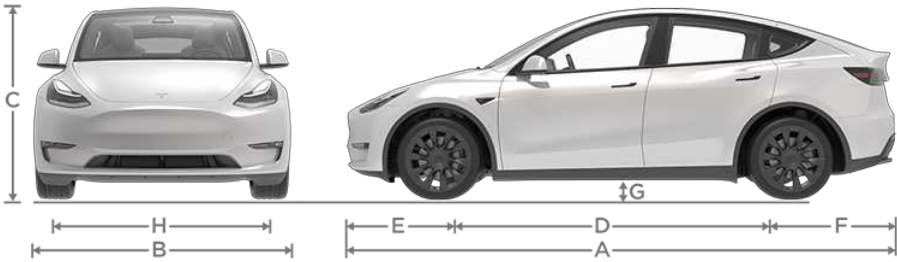

A	Overall Length	187 in	4,751 mm
B	Overall Width (including mirrors)	83.8 in	2,129 mm
	Overall Width (including folded mirrors)	77.9 in	1,978 mm
	Overall Width (excluding mirrors)	75.6 in	1,921 mm
C	Overall Height - coil suspension	63.9 in	1,624 mm
D	Wheel Base	113.8 in	2,890 mm
E	Overhang - Front	34.4 in	847 mm
F	Overhang - Rear	38.8 in	986 mm
G	Ground Clearance - coil suspension	6.6 in	167 mm
H	Track, non 21" wheels - Front	64.4 in	1,636 mm
	Track, non 21" wheels - Rear	64.4 in	1,636 mm
	Track, 21" wheels - Front	64.8 in	1,646 mm
	Track, 21" wheels - Rear	65.2 in	1,656 mm

\*Values are approximate. Dimensions can vary depending on a vehicle's options and various other factors.

## Interior Dimensions

Head Room	Front	41.0 in	1,041 mm
	Rear	39.4 in	1,001 mm
Leg Room	Front	41.8 in	1,063 mm
	Rear	40.5 in	1,029 mm
Shoulder Room	Front	56.4 in	1,432 mm
	Rear	54 in	1,373 mm
Hip Room	Front	53.8 in	1,367 mm
	Rear	50.6 in	1,286 mm



## Cargo Volume

Total enclosed cargo volume	68 cu ft
-----------------------------	----------

## Weights

Curb Weight* Long Range Battery, Dual Motor	4,416 lbs	2,003 kg
Curb Weight* Long Range Battery, Performance Dual Motor	4,416 lbs	2,003 kg
GVWR** Long Range Battery, Dual Motor	5,302 lbs	2,405 kg
GVWR** Long Range Battery, Performance Dual Motor	5,302 lbs	2,405 kg
Gross Vehicle Weight Distribution - Dual Motor	Front: 46%	Rear: 54%
Gross Axle Weight Rating - Front, 19" wheels	3,607 lbs	1,636 kg
Gross Axle Weight Rating - Rear, 19" wheels	3,607 lbs	1,636 kg
Gross Axle Weight Rating - Front, 20" wheels	3,307 lbs	1,500 kg
Gross Axle Weight Rating - Rear, 20" wheels	3,307 lbs	1,500 kg
Gross Axle Weight Rating - Front, 21" wheels	3,005 lbs	1,363 kg
Gross Axle Weight Rating - Rear, 21" wheels	3,505 lbs	1,590 kg
Towing Capacity (if equipped)	Model Y is not equipped with towing.	
*Curb Weight = weight of the vehicle with correct fluid levels, no occupants and no cargo		
**GVWR = Gross Vehicle Weight Rating		
<b>Note:</b> Values are approximate. Weights can vary depending on a vehicle's options.		



## Motor Type

Rear motor: AC permanent magnet synchronous motor, liquid-cooled, with variable frequency drive.

Front motor: AC induction motor, liquid-cooled, with variable frequency drive.



## Transmission

Type	Single speed fixed gear
Gearbox Ratio	9:1

## Steering

Type	Rack and pinion with electronic power steering, speed sensitive
Number of turns lock to lock	2.00
Turning Circle (curb to curb)	39.8 ft (12.1 m)

## Brakes

Type	4-wheel anti-lock braking system (ABS) with Electronic Brake Force Distribution, Integrated Advanced Stability Control and Electronic Accelerator pedal actuated regenerative braking system
Calipers	Front: Four piston fixed Rear: Integrated Electronic Parking Brake Sliding
Rotor Diameter (ventilated)	Front (non-Performance): 14.0"/355 mm Front (Performance): 14.0"/355 mm Rear (non-Performance): 13.2"/335 mm Rear (Performance): 13.2"/335 mm
Front Rotor thickness	New (non-performance): 0.98"/25 mm New (performance): 1.06" / 27 mm Service limit (non-performance): 0.91"/23 mm Service limit (performance): 0.98" / 25 mm
Rear Rotor thickness	New (non-performance): 0.79"/20 mm New (performance): 0.87" / 22 mm Service limit (non-performance): 0.71"/18 mm Service limit (performance): 0.79" / 20 mm
Front Brake Pad Thickness (excluding back plate)	New: 0.393"/10 mm Service limit: 0.085"/2.15 mm
Rear Brake Pad Thickness (excluding back plate)	New: 0.354"/9 mm Service limit: 0.078"/2 mm
Performance Front Brake Pad Thickness (excluding back plate)	New: 0.393"/10 mm Service limit: 0.085"/2.15 mm





Performance Rear Brake Pad Thickness (excluding back plate)	New: 0.354"/ 9 mm Service limit: 0.071"/ 1.8 mm
Parking brake	Electrically actuated parking brake integrated into rear caliper



## Suspension

Front	Independent, double wishbone, coil spring/telescopic damper, sway bar
Rear	Independent, multi-link, coil spring/telescopic damper

## Battery - 12V

Rating	33 amp hour or higher
Voltage and Polarity	12V negative (-) ground

## Battery - High Voltage

Type	Liquid-cooled lithium ion (Li-ion)
Nominal Voltage	360 V DC
Temperature Range	Do not expose Model Y to ambient temperatures above 140° F (60° C) or below -22° F (-30° C) for more than 24 hours at a time.



## Wheel Specifications (Factory)

Wheel Diameter	Location	Width (in)	Offset (mm)
19"	Front/Rear	9.5	45
20"	Front/Rear	9.5	45
21"	Front	9.5	40
21"	Rear	10.5	48

Lug Nut Torque	129 lb. ft (175 Nm)
Lug Nut Socket Size	21 mm
<b>Note:</b> For instructions on how to jack/lift Model Y, see <a href="#">Jacking and Lifting</a> on page 183.	



## Tire Specifications (Factory)

Tire Size	Location	Size
19"	Front/Rear	255/45R19
20"	Front/Rear	255/40R20
21"	Front	255/35R21
21"	Rear	275/35R21
Tire pressures vary depending on the type of tires fitted. Refer to the tire pressures printed on the Tire and Loading Information label. This label is located on the center door pillar and is visible when the driver's door is open (see <a href="#">Maintaining Tire Pressures</a> on page 170).		
Winter tires can be purchased from a Tesla store.		



## Understanding Tire Markings

Laws require tire manufacturers to place standardized information on the sidewall of all tires. This information identifies and describes the fundamental characteristics of the tire. It also provides the tire identification number (TIN) for certification of safety standards, and in case of a recall.



1	Tire category. P indicates that the tire is for passenger vehicles.
2	Tire width. This 3-digit number is the width (in millimeters) of the tire from sidewall edge to sidewall edge.
3	Aspect ratio. This 2-digit number is the sidewall height as a percentage of the tread width. So, if the tread width is 205 mm, and the aspect ratio is 50, the sidewall height is 102 mm.
4	Tire construction. R indicates that the tire is of Radial ply construction.
5	Wheel diameter. This 2-digit number is the diameter of the wheel rim in inches.
6	Load index. This 2 or 3-digit number is the weight each tire can support. This number is not always shown.
7	Speed rating. When stated, indicates the maximum speed (in mph) at which the tire can be used for extended periods. Q=99 mph (160 km/h), R=106 mph (170 km/h), S=112 mph (180 km/h), T=118 mph (190 km/h), U=124 mph (200 km/h), H=130 mph (210 km/h), V=149 mph (240 km/h), W=168 mph (270 km/h), Y=186 mph (300 km/h).



8	Load range. Shown as Standard Load (SL) or Extra Load (XL), the load range determines how much weight your tires can support at a specified tire pressure. When replacing tires, only use tires of the same load range. If towing with snow tires, ensure they are the same load range of the tires your vehicle came equipped with.
9	Tire composition and materials. The number of plies in both the tread area and the sidewall area indicates how many layers of rubber coated material make up the structure of the tire. Information is also provided on the type of materials used.
10	Maximum tire load. The maximum load which can be carried by the tire.
11	Maximum permissible inflation pressure. This pressure should not be used for normal driving.
12	U.S. DOT Tire Identification Number (TIN). Begins with the letters DOT and indicates that the tire meets all federal standards. The next 2 digits/letters represent the plant code where it was manufactured, and the last 4 digits represent the week and year of manufacture. For example, the number 1712 is used to represent the 17th week of 2012. The other numbers are marketing codes used at the manufacturer's discretion. This information can be used to contact consumers if a tire defect requires a recall.
13	Treadwear grade. This number indicates the tire's wear rate. The higher the treadwear number is, the longer it should take for the tread to wear down. A tire rated at 400, for example, lasts twice as long as a tire rated at 200.
14	Traction grade. Indicates a tire's ability to stop on wet roads. A higher graded tire should allow you to stop your vehicle in a shorter distance than a tire with a lower grade. Traction is graded from highest to lowest as AA, A, B, and C.
15	Temperature grade. The tire's resistance to heat is grade A, B, or C, with A indicating the greatest resistance. This grading is provided for a correctly inflated tire, which is being used within its speed and loading limits.



## Uniform Tire Quality Grading

The following information relates to the tire grading system developed by the National Highway Traffic Safety Administration (NHTSA), which grades tires by tread wear, traction and temperature performance. Tires that have deep tread, and winter tires, are exempt from these marking requirements.

Where applicable, quality grades are found on the tire's sidewall between the tread shoulder and maximum section width. For example:

- TREADWEAR 180
- TRACTION AA
- TEMPERATURE A

The quality grades are described next.

**Note:** In addition to the marking requirements, passenger car tires must conform to Federal Safety Requirements.

### Treadwear

The treadwear grade is a comparative rating based on the wear rate of the tire when tested under controlled conditions on a specified government test course.

For example, a tire graded 150 wears one and a half times better on a government test course than a tire graded 100. The relative performance of tires depends on the actual conditions of their use, however, and can depart significantly from the norm due to variations in driving habits, service practices, road characteristics, and climate.

### Traction

The traction grades, from highest to lowest, are: AA, A, B, and C. These grades represent a tire's ability to stop on wet pavement as measured under controlled conditions on test surfaces of asphalt and concrete. A tire marked C might have poor traction performance.

**Warning:** Defective tires are dangerous. Do not drive if a tire is damaged, excessively worn, or is inflated to an incorrect pressure. The safety of the vehicle and occupants can be adversely affected. Check tires regularly for wear and to ensure there are no cuts, bulges or exposure of the ply/cord structure.

**Warning:** The traction grade assigned to the tire is based on straight-ahead braking tests, and does not include:

acceleration, cornering, hydroplaning or peak traction characteristics.

### Temperature

The temperature grades are A (the highest), B, and C, representing the tire's resistance to the generation of heat and its ability to dissipate heat when tested under controlled conditions on a specified indoor laboratory test wheel. Sustained high temperature can cause the tire to degenerate and reduce tire life, and excessive temperature can lead to sudden tire failure.

The grade C corresponds to the minimum level of performance that all passenger car tires must meet under the Federal Motor Safety Standard No. 109. Grades B and A represent levels of performance on the laboratory test wheel that exceed the minimum requirements.

**Warning:** A tire's temperature grade is established for a tire that is properly inflated and not overloaded. Excessive speed, under-inflation, or excessive loading, either separately or in combination, can cause heat buildup and possible tire failure.



## Tire and Loading Glossaries

### General Wheel and Tire Terms

Accessory Weight	The combined weight (in excess of those items replaced) of items available as factory installed equipment.
Bead	The inner edge of a tire that is shaped to fit to the rim and form an air tight seal. The bead is constructed of steel wires which are wrapped, or reinforced, by the ply cords.
Cold Tire Pressure	The air pressure in a tire that has been standing in excess of three hours, or driven for less than one mile.
Curb Weight	The weight of a standard vehicle, including any optional equipment fitted, and with the correct fluid levels.
Gross Vehicle Weight	The maximum permissible weight of a vehicle with driver, passengers, load, luggage, and equipment.
kPa (kilo pascal)	A metric unit used to measure pressure. One kilo pascal equals approximately 0.145 psi.
Maximum Inflation Pressure	The maximum pressure to which the tire should be inflated. This pressure is given on the tire side wall in psi (lbf/in <sup>2</sup> ). <b>⚠ Caution:</b> This pressure marked on the tire is the maximum allowed by the tire manufacturer. It is not the pressure Tesla recommends using for Model Y.
Maximum Loaded Vehicle Weight	The sum of curb weight, accessory weight, vehicle capacity weight, and production options weight.
Production Options Weight	The combined weight of options installed which weigh in excess of 3 lb more than the standard items that they replaced, and are not already considered in curb or accessory weights.
PSI (lbf/in <sup>2</sup> )	Pounds per square inch (the unit used to measure tire pressure).
Recommended Tire Inflation Pressure	Tire inflation pressure, established by Tesla, which is based on the type of tires that are mounted on the vehicle at the factory. This information can be found on the Tire and Loading Information label located on the door pillar.
Rim	The metal support for a tire, or tire and tube, upon which the tire beads are seated.
Vehicle Capacity Weight	The number of seats multiplied by 150 lbs plus the rated amount of load/luggage.

### Load Carrying Definitions

Normal occupant weight	68 kilograms (150 lbs) times the number of occupants specified in the second column of the tables for calculating load limits (see <a href="#">Vehicle Loading</a> on page 186).
Occupant distribution	Distribution of occupants in a vehicle.
Passenger car tire	A tire intended for use on passenger cars, multipurpose passenger vehicles, and trucks, that have a gross vehicle weight rating (GVWR) of 10,000 pounds or less.





Rim diameter	Nominal diameter of the bead seat.
Rim size designation	Rim diameter and width.
Rim type designation	The manufacturing industry's designation for a rim by style or code.
Rim width	Nominal distance between the rim's flanges.
Vehicle maximum load on the tire	Load on an individual tire that is determined by distributing to each axle its share of the maximum loaded vehicle weight and dividing by two.
Vehicle normal load on the tire	Load on an individual tire that is determined by distributing to each axle its share of the curb weight, accessory weight, and normal occupant weight and dividing by two.

## Pneumatic Radial Tire Definitions

Bead separation	A breakdown of the bond between components in the bead.
Bias ply tire	A pneumatic tire in which the ply cords that extend to the beads are laid at alternate angles substantially less than 90 degrees to the center line of the tread.
Carcass	The tire structure, except tread and sidewall rubber which, that when inflated, bears the load.
Chunking	The breaking away of pieces of the tread or sidewall.
Cord	The strands forming the plies in the tire.
Cord separation	The parting of cords from adjacent rubber compounds.
Cracking	Any parting within the tread, sidewall, or inner liner of the tire extending to cord material.
Extra load tire	A tire designed to operate at higher loads and higher inflation pressure than the corresponding standard tire.
Groove	The space between two adjacent tread ribs.
Inner liner	The layer(s) forming the inside surface of a tubeless tire that contains the inflating medium within the tire.
Inner liner separation	The parting of the inner liner from cord material in the carcass.
Load rating	The maximum load that a tire is rated to carry for a given inflation pressure.
Maximum load rating	The load rating for a tire at the maximum permissible inflation pressure for that tire.
Measuring rim	The rim on which a tire is fitted for physical dimension requirements.
Open splice	Any parting at any junction of tread, sidewall, or inner liner that extends to the cord material.
Outer diameter	The overall diameter of an inflated new tire.



Overall width	The linear distance between the exteriors of the sidewalls of an inflated tire, including elevations due to labeling, decorations, or protective bands or ribs.
Ply	A layer of rubber-coated parallel cords.
Ply separation	A parting of rubber compound between adjacent plies.
Pneumatic tire	A mechanical device made of rubber, chemicals, fabric and steel or other materials, that, when mounted on an automotive wheel, provides the traction and contains the gas or fluid that sustains the load.
Radial ply tire	A pneumatic tire in which the ply cords that extend to the beads are laid at substantially 90 degrees to the center line of the tread.
Reinforced tire	A tire designed to operate at higher loads and at higher inflation pressures than the corresponding standard tire.
Section width	The linear distance between the exteriors of the sidewalls of an inflated tire, excluding elevations due to labeling, decoration, or protective bands.
Sidewall	The portion of a tire between the tread and bead.
Sidewall separation	The parting of the rubber compound from the cord material in the sidewall.
Snow tire	A tire that attains a traction index equal to or greater than 110, compared to the ASTM E1136-93 (re-approved 2003, incorporated by reference, see §571.5) Standard Reference Test Tire when using the snow traction test as described in ASTM F1805-00 (incorporated by reference, see §571.5), and that is marked with an Alpine Symbol specified in S5.5(i) on at least one sidewall.
Test rim	The rim on which a tire is fitted for testing, and may be any rim listed as appropriate for use with that tire.
Tread	The portion of a tire that comes into contact with the road.
Tread rib	A tread section running around the circumference of a tire.
Tread separation	The pulling away of the tread from the tire carcass.
Tread wear indicators (TWI)	The projections within the principal grooves designed to give a visual indication of the degrees of wear of the tread.
Wheel-holding fixture	The fixture used to hold the wheel and tire assembly securely during testing.



# Contacting Tesla Roadside Assistance

Tesla Roadside Assistance is available to you, 24 hours a day, 365 days a year, for the duration of your warranty period.

When contacting Tesla Roadside Assistance, please provide:

- The Vehicle Identification Number (VIN). The VIN is displayed when you touch the Tesla "T" at the top of the touchscreen. The VIN can also be seen on the upper dashboard by looking through the driver's side of the windshield.
- Your exact location.
- The nature of the problem.

Tesla Roadside Assistance is available to speak with roadside service professionals 24/7/365 to answer any questions and explain the proper procedure for transporting your Model Y.

**Note:** For a detailed description of Tesla's Roadside Assistance policy, go to the support page on the Tesla web site for your region.

## Regional Phone Number(s)

Mexico: [1-800-228-8145](tel:1-800-228-8145)

United States and Canada: [1-877-79TESLA \(1-877-798-3752\)](tel:1-877-79TESLA)

**Note:** The phone number is also available by touching the Tesla "T" at the top center of the touchscreen.



## DO NOT TRANSPORT WITH WHEELS ON THE GROUND

The rear motor in Model Y generates power when the wheels spin. Always transport Model Y with all four tires off the ground. Ensure that the tires are unable to spin at any time during transport.

**Warning:** NEVER TRANSPORT YOUR VEHICLE WITH THE TIRES IN A POSITION WHERE THEY CAN SPIN. DOING SO CAN LEAD TO SIGNIFICANT DAMAGE AND OVERHEATING. IN RARE CASES EXTREME OVERHEATING MAY CAUSE THE SURROUNDING COMPONENTS TO IGNITE.



Do not transport Model Y using any method that is not specified by Tesla. Adhere to the instructions provided in the following sections and observe all warnings and cautions provided. Damage caused by improper transporting of your vehicle is not covered by the warranty.

**Note:** Tesla is not liable or responsible for reimbursing services not dispatched through Tesla Roadside Assistance.

### Approved Methods for Transporting

**Note:** The tires are allowed to rotate slowly (under 3 mph or 5 km/h) and for a very short distance (less than 30 feet or 10 meters) only when Transport Mode is enabled (see [Activate Transport Mode](#)) while the vehicle is being winched onto a flatbed truck or pulled out of a parking space for repositioning. Exceeding these boundaries can lead to significant damage and overheating that is not covered by the warranty.

A flatbed truck or comparable transport vehicle is the recommended method of transporting Model Y. The vehicle can face either direction when using a flatbed.



If Model Y must be transported without a flatbed truck, then wheel lifts and dollies must be used to ensure that all four wheels are off of the ground. This method may only be used for a maximum of 35 miles (55 km), and must not exceed the manufacturer speed rating of the dollies. With this method, Tesla recommends the vehicle facing forward so that the front wheels are lifted and the rear wheels are on dollies.



**Caution:** Enable Transport Mode (see [Activate Transport Mode](#)) before winching Model Y onto a flatbed truck (see [Pull Onto Flatbed Truck From Front](#) and [Pull Onto Flatbed Truck From Rear](#)). If Transport Mode is not available or the touchscreen is not accessible, self-loading dollies or tire skates must be used to load the vehicle into the approved transportation position. Tesla is not responsible for any damage caused by or during the transport of Model Y, including personal property damage or damage caused by using self-loading dollies or tire skates.

**Warning:** Model Y is equipped with high voltage components that may be compromised as a result of a collision (see [High Voltage Components](#) on page 158). Before transporting Model Y, it is important to assume these components are energized. Always follow high voltage safety precautions (wearing personal protection equipment, etc.) until emergency response professionals have evaluated the vehicle and can accurately confirm that all high voltage systems are no longer energized. Failure to do so may result in serious injury.



## Activate Transport Mode

Transport Mode keeps the parking brake disengaged while winching Model Y onto a flatbed truck. When active, Transport Mode displays a message indicating that the vehicle will remain free-rolling. The following are required to enable Transport Mode:

- 12V power is required. You are unable to use the touchscreen to activate Transport Mode if Model Y has no power.
- Model Y must detect a key. Transport Mode is available only when a key is detected.

To activate Transport Mode:

1. Ensure the vehicle is in Park.
2. Chock the tires or otherwise ensure Model Y is secure.
3. Press and hold the brake pedal, then on the touchscreen, touch **Controls** > **Service** > **Towing**. The touchscreen displays a message reminding you how to properly transport Model Y.
4. Press and hold the **Transport Mode** button until it turns blue. Model Y is now free-rolling and can slowly be rolled (no faster than walking speed) or winched.

To cancel Transport Mode, shift Model Y into Park.

**Note:** If Model Y loses 12V power after Transport Mode is enabled, Transport Mode will cancel and the parking brake will be re-applied.

- ⚠ Caution:** If the electrical system is not working, and you therefore cannot use the touchscreen to activate Transport Mode, use self-loading dollies or tire skates. Before doing so, always check the manufacturer's specifications and recommended loading capacity.

## Pull Onto Flatbed Truck From Front

**Note:** If Model Y has no 12V power, you need an external 12V power supply to open the hood or use the touchscreen. See [If Vehicle Has No Power](#).

- ⚠ Caution:** To avoid damage, only pull the vehicle onto a flatbed truck using a properly-installed tow eye. Using the chassis, frame, or suspension components to pull the vehicle can result in damage.

1. Locate the tow eye. The tow eye is located in the front trunk.



2. Release the front tow eye cover by pressing firmly on its top right perimeter until it pivots inward, then gently pulling the raised section toward you.

**Note:** The front tow eye cover is connected to the vehicle's black negative (-) terminal.

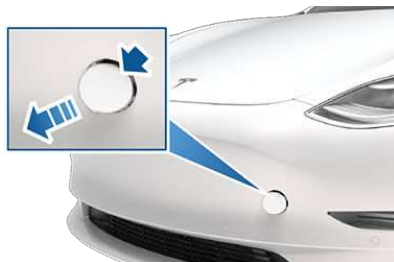

3. Fully insert the tow eye into the opening, then turn it **counter-clockwise** until securely fastened.

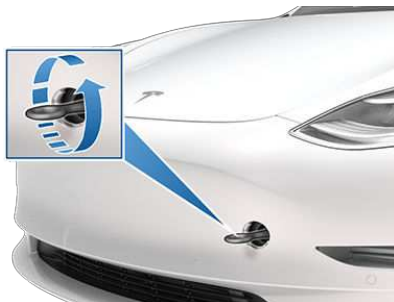

4. Attach the winch cable to the tow eye.
 

**⚠ Caution:** Before pulling, make sure the tow eye is securely tightened.
5. Activate Transport Mode.
6. Pull Model Y slowly onto the flatbed truck.



## Pull Onto Flatbed Truck From Rear

**Note:** If Model Y has no 12V power, you need an external 12V power supply to open the hood or use the touchscreen. See [If Vehicle Has No Power](#).

**⚠ Caution:** To avoid damage, only pull the vehicle onto a flatbed truck using a properly-installed tow eye. Using the chassis, frame, or suspension components to pull the vehicle can result in damage.

1. Locate the tow eye. The tow eye is located in the front trunk.



2. Release the rear tow eye cover by pressing firmly on its top right perimeter until it pivots inward, then gently pulling the raised section toward you.

**Note:** Vehicles equipped with a hitch receiver cannot be pulled from the rear tow eye. Use the tow bar or hitch receiver only to pull the vehicle to a safe location, such as onto a flatbed truck. Do not transport the vehicle with wheels on the ground.

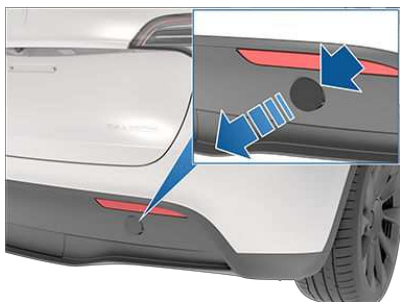

3. Fully insert the tow eye into the opening, then turn it **counter-clockwise** until securely fastened.



4. Attach the winch cable to the tow eye.
  - ⚠ Caution:** Before pulling, make sure the tow eye is securely tightened.
5. Activate Transport Mode.
6. Pull Model Y slowly onto the flatbed truck.

## Secure the Tires

The vehicle's tires must be secured onto the truck using the eight-point tie-down method.

- Ensure any metal parts on the tie-down straps do not contact painted surfaces or the face of the wheels.
- Do not place tie-down straps over body panels or through the wheels.

**⚠ Caution:** Attaching the tie-down straps to the chassis, suspension or other parts of the vehicle's body may cause damage.



## If Vehicle Has No Power

If Model Y has no 12V power, perform the following steps to open the hood or jump start the auxiliary 12V battery.



## Jump Starting the 12V Battery

- ⚠ Caution:** Model Y cannot be used to jump start another vehicle. Doing so can result in damage.

**Note:** If jump starting Model Y using another vehicle, refer to that vehicle manufacturer's instructions. The following instructions assume an external 12V power supply (such as a portable jump starter) is used.

- ⚠ Caution:** Avoid short circuits when jump starting Model Y. Connecting cables to the wrong terminals, touching leads together, etc., can result in damage to Model Y.
1. Open the hood (see [Opening Hood with No Power](#) on page 21).
  2. Remove the maintenance panel by pulling it upwards to release the trim clips that hold it in place.



3. Remove the cabin intake trim panel by pulling it upwards to release the trim clips that hold it in place.

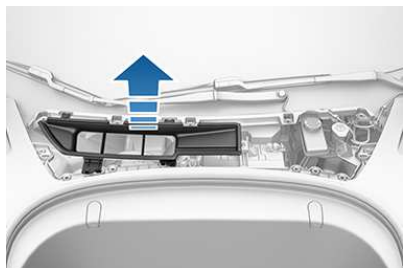

4. Connect the 12V power supply's red positive (+) cable to the red positive (+) terminal on the 12V battery.
  - ⚠ Caution:** To avoid damaging Model Y, do not allow the positive cable to contact other metal components, such as the battery tie-down bracket.

5. Connect the 12V power supply's black negative (-) cable to the black negative (-) terminal on the 12V battery.

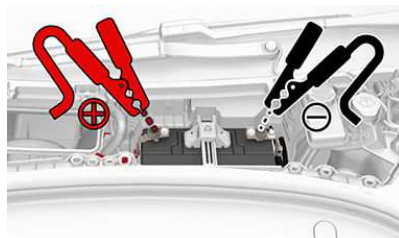

6. Turn on the external power supply (refer to the manufacturer's instructions). Touch the touchscreen to wake it up.

**Note:** It may take several minutes to receive enough power to wake up the touchscreen.

7. When external 12V power is no longer required, disconnect both cables from the terminals on the 12V battery, beginning with the black negative (-) cable.
8. Replace the cabin intake trim panel by placing it back in its original location and pressing down until it is secure.
9. Replace the maintenance panel by placing it back in its original location and pressing down until it is secure.
10. Close the hood.



But wait, there's more! Below is a list of the Easter Eggs that have been discovered so far and how to access them. Alternatively, touch the Tesla "T" (top center of the touchscreen) then drag the **About Your Tesla** box downwards for one-touch access to all discovered Easter Eggs.

**Note:** For a shortcut to Easter Egg fun, touch the Toybox icon in the application launcher (see [Touchscreen Overview](#) on page 4).

For This...	Do This...
Arcade	Feeling nostalgic? While in Park, access games from the app launcher or your Easter Egg tray then select a game from the menu to play. Note that, depending on the game, you may need to use your steering wheel buttons or a USB controller to play.
Santa Mode	"What have you been longing for?" Enjoy the holidays year-round with this one! Simply initiate a voice command (see <a href="#">Using Voice Commands</a> on page 144) and say "Ho Ho Ho". Or, if you are feeling extra sour, you can say "Ho Ho Ho Not Funny" instead.
Rainbow Road	Need more cowbell? Visit Rainbow Road by moving the gear lever fully down four times in quick succession while Autosteer is enabled.
Sketchpad	Triple-tap the Tesla "T" (top center of the touchscreen) and channel your inner Picasso. Show us what you got! Touch <b>Publish</b> to submit your artistic compositions to Tesla for critiquing.
Mars	Press and hold the Tesla "T" (top center of the touchscreen) then enter <b>mars</b> in the access code popup. The map shows your Model Y as a rover on the Martian landscape, and the <b>About Your Tesla</b> box displays SpaceX's interplanetary spaceship.
The Answer to the Ultimate Question of Life, The Universe, and Everything	Rename your car to <b>42</b> (see <a href="#">Naming Your Vehicle</a> on page 125) and notice the new name of your Model Y.
Romance Mode	You can't roast chestnuts by an open fire in your car, but you can still cozy up with your loved ones by this virtual fireplace. While in Park, access Romance Mode from your Easter Egg tray. Queue the music and get your romance on!
Emissions Testing Mode	Holiday fun can come in surprising ways. Access Emissions Testing Mode from your Easter Egg tray, then select your preferred fart style and a target seat. Activate by pressing the left scroll wheel button when you're ready to "release" your prank.
TRAX	It's never too late to follow your dream of becoming a world-famous DJ. With TRAX, you can turn your vehicle into your own personal music studio. While in Park, choose from an array of instruments and unique sounds to create the next hit song. Access TRAX through your Easter Egg tray on the touchscreen and get jamming. Microphone and headset not included (depending on vehicle configuration and market region, this may not be available on your vehicle).





## Document Applicability

Owner information is updated regularly to reflect updates to your vehicle. However, in some cases, recently released features may not be described. To display information about recently released features, view the Release Notes on the touchscreen. Release Notes are displayed on the touchscreen after a software update, and can be displayed at any time by touching the Tesla "T" at the top of the touchscreen, then touching the Release Notes link. Release notes can also be accessed by navigating to **Controls > Software**. If information related to how to use the touchscreen conflicts with information in the Release Notes, the Release Notes take precedence.

## Illustrations

Illustrations are provided for demonstration purposes only. Depending on vehicle options, software version, region of purchase, and specific settings, your vehicle may appear slightly different. Although the owner information is applicable to both right-hand drive and left-hand drive vehicles, many illustrations show only left-hand drive vehicles. However, the essential information that the illustrations are providing is correct.

## Feature Availability

Some features are available only on some vehicle configurations and/or only in specific market regions. Options or features mentioned in the owner information does not guarantee they are available on your specific vehicle.

## Errors or Inaccuracies

All specifications and descriptions are known to be accurate at time of publishing. However, because continuous improvement is a goal at Tesla, we reserve the right to make product modifications at any time. To communicate any inaccuracies or omissions, or to provide general feedback or suggestions regarding the quality of this owner information, send an email to [OwnersManualFeedback@Tesla.com](mailto:OwnersManualFeedback@Tesla.com).

## Location of Components

Owner information may specify the location of a component as being on the left or right side of the vehicle. As shown, left (1) and right (2) represent the side of the vehicle when sitting inside.



## Copyrights and Trademarks

© 2013-2020 Tesla, Inc. All information in this document and all vehicle software is subject to copyright and other intellectual property rights of Tesla, Inc. and its licensors. This material may not be modified, reproduced or copied, in whole or in part, without the prior written permission of Tesla, Inc. and its licensors. Additional information is available upon request. Tesla uses software created by the Open Source community. Please visit Tesla's Open Source software website at [www.tesla.com/opensource](http://www.tesla.com/opensource). HD Radio is a registered trademark of iBiquity Digital Corporation. The following are trademarks or registered trademarks of Tesla, Inc. in the United States and other countries:

TESLA



TESLA MOTORS

TESLA ROADSTER



MODEL S

MODEL X

MODEL 3

MODEL Y

T E S L A





All other trademarks contained in this document are the property of their respective owners and their use herein does not imply sponsorship or endorsement of their products or services. The unauthorized use of any trademark displayed in this document or on the vehicle is strictly prohibited.



## Event Data Recorder (EDR)

Model Y is equipped with an event data recorder (EDR). The main purpose of an EDR is to record, in certain crash or near crash-like situations, such as an air bag deployment or hitting a road obstacle, data that will assist in understanding how a vehicle's systems performed. The EDR is designed to record data related to vehicle dynamics and safety systems for a short period of time, typically 30 seconds or less. The EDR in Model Y is designed to record data such as:

- How various systems in your vehicle were operating;
- Whether or not the driver and passenger safety belts were buckled/fastened;
- How far (if at all) the driver was depressing the accelerator and/or brake pedal; and,
- How fast the vehicle was traveling.

The data can help provide a better understanding of the circumstances in which crashes and injuries occur.

**Note:** EDR data is recorded by your vehicle only if a non-trivial crash situation occurs; no data is recorded by the EDR under normal driving conditions and no personal data (e.g., name, gender, age, and crash location) is recorded. However, other parties, such as law enforcement, could combine the EDR data with the type of personally identifying data routinely acquired during a crash investigation.

To read data recorded by an EDR, special equipment is required, and access to the vehicle or the EDR is needed. In addition to the vehicle manufacturer, other parties, such as law enforcement, that have the special equipment, can read the information if they have access to the vehicle or the EDR. Tesla may also access the EDR remotely in some crash circumstances.

## Vehicle Telematics

Model Y is equipped with electronic modules that monitor and record data from various vehicle systems, including the motor, Autopilot components, Battery, braking and electrical systems. The electronic modules record information about various driving and vehicle conditions, including braking, acceleration, trip and other related information regarding your vehicle. These modules also record information about the vehicle's features such as charging events and status, the enabling/disabling of various systems, diagnostic trouble codes, VIN, speed, direction and location.

The data is stored by the vehicle and may be accessed, used and stored by Tesla service technicians during vehicle servicing or periodically transmitted to Tesla wirelessly through the vehicle's telematics system. This data may be used by Tesla for various purposes, including, but not limited to: providing you with Tesla telematics services; troubleshooting; evaluation of your vehicle's quality, functionality and performance; analysis and research by Tesla and its partners for the improvement and design of our vehicles and systems; to defend Tesla; and as otherwise may be required by law. In servicing your vehicle, Tesla can potentially resolve issues remotely simply by reviewing your vehicle's data log.

Tesla's telematics system wirelessly transmits vehicle information to Tesla on a periodic basis. The data is used as previously described and helps ensure the proper maintenance of your vehicle. Additional Model Y features may use your vehicle's telematics system and the information provided, including features such as charging reminders, software updates, and remote access to, and control of, various systems of your vehicle.

Tesla does not disclose the data recorded in your vehicle to any third party except when:

- An agreement or consent from the vehicle's owner (or the leasing company for a leased vehicle) is obtained.
- Officially requested by the police or other authorities.
- Used as a defense for Tesla.
- Ordered by a court of law.
- Used for research purposes without disclosing details of the vehicle owner or identification information.



- Disclosed to a Tesla affiliated company, including their successors or assigns, or our information systems and data management providers.

For additional information regarding how Tesla processes data collected from your vehicle, please review Tesla's privacy policy at <http://www.tesla.com/about/legal>.

## Data Sharing

For quality assurance and to support the continuous improvement of advanced features such as Autopilot, Tesla measures road segment data of all participating vehicles. All Tesla vehicles can learn from the experience of the billions of miles that Tesla vehicles have driven. Although Tesla shares this data with partners that contribute similar data, the data does not include any personally identifiable information about you or your vehicle. To allow data sharing, touch **Controls > Safety & Security > Data Sharing**, touch the **Yes** buttons to confirm that you agree to allow Tesla to collect the associated type of data, then submit your response.

For additional information regarding how Tesla processes data collected from your vehicle, please review Tesla's privacy policy at <http://www.tesla.com/about/legal>.

**Note:** Although Model Y uses GPS in connection with driving and operation, as discussed in this owner's manual, Tesla does not record or store vehicle-specific GPS information, except the location where a crash occurred. Consequently, Tesla is unable to provide historical information about a vehicle's location (for example, Tesla is unable to tell you where Model Y was parked/traveling at a particular date/time).

## Quality Control

You might notice a few miles/km on the odometer when you take delivery of your Model Y. This is a result of a comprehensive testing process that ensures the quality of your Model Y.

The testing process includes extensive inspections during and after production. The final inspection takes place at Tesla and includes a road test conducted by a technician.

## California Proposition 65

**Warning:** Operating, servicing and maintaining a passenger vehicle or off-highway motor vehicle can expose you to chemicals including phthalates and lead, which are known to the State of California to cause cancer and birth defects or other reproductive harm. To minimize exposure, wear gloves or wash your hands frequently when servicing your vehicle. For more information go to: [www.P65Warnings.ca.gov/passenger-vehicle](http://www.P65Warnings.ca.gov/passenger-vehicle).

**Warning:** Certain components of this vehicle such as airbag modules and seat belt pre-tensioners may contain Perchlorate Material. Special handling may be required for service or vehicle end of life disposal. See [www.dtsc.ca.gov/hazardouswaste/perchlorate](http://www.dtsc.ca.gov/hazardouswaste/perchlorate).

**Warning:** Battery posts, terminals, and related accessories contain lead and lead compounds. Wash hands after handling.



## Contacting Tesla

For detailed information about your Model Y, go to [www.tesla.com](http://www.tesla.com), and log on to your Tesla Account, or sign up to get an account.

If you have any questions or concerns about your Model Y, call 1-877-79TESLA (1-877-798-3752).

**Note:** You can also use voice commands to provide feedback to Tesla. Say "Note", "Report", "Bug note", or "Bug report" (in the English language) followed by brief comments in your language of choice. Model Y takes a snapshot of its systems, including your current location, vehicle diagnostic data, and screen captures of the touchscreen. Tesla periodically reviews these notes and uses them to continue improving Model Y.

## Reporting Safety Defects - US

If you believe that Model Y has a defect which could cause a crash or could cause injury or death, you should immediately inform the National Highway Traffic Safety Administration (NHTSA) in addition to notifying Tesla.

If NHTSA receives similar complaints, it may open an investigation. If it finds that a safety defect exists in a group of vehicles, it may order a recall and remedy campaign. However, NHTSA cannot become involved in individual problems between you, your dealer, or Tesla.

To contact NHTSA, you may call the Vehicle Safety Hotline toll-free at 1-888-327-4236 (TTY: 1-800-424-9153); go to [www.safercar.gov](http://www.safercar.gov); or write to: Administrator, National Highway Traffic Safety, 1200 New Jersey Avenue SE., Washington, DC 20590. You can also obtain other information about motor vehicle safety from [www.safercar.gov](http://www.safercar.gov).

## Reporting Safety Defects - Canada

If you believe that your Model Y has a defect which could cause a crash or could cause injury or death, you should immediately inform Transport Canada, in addition to notifying Tesla. To contact Transport Canada, call their toll-free number: 1-800-333-0510.



## FCC and IC Certification

Component	Manufacturer	Model	Operating Frequency (MHz)	FCC ID	IC ID
B-Pillar Endpoint	Tesla	1509518	13.56 2400-2483.5	2AEIM-1509518	20098-1509518
Center Console	Tesla	1089774	13.56 2400-2483.5	2AEIM-1089774	20098-1089774
Rear Endpoint	Tesla	1509516	2400-2483.5	2AEIM-1509516	20098-1509516
Key fob	Tesla	1133148	2400-2483.5	2AEIM-1133148	20098-1133148
TPMS	Tesla	1472547	2400-2483.5	2AEIM-1472547	20098-1472547
Radar	Continental	ARS 4-B	76000-77000	OAYARS4B	4135A-ARS4B
Homelink	Gentex	ADHL5C	286-440MHz	NZLADHL5C	4112A-ADHL5C
CarPC	Tesla	1506277	--	YZP-RBHP-B216C RI7LE940B6NA	RBHP-B216C 5131A-LE940B6NA
Wireless Charger	Tesla	WC2	--	2AEIM-WC2	20098-WC2

The devices listed above comply with Part 15 of the FCC rules and Industry Canada's license-exempt RSS Standard(s) and EU Directive 2014/53/EU.

Operation is subject to the following two conditions:

1. This device may not cause harmful interference; and
2. This device must accept any interference received, including interference that may cause undesired operation.

Changes or modifications not expressly approved by Tesla could void your authority to operate the equipment.



## Radio Frequency Information

This equipment has been tested and found to comply with the limits for a Class B digital device, pursuant to Part 15 of the FCC Rules. These limits are designed to provide reasonable protection against harmful interference in a residential installation. This equipment generates, uses and can radiate radio frequency energy and, if not installed and used in accordance with the instructions, may cause harmful interference to radio communications. However, there is no guarantee that interference will not occur in a particular installation. If this equipment does cause harmful interference to radio or television reception, which can be determined by turning the equipment off and on, try to correct the interference by one or more of the following measures:

- Reorient or relocate the receiving antenna.
- Increase the separation between the equipment and receiver.
- Connect the equipment into an outlet on a circuit different from that to which the receiver is connected.
- Consult the dealer or an experienced radio/TV technician to help.

**⚠ Caution:** This equipment and its antennas must not be co-located or operated with another antenna or transmitter.

## Radiation Exposure Statement

The products comply with the FCC/IC RF Exposure for Low Power Consumer Wireless Power Transfer. RF exposure limits are set forth for an uncontrolled environment and are safe for intended operation as described in this manual. The farthest RF exposure demonstrated by compliance was at 20cm and farther from the user's body; set the device to low output power if such function is available.

## Canada

CAN ICES-3 (B)/NMB-3(B)

Le présent appareil est conforme aux CNR d'Industrie Canada applicables aux appareils radioexempts de licence. L'exploitation est autorisée aux deux conditions suivantes : (1) l'appareil ne doit pas produire de brouillage, et (2) l'utilisateur de l'appareil doit accepter tout brouillage radioélectrique subi, même si le brouillage est susceptible d'en compromettre le fonctionnement.

Cet équipement est conforme aux limites d'exposition aux rayonnements IC établies pour un environnement non contrôlé.

### Déclaration d'exposition aux radiations

Le produit est conforme à l'exposition RF IC pour le transfert de puissance sans fil de consommateurs de faible puissance. La limite d'exposition RF fixée pour un environnement non contrôlé est sans danger pour le fonctionnement prévu tel que décrit dans ce manuel. L'exposition RF supplémentaire que la conformité a été démontrée à 20cm et plus de séparation du corps de l'utilisateur ou de mettre l'appareil à la puissance de sortie inférieure si une telle fonction est disponible.



## Charging equipment fault Try different charging equipment(CP\_a004)

The charge port is unable to detect whether a charge cable is inserted or the type of charge cable connected.

If this alert appears while a charge cable **is** connected, it should be determined whether the issue is caused by the charging equipment or the vehicle. Try charging the vehicle using different external charging equipment (charge cable, charging station, charging stall, etc.).

- If the vehicle begins charging, the issue was likely with the equipment.
- If the vehicle still does not charge, the issue may be with the vehicle.

If this alert appears while a charge cable is **not** connected or if the issue is suspected to be with the vehicle, inspect the charge port inlet and the charge cable connector for any obstructions (use a flashlight as necessary). Debris, moisture, and/or foreign objects present in the charge port inlet or the charge cable connector can prevent the charge port from properly detecting charge cables. If any obstruction is found:

1. Remove the debris / foreign object or dry any moisture.
2. Try re-inserting the cable into the charge port. Charging should now be possible.

Service should only be scheduled if any of the following conditions are present:

- This alert has appeared / remains present and the vehicle has been unable to charge with multiple, different charging equipment.
- This alert has appeared / remains present without any charging equipment connected after any charge port inlet obstruction has been removed or no obstruction was found.

For more information on charging, see [Charging Instructions](#) on page 162.

## Unable to charge Check charging equipment(CP\_a046)

The charge port is unable to detect whether a charge cable is inserted or the type of charge cable connected.

If this alert appears while a charge cable **is** connected, it should be determined whether the issue is caused by the charging equipment or the vehicle. Try charging the vehicle using different external charging equipment (charge cable, charging station, charging stall, etc.).

- If the vehicle begins charging, the issue was likely with the equipment.
- If the vehicle still does not charge, the issue may be with the vehicle.

If this alert appears while a charge cable is **not** connected or if the issue is suspected to be with the vehicle, inspect the charge port inlet and the charge cable connector for any obstructions (use a flashlight as necessary). Debris, moisture, and/or foreign objects present in the charge port inlet or the charge cable connector can prevent the charge port from properly detecting charge cables. If any obstruction is found:

1. Remove the debris / foreign object or dry any moisture.
2. Try re-inserting the cable into the charge port. Charging should now be possible.

Service should only be scheduled if any of the following conditions are present:

- This alert has appeared / remains present and the vehicle has been unable to charge with multiple, different charging equipment.
- This alert has appeared / remains present without any charging equipment connected after any charge port inlet obstruction has been removed or no obstruction was found.

For more information on charging, see [Charging Instructions](#) on page 162.

## AC charging interrupted Check power source or charging equipment(CP\_a055)

Charging stopped because communication between the vehicle and the external charging equipment was interrupted.

Confirm whether the external charging equipment is powered by looking for any status lights, displays, or other indicators on the equipment.

If the equipment is **not** powered, try to restore the external charging equipment's power source.





- If attempting to charge at a public station and power is unable to be restored, contact the station operator.
- If attempting to charge at a private station (for example: charging at home) and power is unable to be restored, contact an electrician.

If the equipment is powered, try charging the vehicle using different external charging equipment.

- If the vehicle begins charging, the issue was likely with the equipment.
- If the vehicle still does not charge, the issue may be with the vehicle.

Service should only be scheduled if this alert has appeared / remains present when the equipment is powered and the vehicle has been unable to charge with multiple, different charging equipment.

For more information on troubleshooting Mobile Connector or Wall Connector status lights, refer to the product's Owner's Manual. If using other external charging equipment, refer to the manufacturer's provided documentation for troubleshooting tips.

## Charge port latch not engagedFully insert charge cable or check for obstruction(CP\_a054)

The charge port latch is unable to latch the charge cable in the charge port inlet. If the latch is not engaged, AC charging (for example, charging with a Tesla Mobile Connector or Wall Connector) will be limited to 16A and DC Fast Charging / Supercharging will be unavailable.

The charge port light will pulse amber if this alert appears during AC charging and will be solid amber if this alert appears when attempting to DC Fast Charge / Supercharge.

Try re-inserting the charge cable fully into the charge port inlet.

- If the vehicle begins charging and the charge port light pulses green, the charge cable may not have been fully inserted. The latch may not have engaged during previous attempts, because the cable was not fully inserted, even though it may have appeared to be. AC charging should no longer be limited and DC Fast Charging / Supercharging should be possible.
- If charging is still limited or the vehicle does NOT charge, inspect the charge port inlet and the charge cable connector for

any obstructions (use flashlight as necessary). Debris, and/or foreign objects present in the charge port inlet or the charge cable connector can prevent the charge cable from being fully inserted and the charge port latch from engaging. If any obstruction is found:

1. Remove the debris / foreign object.
2. Try re-inserting the cable into the inlet. AC charging should no longer be limited and DC Fast Charging / Supercharging should be possible.

Service should only be scheduled if any of the following conditions are present:

- This alert has appeared / remains present when the charge cable is confirmed to be fully inserted during charging.
- This alert has appeared / remains present during charging after any inlet or connector obstruction has been removed or no obstruction was found.

For more information on charging, see [Charging Instructions](#) on page 162.

## Regenerative braking temporarily reducedWill improve as vehicle is driven(DI\_a201)

Regenerative braking performance has been temporarily reduced to below 65% of its full capacity. The exact reduction is indicated by the dashed lines on the power meter:

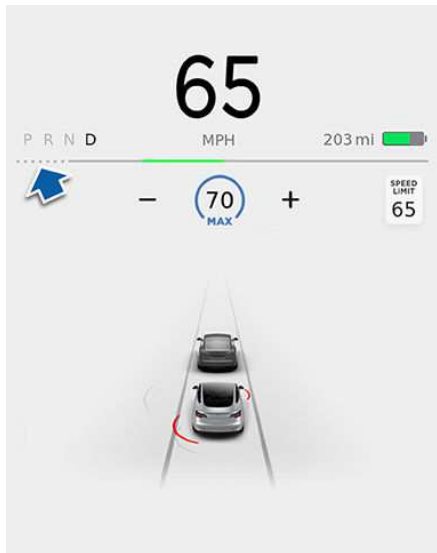

While this alert is present, the deceleration rate of the vehicle due to regenerative braking will be reduced and more brake pedal application will be required to slow the vehicle (similar to what is needed in a gas-powered, non-electric, vehicle).

This alert is expected under the following conditions:

- Battery is near full charge:
  - Regenerative braking is reduced when the battery is at 95% charge or higher.
- Battery is cold:
  - The battery may not be warm enough for full regenerative braking performance (possibly at the beginning of a drive).
  - In extremely cold climates, this alert may remain present indefinitely and regenerative braking may remain reduced, as driving the vehicle may not warm the battery enough to fully restore performance.

Typically, driving will clear this alert because it will reduce the battery charge level below 95% and sufficiently warm the battery.

This is a completely normal part of vehicle operation and should not cause alarm. The notice on the screen is for your information only.

For more information on regenerative braking, see the Regenerative Braking section in the Owner's Manual. [Regenerative Braking](#).

## Unable to chargeCheck charging equipment(CP\_a057)

Charging was interrupted because the external charging equipment has reported a fault that prevents the vehicle from charging.

Inspect the external charging equipment and look for status lights, displays, or other status indicators on the equipment. Consult the equipment owner's manual for further troubleshooting instructions.

Try charging the vehicle with different charging equipment or at a different charging station.

- If the vehicle starts to charge, the issue was likely with the equipment.
- If the vehicle still does not charge, the issue may be with the vehicle.

Service should ONLY be scheduled if:

- You have tried charging with different charge equipment / at different stations.
- This alert has appeared during every charging attempt.

For more information on troubleshooting Mobile Connector or Wall Connector status lights, refer to the product's Owner's Manual. If using other external charging equipment, refer to the manufacturer's provided documentation for troubleshooting tips.

## Tire pressure lower than recommendedCheck tire pressure and refill as needed(UI\_a014)

This alert does NOT indicate that there is a flat tire.

The tire pressure monitoring system (TPMS) has detected that the air pressure in one or more of your tires is at least 20% lower than the recommended cold tire pressure. This recommended pressure should be displayed on the Tire and Loading information label.

See the Maintaining Tire Pressures section of [Tire Care and Maintenance](#) on page 170 for detailed information on how to keep the tires properly inflated.

This alert may appear in cold weather because the tire pressure decreases when cold.



- Although drops in tire pressure are expected in colder weather, air should still be added to maintain the recommended cold tire pressure.
- The alert may clear as the vehicle is driven. This is because the tires will warm up and the tire pressure will increase.
  - Even if the alert clears, the tires should still be refilled with air once they have cooled. The recommended cold tire pressure should be maintained.

If you repeatedly see this alert for the same tire, have the tire inspected for a slow leak.

For more information on tire pressure and inflation, see the Tire Care and Maintenance section in the Owner's Manual. [Tire Care and Maintenance](#) on page 170.

## **12V battery requires service** **Replace 12V battery soon**(VCFRONT\_a182)

The 12V battery has aged or degraded and needs to be replaced.

It is recommended to replace the battery at your earliest convenience. In the meantime, continue normal use of the vehicle.

The vehicle is still OK to drive with this alert present, for a period of time. However, if you continually delay the 12V battery replacement, the vehicle may eventually not have enough power to start or restart.

If the 12V battery is too low to turn on the vehicle or open the doors, follow the jump start instructions in the Owner's Manual. [Jump Starting the 12V Battery](#).

For more information on the battery system, see the Battery Information section of the Owner's Manual. [Battery Information](#) on page 160.

## **Electrical system power** **reduced****Vehicle may shut down** **unexpectedly**(VCFRONT\_a192)

The electrical system cannot maintain the voltage required to support all vehicle features.

If you drive the vehicle while this alert is present, certain features may be disabled or function at a reduced level due to the low voltage. It is also possible the vehicle will shut down unexpectedly.

Try turning off non-critical features, like seat heaters or cabin fans, to help the vehicle maintain electrical power for as long as possible.

Eliminating or reducing usage of non-critical features may allow the vehicle to reach its destination without shutting down, although this is not guaranteed.

Schedule service before your next planned drive. The vehicle may shut down unexpectedly or may not restart without service.



## A

- ABS (Anti-lock Braking System) [68](#)
- absolute speed limit [116](#)
- access panel, removing [181](#)
- accessories
  - plugging into power socket [25](#)
- adjacent lane speed [110](#)
- aero covers [173](#)
- air circulation [128](#)
- air conditioning [127](#)
- air distribution [128](#)
- air filter [130](#)
- air vents [129](#)
- airbags [43](#)
- alarm [145](#)
- all-season tires [176](#)
- Always Show Estimated Round Trip Energy [135](#)
- ambient lights [60](#)
- anti-lock braking (ABS) [68](#)
- application launcher [4](#)
- audio
  - equalizer [140](#)
  - immersive sound [140](#)
  - playing files [138](#)
  - steering wheel scroll button [52](#)
  - volume control [138](#)
- auto fold [54](#)
- auto high beam [61](#)
- Auto Lane Change [93](#)
- auto tilt [54](#)
- AUTO wipers [67](#)
- automatic emergency braking [114](#)
- automatic navigation [132](#)
- Autopark [101](#)
- autopilot
  - blind spot collision warning [110](#)
  - side collision warning [110](#)
  - staying inside lane markings [110](#)
- Autopilot
  - Auto Lane Change [93](#)
  - automatic emergency braking [113](#)
  - Autopark [101](#)
  - Autosteer [91](#)
  - collision avoidance assist [113](#)
  - forward collision warning [113](#)
  - Navigate on Autopilot [94](#)
  - overtake acceleration [85](#)
  - overview [82](#)
  - speed assist [116](#)
  - speed limit warning [116](#)
  - staying within speed limits [116](#)
  - Summon [103](#)
  - Traffic-Aware Cruise Control [85](#)
- Autopilot components [82](#)
- Autosteer [91](#)
- average range [76](#)

## B

- backup camera [77](#)
- battery (12V)
  - complete discharge [160](#)
  - specifications [193](#)
- Battery (high voltage)
  - care of [160](#)
  - coolant [181](#)
  - specifications [193](#)
  - temperature limits [160](#)
- battery (key), replacing [12](#)
- blind spot collision warning [110](#)
- blind spot collision warning chime [110](#)
- Bluetooth
  - devices, playing audio files from [140](#)
  - general information [141](#)
  - phone, pairing and using [141](#)
- body repairs [184](#)
- body touch up [178](#)
- brakes
  - automatic in emergencies [114](#)
  - fluid level [182](#)
  - overview of [68](#)
  - specifications [191](#)
- Bumper Clearance (Summon) [103](#)

## C

- cabin air filter [130](#)
- cabin camera [27](#)
- cabin temperature control [127](#)
- Calendar app [143](#)
- calibrating windows [17](#)
- California Proposition [65](#) [211](#)
- camera (rear view) [77](#)
- cameras (autopilot) [82](#)
- Camp Mode [130](#)
- car cover [179](#)
- car washes [177](#)
- card [10](#)
- cargo area [19](#)
- cargo volume [189](#)
- carpets, cleaning [178](#)
- CCS (Combo) [159](#)
- CE certifications [213](#)
- CHAdemo [159](#)
- chains [176](#)
- change of ownership [126](#)
- charge port [162](#)
- charge port light [164](#)
- charge port manual release [163](#)
- charge port release cable [163](#)
- charging
  - charge settings [165](#)
  - charging status [165](#)
  - components and equipment [158](#)
  - instructions [162](#)



- charging (*continued*)
  - public charging stations [159](#)
  - scheduling [165](#)
- charging locations, finding [134](#)
- child protection
  - disabling rear window switches [17](#)
- child seats
  - installing and using [36](#)
- child-protection locks [16](#)
- cleaning [177](#)
- climate controls [127](#)
- coat hangers [26](#)
- cold weather driving [80](#)
- collision avoidance assist [113](#)
- connecting to Wi-Fi [152](#)
- console
  - 12V power socket [25](#)
  - opening [23](#)
  - rear [25](#)
  - USB ports [23](#)
- consumption chart [76](#)
- contact information
  - roadside assistance [202](#)
  - Tesla [212](#)
- copyrights [208](#)
- cruise control [85](#)

## D

- dashboard overview [2](#)
- Dashcam [78](#)
- data recording [210](#)
- data sharing [210](#)
- declarations of conformity [213](#)
- delivery mileage [211](#)
- devices
  - Bluetooth, playing audio files [140](#)
  - connecting [23](#)
  - playing audio files from [140](#)
- dimensions [188](#)
- Dog Mode [130](#)
- dome (map) lights [60](#)
- door handles [14](#)
- door labels [186](#)
- doors
  - Child Lock [16](#)
  - exterior door handles [14](#)
  - interior locking and unlocking [15](#)
  - keyless entry [14](#)
  - locking [14](#)
  - opening from exterior [14](#)
  - opening from interior [14](#)
  - Unlock on Park [16](#)
  - unlocking [14](#)
- doorsfunction
  - Walk-Away Door Lock [15](#)
- drive away locking [16](#)
- Drive gear [58](#)

- driver
  - profiles [50](#)
- driving
  - seating position [28](#)
  - starting [56](#)
  - tips to maximize range [76](#)

## E

- Easter Eggs [207](#)
- easy entry, driver profile [50](#)
- EDR (event data recorder) [210](#)
- electric parking brake [70](#)
- emergency braking [113](#)
- emergency flashers [62](#)
- emission label [185](#)
- energy
  - gained from regenerative braking [69](#)
  - range information [64](#)
- Energy app [76](#)
- energy use predictions (navigating) [135](#)
- Erase & Reset [126](#)
- event data recording [210](#)
- exterior
  - car cover [179](#)
  - cleaning [177](#)
  - dimensions [188](#)
  - lights [60](#)
  - overview [3](#)
  - polishing, touch up, & repair [178](#)

## F

- factory defaults, restoring [126](#)
- factory reset [126](#)
- fan speed, interior [128](#)
- favorites (Media Player) [139](#)
- Favorites (navigation) [133](#)
- FCC certifications [213](#)
- features, downloading new [153](#)
- firmware (software) updates [153](#)
- flash drives, playing audio files from [140](#)
- flashers, warning [62](#)
- floor mats [179](#)
- fluids
  - replacement intervals [168](#)
  - reservoirs, checking [181](#)
- fog lights [60](#)
- forward collision warning [113](#)
- front passenger detection [45](#)
- front trunk [20](#)

## G

- garage doors, opening [149](#)
- gates, opening [149](#)



GAWR [186](#)  
 gears [58](#)  
 glovebox [23](#)  
 Gross Axle Weight Rating [186](#)  
 Gross Vehicle Weight Rating [186](#)  
 ground clearance [188](#)  
 GVWR [186](#)

## H

hazard warning flashers [62](#)  
 head supports [30](#)  
 headlights  
   after exit [62](#)  
   controlling [60](#)  
   high beams [61](#)  
 heating [127](#)  
 high beam headlights [61](#)  
 high voltage  
   Battery specifications [193](#)  
   components [158](#)  
   safety [168](#)  
 hills, stopping on [75](#)  
 Home location [136](#)  
 HomeLink  
   programming and using [149](#)  
   when using Summon [103](#)  
 hood [20](#)  
 horn [53](#)  
 hub caps [173](#)

## I

I'm Feeling Lucky, Hungry [132](#)  
 IC certifications [213](#)  
 identification labels [185](#)  
 instant range [76](#)  
 interior  
   cleaning [178](#)  
   dimensions [188](#)  
   lights [60](#)  
   overview [2](#)  
   temperature control [127](#)  
 internet radio [138](#)  
 intrusion detection [145](#)

## J

J1772 [159](#)  
 jacking [183](#)  
 jump starting [205](#)

## K

Keep Climate On [130](#)

key  
   FCC and IC certifications [213](#)  
   replacing battery [12](#)  
 key card [10](#)  
 keyless entry [14](#)  
 keys  
   adding key cards and phones [12](#)  
   deleting key cards and phones [12](#)  
   displaying a list of [12](#)  
   overview [9](#)

## L

label  
   Tire and Loading Information [186](#)  
   vehicle certification [186](#)  
 lane assist [110](#)  
 lane change, automatic [93](#)  
 lane departure warning [110](#)  
 LATCH child seats, installing [39](#)  
 liftgate  
   adjust opening height [18](#)  
   opening [18](#)  
 lifting [183](#)  
 lights  
   hazard warning [62](#)  
   headlights after exit [62](#)  
   turn signals [62](#)  
 load limits [186](#)  
 location tracking [132](#)  
 locking [14](#)  
 lug nut covers [174](#)  
 lumbar adjustment [28](#)

## M

maintenance  
   brake fluid, checking [182](#)  
   cleaning [177](#)  
   daily checks [168](#)  
   fluid replacement intervals [168](#)  
   monthly checks [168](#)  
   panel, removing [181](#)  
   replacing wiper blades [180](#)  
   service intervals [168](#)  
   tires [170](#)  
   washer fluid, topping up [182](#)  
   washer jets, cleaning [180](#)  
 map orientation [132](#)  
 map updates [137](#)  
 mats [179](#)  
 media [138](#)  
 mileage upon delivery [211](#)  
 mirrors [54](#)  
 mobile app [155](#)  
 Mobile Connector  
   description [159](#)



Mobile Connector (*continued*)  
    using 162  
modifications 184  
motor specifications 190  
my car does what? 207

## N

naming 125  
Navigate on Autopilot 94, 97  
navigating 132, 133  
NCC certifications 213  
Neutral gear 58  
NHTSA, contacting 212

## O

Obstacle-Aware Acceleration 113  
occupancy sensor 45  
occupant classification 47  
odometer 8  
off-road mode 72  
offset from speed limit 116  
Online Routing 136  
opening hood without power 205  
overhang dimensions 188  
overtake acceleration 85  
Owner Information, about 208

## P

Park Assist 73  
Park gear 58  
parking brake 70  
parking, using Autopark 101  
parking, using Summon 103  
parts replacement 184  
passenger detection 45  
passenger front airbag 45  
personal data, erasing 126  
phone  
    adding as a key 12  
    authenticating as a key 9  
    removing as a key 12  
    using 141  
phone app 142  
phone key 9  
PIN 51  
PIN to Drive 145  
power cycling 56  
power socket 25  
power windows 17  
powering on and off 56  
Proposition 65 211  
public charging stations 159

## R

radar 82  
radio 138  
Radio Frequency information 213  
range  
    driving tips to maximize 76  
    regenerative braking 69  
range assurance 76  
Re-route 136  
reading light 26  
rear seats, adjusting and folding 29  
rear view camera 77  
rear window switches, disabling 17  
recent (Media Player) 139  
Recents (navigation) 133  
recording videos 78, 146  
regenerative braking 69  
relative speed limit 116  
release notes 154  
restarting the touchscreen 56  
Reverse gear 58  
RFID transponders 184  
roadside assistance 202  
roof racks 187  
rotating tires 171  
Round Trip Energy (navigating) 135

## S

safety defects, reporting 212  
safety information  
    airbags 49  
    child seats 41  
    seat belts 34  
schedule service 155  
scheduled charging 167  
scheduled departure  
    using 167  
seat belts  
    cleaning 178  
    in a collision 33  
    overview of 32  
    pre-tensioners 33  
    wearing when pregnant 33  
seat covers 31  
seat heaters 127, 129  
seating capacity 186  
seats  
    heaters 127  
security settings 145  
sensors 82  
Sentry Mode 145  
service data recording 210  
service intervals 168  
Settings, erasing 126  
shifting gears 58  
Show Calendar Upon Entry 143



- Side Clearance (Summon) 103
- side collision warning 110
- slip start 72
- Smart Summon 106
- smartphone
  - authenticating as a key 9
  - removing as a key 12
- software reset 126
- software update preferences 153
- software updates 153
- software version 8
- specifications
  - 12V battery 193
  - brakes 191
  - cargo volume 189
  - dimensions 188
  - exterior 188
  - High Voltage Battery 193
  - interior 188
  - motor 190
  - steering 191
  - subsystems 190
  - suspension 193
  - tires 195
  - transmission 191
  - weights 189
  - wheels 194
- speed assist 116
- Speed Limit Mode 126
- speed limit warning 116
- stability control 72
- starting 56
- steering specifications 191
- steering wheel
  - adjusting position 52
  - adjusting sensitivity 52
  - buttons 52
  - lights, controlling 60
  - scroll buttons 52
- steering, automatic 91
- streaming radio 138
- streaming services 138
- summer tires 176
- Summon 103
- Summon Distance 103
- supercharging
  - described 167
  - idle fees 167
  - pay-per-use fees 167
- suspension specifications 193

## T

- telematics 210
- temperature
  - Battery (high voltage), limits 160
  - cabin, controls for 127
  - outside 64

- temperature (*continued*)
  - tires 198
- Teslacam 78
- tie-down straps 205
- tilt/intrusion detection 145
- Tire and Loading Information label 186
- tire noise 176
- Tire Pressure Monitoring System
  - overview of 174
- tire pressures, checking 170
- tires
  - all-season 176
  - balancing 171
  - chains 176
  - inspecting and maintaining 171
  - pressures, how to check 170
  - quality grading 198
  - replacing 172
  - replacing a tire sensor 175
  - rotation 171
  - specification 195
  - summer 176
  - temperature grades 198
  - tire markings 196
  - traction grade 198
  - treadwear grade 198
  - wheel configuration 170
  - winter 176
- toll system transponders, attaching 184
- torque specifications 190
- touch up body 178
- touchscreen
  - cleaning 178
  - overview 4
  - restarting 52
  - software updates 153
- towing instructions 203
- TPMS
  - overview of 174
- Tracking Disabled 132
- traction control 72
- trademarks 208
- Traffic-Aware Cruise Control 85
- transmission specifications 191
- transponders, attaching 184
- Transport Canada, contacting 212
- Transport Mode 204
- transporting 203
- trip chart 76
- Trip Planner 136
- trunk, front 20
- trunk, rear 18
- turn signals 62

## U

- ultrasonic sensors 82
- uniform tire quality grading 198





- Unlock On Park [16](#)
- unlocking [14](#)
- USB devices
  - connecting [23](#)
  - playing audio files from [140](#)
- USB flash drive [145](#)
- USB ports [23](#)

## V

- Valet mode [51](#)
- vehicle certification label [186](#)
- Vehicle Hold [75](#)
- Vehicle Identification Number (VIN) [185](#)
- vehicle loading [186](#)
- ventilation [129](#)
- videos and recording [78](#), [146](#)
- VIN (Vehicle Identification Number) [185](#)
- volume control [4](#)
- volume control (media) [138](#)

## W

- Walk-Away Door Lock [15](#)
- Wall Connector [159](#)
- warning flashers [62](#)
- washer fluid, topping up [182](#)
- washer jets, cleaning [180](#)
- washers, using [67](#)
- weight specifications [189](#)
- wheel chocks [205](#)
- wheels
  - aero covers, removing and installing [173](#)
  - alignment [171](#)
  - lug nut covers, removing and installing [174](#)
  - replacing [172](#)
  - specifications [194](#)
  - torque [194](#)
- Wi-Fi, connecting to [152](#)
- windows, calibrating [17](#)
- windshield washer fluid, topping up [182](#)
- winter tires [176](#)
- wiper blades, replacing [180](#)
- wipers, using [67](#)
- Work location [136](#)

**TESLA**

PUBLISHED MARCH 13, 2020